

CINTEC

REINFORCEMENT SYSTEMS



The Orthopaedic Surgeons for the Construction Industry

Cintec Engineered Cementitious Grouted Anchoring Systems for Earth and Water Retaining Walls

Email: solutions@cintec.com

www.cintec.com



Copyright ©

Please do not participate or encourage piracy of copyrighted material in violation of Cintec's rights.

Patents

Since 1965 Cintec has strived to become the world leader in the design and manufacturing of project specific designed cementitious anchoring and reinforcement systems. **Patents** have been obtained worldwide and additional patents have been applied for and are pending. A partial list of Patents / Patents pending includes, but is not limited to: 2245121, 2764006, 0090895, 5216857, 116188, 1210196, DE19609514, 3608775, DE2315859



NOTICE: THESE DRAWINGS (INCLUDING THE DESIGN AND THE TECHNICAL INFORMATION SHOWN HEREIN) BELONGS TO AND IS THE COPYRIGHT OF CINTEC REINFORCEMENT SYSTEMS ("Cintec") AND ACCORDINGLY THE PERSON, FIRM, COMPANY OR ORGANIZATION TO WHOM HAVE BEEN PROVIDED MAY NOT COPY, RE-PRODUCE OR MAKE ANY USE OF THE DRAWINGS (INCLUDING THE DESIGN OR ANY OF THE TECHNICAL INFORMATION SHOWN HEREIN) OR SHOW OR OTHERWISE PROVIDE THE DRAWING (OR THE SAID DESIGN OR ANY OF THE TECHNICAL INFORMATION) TO ANY THIRD PARTY WITHOUT CINTEC'S SPECIFIC PERMISSION.



Copyright © Cintec International Ltd 2021 All rights reserved. NO part of this publication may be reproduced or transmitted in any form or by means, electronic or mechanical, including photocopying, recording or any information storage or retrieval system without prior written approval from Cintec.

COPYRIGHT

This manual is the copyright of Cintec America Inc, Cintec Reinforcement System Ltd and Cintec International Limited.

No part shall be reproduced in any media format without the express permission of Cintec International Limited or its affiliates.

INDEX	PAGE
<u>Section 1</u>	4
Salient Points:	
<u>Section 2</u>	20
Contractors Notes (Including MSDS):	
<u>Section 3</u>	43
Ground Anchors:	
<u>Section 4</u>	55
<u>PART 1</u>	56
Earth Retaining Walls	
Case Histories	
Strengthening of Parapet Walls	85
<u>PART 2</u>	89
Marine Walls	
Case Histories	

SECTION 1



Salient Points for use of Cintec Reinforcement Systems



© CINTEC FEB 2021

Email: solutions@cintec.com

www.cintec.com



Salient Points for Use of Cintec Reinforcement Systems

Cintec's anchoring and reinforcement system "Presstec" grout is **CEMENTATIOUS**. This all natural, proprietary grout is of high strength with no additives and very good bond capacity (65 psi). See MSDS sheet Page 16.

Cintec's anchoring and reinforcement system can be **INSTALLED IN WET OR DUSTY CONDITIONS**. This is very important, as many sites do not provide "ideal" installation conditions with respect to moisture, dust presence or precision hole creation and the failure of the installer to create these ideal conditions may lead to anchoring failure with other systems. The presence of water or dust or even less than exact hole diameters is of no consequence – in fact, Cintec anchors and reinforcement can and have been successfully installed under water.

Cintec's anchoring and reinforcement system can only be **INSTALLED BY CINTEC TRAINED AND CERTIFIED** installers. As part of our quality control, extensive training of all installers is mandatory by Cintec personnel. Cintec product is only available to the project via Cintec Reinforcement Systems thus eliminating the possibility of contractors obtaining product independently and installing with less than qualified people.

Cintec's anchoring and reinforcement system has been **TESTED TO BE FIREPROOF**. A major and common application of Cintec anchors is for seismic upgrading and as such the fireproof characteristics of this product are critical. Often, earthquakes result in fire and any anchoring system not fireproof and resistant to high heat conditions could easily result in anchoring failure and possible human injury or death.

Cintec's anchoring and reinforcement system is **PULLOUT CAPACITY ENGINEERED** to required load capacity. All Cintec anchors and reinforcements are custom made and project specific to address required capacities. We do not use a "one size fits all" approach in selection and manufacturing of anchoring solutions. Please visit the engineering aid section following for extensive information and design criteria.

Cintec's anchoring and reinforcement system has been **TESTED TO 150 FREEZE/THAW CYCLES**. Public Works and Government Services Canada (PWGSC) commissioned and paid for thorough testing of Cintec product for Pull Out and Freeze Thaw by the University of Manitoba – Structural Department. As a result, Cintec product is "sole sourced" on many federal projects.

Cintec's anchoring and reinforcement system provides both **ADHESIVE AND MECHANICAL** attachment. Unlike other systems that offer only one or the other attachment system, Cintec's patented system provides adhesive attachment through it's grout bonding and mechanical through it's expandable sock system.

Cintec's anchoring and reinforcement system has been **TESTED TO RESIST SEISMIC** action. As stated earlier, seismic upgrading of structures – worldwide is a major and common application of the Cintec system.

Cintec's anchoring and reinforcement system **DOES NOT RESULT IN BRITTLE FAILURE**. Although very important, this factor is often overlooked in anchoring solutions. Simply stated, brittle failure is experienced in systems that hold... then fail. Cintec's progressive failure (by design) allows for release when critical loads are reached but not instant total failure. A rough analogy might be the difference between a blow out versus a slow leak in a car tire.

For more information see ENGINEERS GUIDE available at www.cintec.com

CINTEC – GENERAL SPECIFICATIONS

- ✓ Cintec's anchoring and reinforcement system "Presstec" grout is **CEMENTATIOUS**.
- ✓ Cintec's anchoring and reinforcement system can be **INSTALLED IN WET OR DUSTY CONDITIONS**.
- ✓ Cintec's anchoring and reinforcement system has been **TESTED TO BE FIREPROOF**.
- ✓ Cintec's anchoring and reinforcement system is **PULLOUT CAPACITY ENGINEERED** to required load capacity.
- ✓ Cintec's anchoring and reinforcement system has been **TESTED TO 150 FREEZE/THAW CYCLES**.
- ✓ Cintec's anchoring and reinforcement system provides both **ADHESIVE AND MECHANICAL** attachment.
- ✓ Cintec's anchoring and reinforcement system has been **TESTED TO RESIST SEISMIC** action.
- ✓ Cintec's anchoring and reinforcement system **DOES NOT RESULT IN BRITTLE FAILURE**.



Pull Out / Freeze Thaw Testing

The ISIS Canada Research Network (ISIS) was established in 1995 under the leadership of Dr. Sami Rizkalla to advance the civil engineering profession in Canada to a world leadership position through the use of advanced composite materials and the application of structural health monitoring (SHM) to civil infrastructure, such as bridges. The Network—headquartered at the University of Manitoba—comprises 14 Canadian universities (five of them western), 30 principal investigators (engineering professors), 185 researchers and 50 to 75 government and industry partners.

In 2012 Public Works and Government Services Canada (PWGSC) commissioned the ISIS Canada Research Network to extensively test the Cintec Reinforcement System as reassurance of the products suitability for use in its seismic upgrades and restorative efforts with respect to its structures. Cover Left The main objective of the study outlined by PWGSC was to evaluate the performance of Cintec anchors in a material similar to the one found in the outer wythe of the West Block building, while accounting for the influence of weather conditions in the Canadian climate. The objective translates into two major benchmarks for the program:

[1] **CONDITIONING** – subject the samples to weathering criteria listed in the relevant North American Standards with consideration for other International standards.

[2] **TESTING** – evaluating the pullout behaviour of anchors in both control and conditioned samples under static loads.

Successful test results were responsible for the following comments made by the testing principals.

"This ductile behaviour provided by the Cintec repair technique is strongly advantageous because it provides ample warning of impending failure while sustaining a surcharge comparable to the capacity of the anchor." **

"this damage is contained in the vicinity of the rod as well as at the top of the grouted hole. It does not extend towards the interface to affect the bond between the fabric sock and the stonework. The result underlines another advantage of the Cintec anchorage system for rehabilitating structures similar to the West Block building on Parliament Hill." **

"the Cintec rehabilitation technique is resilient despite the consideration of thermal weathering." **

** Dr Hugues M. Vogel, E.I.T & Dr. Aftab Mufti, CM, P.Eng.



Fire Testing

BRE is a world leading multi-disciplinary building science centre with a mission to improve the built environment through research and knowledge generation. Building a better world together.

"In the latest test in our fire test rig with a static dead load on each tie of 1.3 kN your tie survived a two-hour test without failure of any of the three replicate samples." *

"All three samples are now placed in the upper half of the wall and would have reached several hundred degrees in the part of the tie nearest the fire face." *

*This indicates that this tie system can, when installed using the correct techniques, be recommended for repair work to buildings having a fire period requirement of up to 2hrs. *

* R. C. de Vekey - Head of Masonry Structures Section, Structural Design Division, Geotechnics and Structural Group



Seismic Testing

JOINT RESEARCH CENTRE (JRC) is the European Commission's science and knowledge service which employs scientists to carry out research in order to provide independent scientific advice and support to EU policy. Located in Ispra, Northern Italy it is firmly established as one of Europe's leading research campuses.

Physical testing aimed specifically at seismic loading has taken place in the reaction wall laboratory of the Joint Research Centre in Italy.

Pseudo-dynamic and cyclic tests were carried out on a full-scale model of part of the cloisters of the São Vicente de Fora Monastery, in Lisbon - Portugal. The research was aimed at characterizing the non-linear behaviour of stone block structures under earthquake loading and also at assessing the effectiveness of retrofitting Cintec anchors.

The retrofitted model demonstrated that the continuous bond Cintec anchors performed far better than pre-compression ties.

It was apparent that observed cracking was 'better distributed' within the structure. The tests provided strong evidence for the 'applicability and effectiveness of such a kind of retrofitting in terms of deformation capacity and strength of the model.'



THE STEEL



DESIGNED REINFORCEMENT AND ANCHORING SOLUTIONS

The anchor or reinforcement consists of three components - steel, sock and grout. The first is the reinforcing bar which comes in a variety of forms such as solid, hollow, round or square. Steel configuration is determined by project requirements such as load and application. It is, in most cases, stainless-steel Type 304 but we also use Type 316 for greater corrosion resistance and Type 2205 where higher strengths are needed. Cintec manufactures to the specific requirements of the project and therefore may use other types of stainless steel as well.

For more information see ENGINEERS GUIDE available at www.cintec.com

THE SOCK



DESIGNED REINFORCEMENT AND ANCHORING SOLUTIONS

The second component of the Cintec Reinforcement System is the sock. The sock is a woven polyester sleeve that can expand horizontally but not longitudinally. Redundant to the process once inflated and the grout has set, the sock is critical in the installation procedures to contain and retain the grout. Wetting the sock, prior to inflation, “conditions” it to allow the bonding grout milk to flow through yet traps the micro cement particles and prevents uncontrolled grout flow. This facilitates an even expansion along its entire length for bonding with substrate where contact is made and expansion of system into voids when possible. Manufactured by Cintec, to stringent standards, this proprietary sock is available in 1” to 12” diameter and unlimited length.

For more information see ENGINEERS GUIDE available at www.cintec.com

THE GROUT



NON SHRINK GOOD STRENGTH

DESIGNED REINFORCEMENT AND ANCHORING SOLUTIONS

The grout is the third component of the Cintec Reinforcement System and is a specially engineered Mineral Bound Injection Grout with no artificial additives. This cementitious grout consists of very fine particles (micro cement) that can be injected over considerable distances. It is non shrink, non expansive and impervious to absorption when set. The patented grout is manufactured in Germany to Cintec standards. Stringent mixing and injection procedures are provided as part of Cintec's Quality Control program and must be implement by Cintec certified installers only. Use of any other grout, in the Cintec Reinforcement system, that has not been pre-approved by Cintec is not allowed and voids any warranty.

For more information see ENGINEERS GUIDE available at www.cintec.com

PRESSTEC © GROUT BOND QUICK CALCULATION

GROUT - PRESSTEC 2000 ©

TYPICAL MEAN VALUES

	1 DAY	7 DAY	28 DAY
TENSION	835 psi / 5.75 Mpa	1060 psi / 7.3 Mpa	1150 psi / 7.9 Mpa
COMPRESSION	6550 psi / 45 Mpa	8840 psi / 61 Mpa	9625 psi / 66 Mpa

APPROXIMATELY 70% AFTER 24 HOURS

PULL OUT BOND STRENGTH

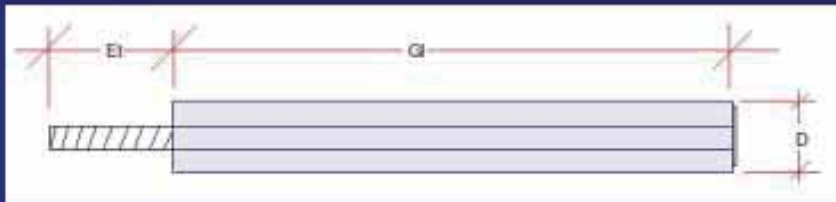

Bond capacity = $\pi \times D \times L \times 65\text{lbs}$

Where D is core hole diameter, G is grouted length and 65lbs is bond per square inch

Assume: D is 2 inch, G is 6 inches

Therefore: $3.14 \times 2 \times 6 \times 65$

2,450 lbs bond pull out for this anchor.

DESIGNED REINFORCEMENT AND ANCHORING SOLUTIONS

For more information see ENGINEERS GUIDE available at www.cintec.com

MOCK-UP of CINTEC ANCHOR or REINFORCEMENT

Drilled hole usually double, or greater, than body diameter

Main body available as square or circular hollow section or solid bar profile of various stainless steel materials

Woven polyester sock contains and retains Presstec® grout around anchor body and allows bonding to substrate

Grout injection (40 psi +/-) moulds anchor / reinforcement to the shapes and spaces within walls / structure

Inner wall substrate – in this case rubble fill but often other material

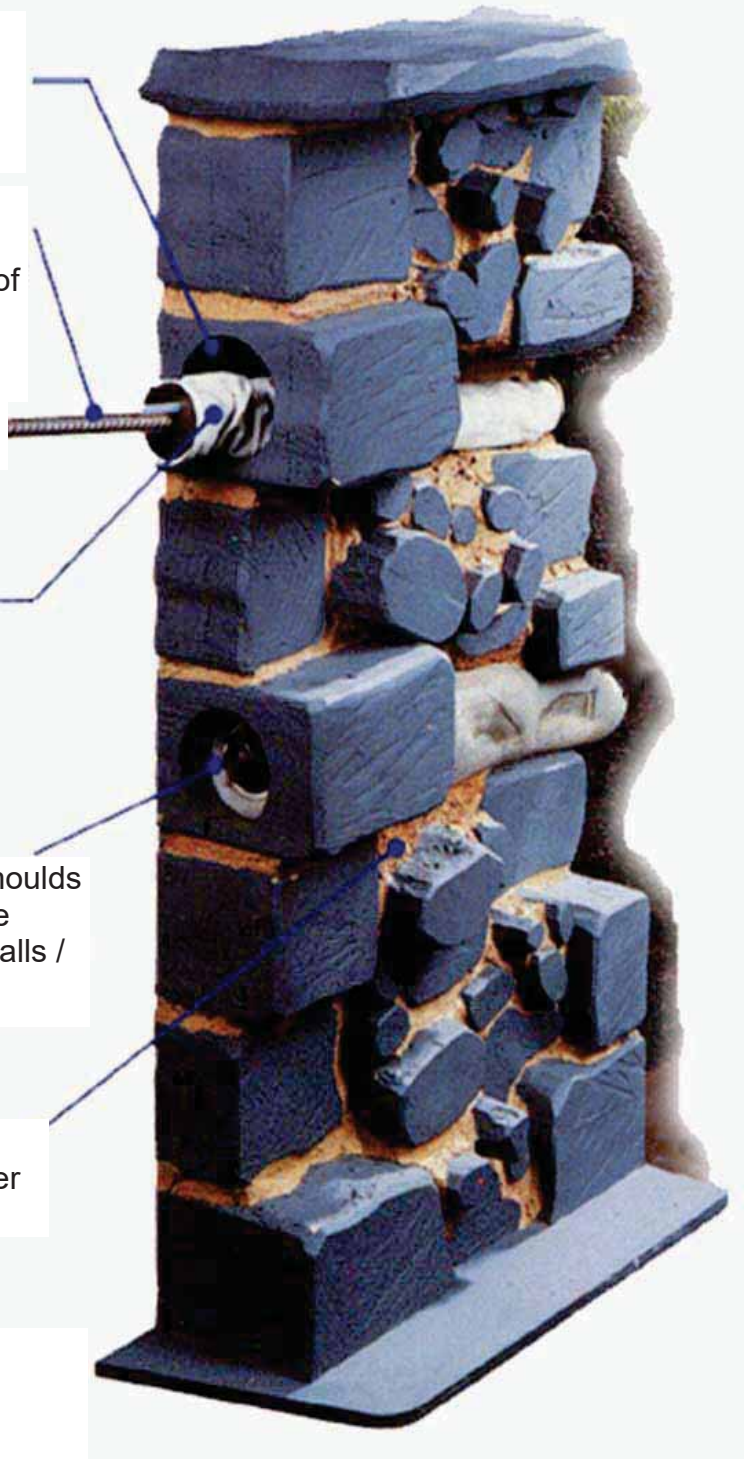

For more information see ENGINEERS GUIDE available at www.cintec.com

IN-SITU CINTEC ANCHOR or REINFORCEMENT

ACTUAL PHOTO



The Cintec Reinforcement System attaches in two ways. When the sock, containing grout milk, is able to come in contact with the substrate it adheres with a bond strength of 65 psi. When the expanded sock is not able to contact the substrate then the low injection pressure causes the sock (grout) to expand horizontally into the void resulting in a mechanical attachment. The high compressive grout strength (9,000 psi) ensures an attachment with progressive failure rather than brittle failure potential.

For more information see ENGINEERS GUIDE available at www.cintec.com

PROJECT SPECIFIC ANCHORS

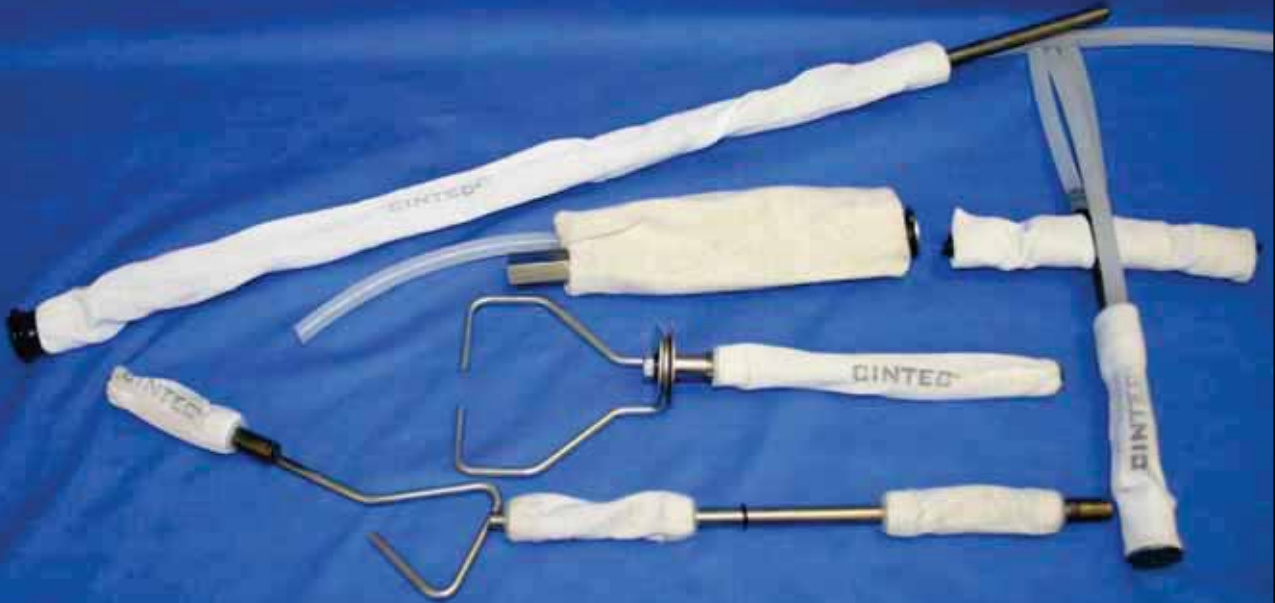

DESIGNED REINFORCEMENT AND ANCHORING SOLUTIONS

All Cintec anchors are custom made. Whatever the Engineer / Architect / Contractor requires to satisfy project needs is what we manufacture. Configuration is determined based on load requirements, application and site conditions. This customization ensures that specific project needs are satisfied as opposed to a compromised solution selection based on “off the shelf” availability.

For more information see ENGINEERS GUIDE available at www.cintec.com

CALCULATION OF ANCHOR DESIGN

Determine application: Is the anchor to act as a:

- A - Stitching anchor for brick or masonry (usually CHS but may be SRT for higher loads)
- B - Wall reinforcing anchor (usually SRT but may be HSS or other configuration)
- C - Wall anchor used for attaching to something i.e.: header, beam etc. (usually SRT but end treatments can be defined by Engineer/ Architect)

Determine loads to be placed on the anchor.

- A - Shear
- B - Tensile
- C - Bending Moment
- D - Pull Out (bond failure)

Substrate capacity will usually be less than designed anchor capacity.

Wall (substrate) thickness must be determined as anchor lengths are predicated on this information. Stitching anchors are usually 4" [100 mm] less in length than total wall thickness (embed length). Anchors used for attaching are usually wall thickness less 2" [50 mm] (embed length) plus the amount of protrusion needed for end treatment.

The following pages are from our Engineering Manual which can be found on our website www.cintec.com.

Page 63-66 – Locate stainless steel configuration (CHS, HHS or SRT) and pick size from table so that all values equal or exceed determined loads.

Page 86 – Hole diameter selected from table based on style and diameter of steel to be used. (Note length limitations)

Page 75- 82– Using the embed lengths and hole diameter previously found locate corresponding Pull Out Strength. Straight extrapolation for longer lengths is acceptable. If pull out is less than needed, diameter of cored hole may be increased.

The above is a good general determination of anchor needs. I should also caution you that any load other than direct tension pull out should be looked at by a Cintec engineer. A second opinion never hurts.

For more information see ENGINEERS GUIDE available at www.cintec.com

Cintec Generic SRT

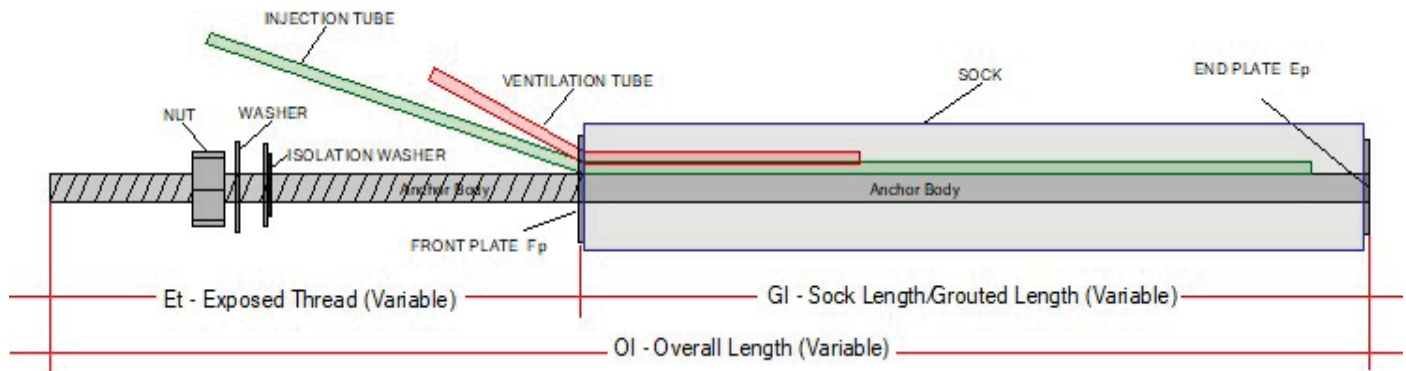

Accessories

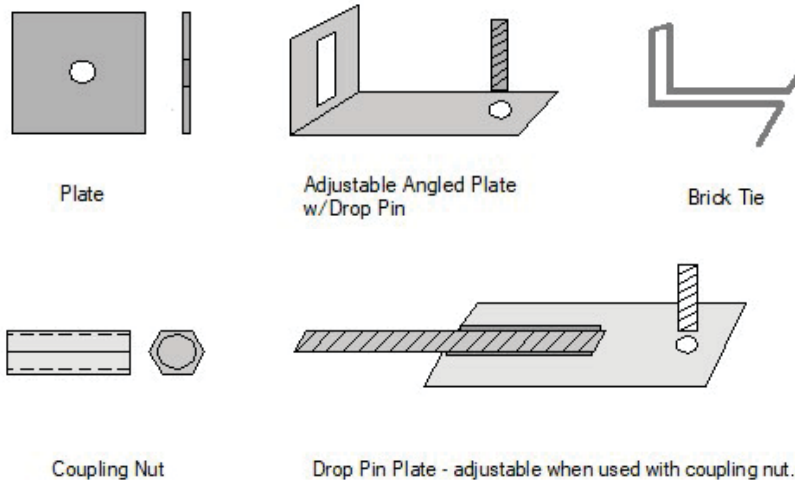

CINTEC TERMINOLOGY

Accessory - end treatment that can be attached to an anchor

Anchor Body - the steel part of the anchor. Usually stainless steel and may be hollow, solid round, square, or other configuration.

Nut - hexagonal with same ID as body and usually of same material.

Plate (End) - on most anchors. Usually 1/2" smaller diameter than the core/ sock diameter. Has hole in centre the size of body so it can be welded / thread-locked in place.

Plate (Front) - on some anchors. Usually 1/2" smaller diameter than the core/ sock diameter. Has hole in centre the size of body so it can be welded / thread-locked in place. May also have "port (s)" to accommodate injection / ventilation / other tubes.

Sock - polyester , woven tube usually size matched to the core hole diameter... but NOT always

Tube (Injection) - tube that is glued in place and used to INJECT the anchor sock. It is the longest tube if two or more tubes are present and identified with a sticker with green writing.

Tube (ventilation) - also called "emergency" allows air in system to escape and can also be used if absolutely necessary to inflate anchor. It is glued in place and is the shortest tube if two or more tubes are present and identified with a sticker with red writing.

Washer - also called flat or fender washer.

Washer (Isolation) - also called bonded washer, used to prevent galvanic action between dissimilar materials

For more information see ENGINEERS GUIDE available at www.cintec.com

WHAT “TYPE” TO USE

CHS



CHS (Circular Hollow Section)

Often referred to as a **STITCHING ANCHOR**. Stainless Steel 304 / 316. Body diameter of 3/8" (10mm) or 1/2" (12mm). They are typically installed perpendicular to wall face. Used primarily to consolidate exterior to interior masonry wall faces as well as multi-wyth brick. Installation in a 3/4" (20mm) or 1" (25mm) hole, respectively, with a length of no more than 39" (1000mm). Typically installed in a Domino 5 pattern. Various end treatments are possible for specific project requirements and applications.

SRT

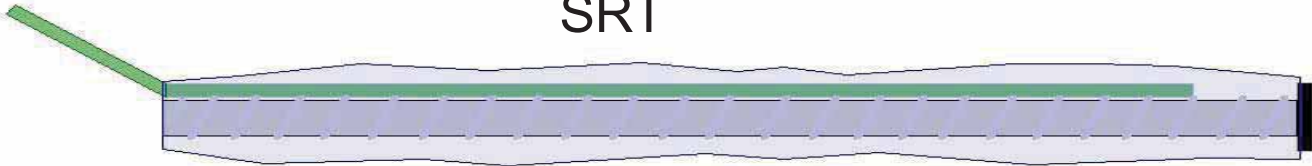

SRT (Solid Rod-Threaded)

Inplane or Reinforcement run parallel with the structures face and may be installed vertically, horizontally or on an incline. Stainless Steel 304 / 316 /2205 and 17-4PH are commonly used but other grades may be used per project requirements. Possibly the most widely used of the Cintec Reinforcement System, it's primary purpose is in strengthening, cladding stabilization and seismic upgrading. Body diameter of 1/4" (6mm) to over 2 1/2" (65mm) with sock / core hole diameters of 3/4" (20mm) to 12" (300mm). No length restrictions - longest to date 147' (4500mm). This "type" of reinforcement may be **Post Tensioned** using a 2 sock system. Application and purpose dictates sizing and various end treatments are possible for specific project needs.

SHS

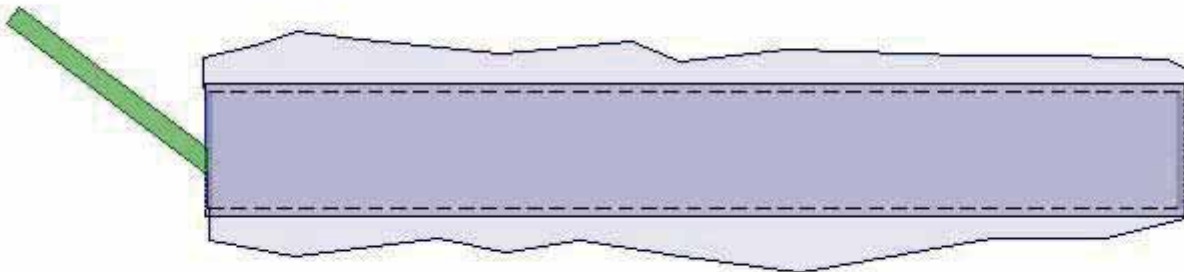

SHS (Square Hollow Section)

Moment Resisting, this body configuration is used where increased moment capacity is required while keeping the overall diameter of cored hole to a minimum. Stainless Steel 304 / 316 are commonly used but other grades may be considered per project requirements. It's primary purpose is as a support member and to transfer loads for applications such as shelf angles and joist attachment. Body diameter of 3/4" (20mm) to over 4" (100mm) with sock / core hole diameters of 1 1/2" (38mm) to 12" (300mm). No length restrictions. Application /purpose dictates sizing and various end treatments are possible for specific project needs.

For more information see ENGINEERS GUIDE available at www.cintec.com

PATENTS

Since 1965 Cintec has strived to become the world leader in the design and manufacture of project specific designed cementitious anchoring and reinforcement systems. PATENS have been obtained worldwide and addition patents have been applied for and are pending. A partial list of Patents / Patents pending includes, but is not limited to: 2245121, 2764006, 0090895, 5216857, 116188, 1210495, DE19609914, 3608775, DE2315859.

THE SOCK

The fabric sleeve is specially woven polyester based tubular sock with expansion properties to suit the diameter of the bore hole and substrate. The mesh of the sock is designed to contain the aggregates of the mixed grout, while still allowing the cement enriched water (milk) to pass through the sock both sizing and bonding to the substrate. The sock is manufactured in sizes from 20mm to 300mm in diameter and is adjusted to suit each individual application.

THE GROUT

Presstec grout is a cementitious grout, a factory produced mix with graded aggregates and other constituents which when mixed with water produce a pumpable grout that exhibits good strength with no shrinkage. Presstec is made in accordance with the following DIN standards, which are comparable to ASTM standards. **The Grout does not contain any resin binders.**
DIN EN 197-1. DIN EN 196. DIN EN 932. DIN 4226. DIN EN 933.
DIN EN 1097. DIN EN 1367. DIN 18555. & DIN 18557

For more information see ENGINEERS GUIDE available at www.cintec.com

WARRANTY

Cintec warrants that for a period of 12 months from the date it sells a product it will, as its sole option and discretion, refund the purchase price, or replace such product if it contains a defect in material or workmanship. Absence of Cintec receipt of notification of any such a defect together with a copy of the original invoice within this 12-month period shall constitute a waiver of all claims with regard to such product.

THE FOREGOING WARRANTY IS IN LIEU OF ALL OTHER WARRANTIES, EXPRESS OR IMPLIED, INCLUDING BUT NOT LIMITED TO THE IMPLIED WARRANTIES OF MERCHANTABILITY AND FITNESS FOR A PARTICULAR PURPOSE.

Acceptance of order: Acceptance is limited to the express terms contained herein, and terms are subject to change by Cintec without notice. Additional or different terms proposed by customer are deemed material and are objected to and rejected, but such rejection shall not operate as a rejection of the offer unless it contains variances in the terms of the description, quantity, price or delivery schedule of the goods.

Indemnification: Cintec shall in no event be liable for, and customer hereby agrees to indemnify Cintec against all claims related to, special, direct, indirect, incidental, consequential, or any other damages arising out of or related to the sale, use, or inability to use the product by an approved contractor and or installer for the said project the product was designed for. Customer hereby agrees to indemnify Cintec for any costs, including attorney's fees, incurred by Cintec as a result, in whole or in part, of any violation by customer of any Federal, Provincial or local statute or regulation, or of any nationally accepted standard. It shall be customer's sole responsibility to comply with all applicable laws and regulations regarding the handling, use, transportation, or disposal of products upon taking possession of same.

Cintec's anchoring and reinforcement systems can only be **INSTALLED BY CINTEC TRAINED AND CERTIFIED** installers.

For more information see ENGINEERS GUIDE available at www.cintec.com



TYPICAL ANCHOR DESIGN & TERMINOLOGY

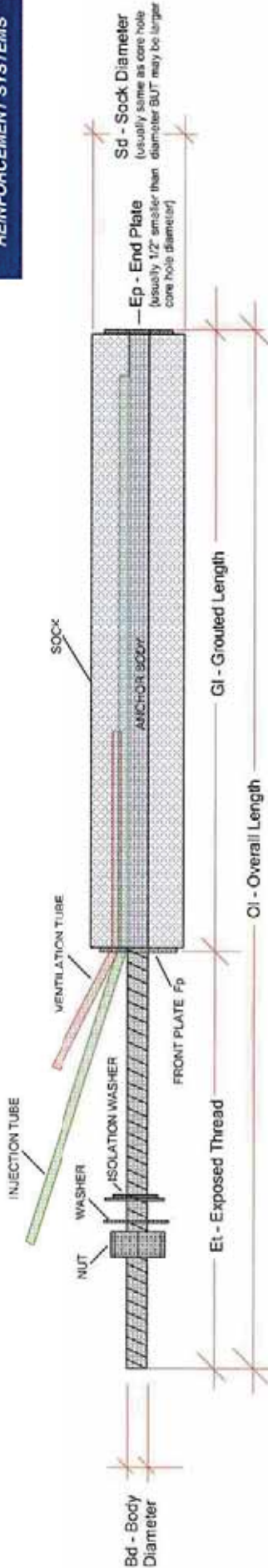

ACCESSORIES

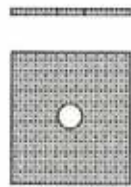

Plate



Adjustable Angled Plate w/ Drop Pin



Brick Tie



Coupling Nut

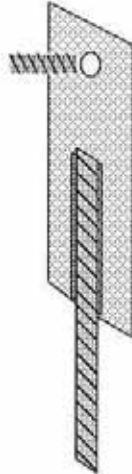

Drop Pin Plate - adjustable when used with coupling nut.

CINTEC TERMINOLOGY

Accessory - end treatment that can be attached to an anchor

Anchor Body - the steel part of the anchor. Usually stainless steel and may be hollow, solid round, square, or other configuration.

Nut - hexagonal with same ID as body and usually of same material.

Plate (End) - on most anchors. Usually 1/2" smaller diameter than the core/ sock diameter. Has hole in centre the size of body so it can be welded / threaded in place. May also have "port (s)" to accommodate injection / ventilation / other tubes.

Plate (Front) - on some anchors. Usually 1/2" smaller diameter than the core/ sock diameter. Has hole in centre the size of body so it can be welded / threaded in place. May also have "port (s)" to accommodate injection / ventilation / other tubes.

Sock - polyester, woven tube usually size matched to the core hole diameter... but NOT always

Tube (Injection) - tube that is glued in place and used to INJECT the anchor sock. It is the longest tube if two or more tubes are present and identified with a sticker with green writing.

Tube (ventilation) - also called "emergency" allows air in system to escape and can also be used if absolutely necessary to inflate anchor. It is glued in place and is the shortest tube if two or more tubes are present and identified with a sticker with red writing.

Washer - also called flat or fender washer.

Washer (Isolation) - also called bonded washer, used to prevent galvanic action between dissimilar materials

FRONT PLATES (Various)

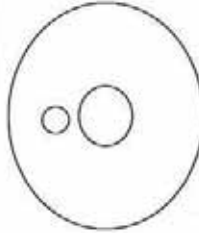

Standard with single port

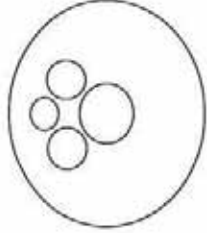

Custom with several ports.

SECTION 2



Reinforcement Systems & Masonry Anchoring



NOTES FOR APPROVED INSTALLERS USING
THE CINTEC REINFORCEMENT &
ANCHORING SYSTEM

ICC - ES Manufacturer's Installation Instructions (MPII)

COPYRIGHT

*This manual is the copyright of Cintec International Limited.
No part shall be reproduced in any media format without the
express permission of Cintec International Limited or its
overseas affiliates.*

THE CINTEC TRAINING COURSE

References to "Cintec" in this document are to the companies Cintec International Ltd (UK), Cintec America Inc., Cintec Canada Ltd or Cintec Australasia Pty Ltd, or to the product manufactured and marketed by those companies, unless contrary to the context.

The object of this training course is to give the installer a complete knowledge of the Cintec Anchoring System.

During the course you will be shown and given hands on experience in the installation techniques used in the Cintec Anchoring System.

Upon completion of the course, successful trainees will be certificated and issue with an identity card. Your company will then be entered onto our list of approved installers.

IDENTITY CARDS



You will be required to carry this identification card on site while undertaking all work requiring the use of the Cintec Anchoring System.

This card must be shown to all authorized site and Cintec personnel upon request. Failure to carry and produce your identity card may terminate your right to remain an approved installer.

As manufacturers, we carry the responsibility of the product thus giving you the responsibility to carry out the work in a workmanlike manner.

This identification card is valid for three years only, after this time period reassessment will be necessary.



Any new employees joining an approved company must receive training from a Cintec representative before they can install the Cintec Anchoring System.

EQUIPMENT REQUIRED FOR THE INSTALLATION OF THE CINTEC ANCHORING SYSTEM

Potable Water
Water Pipe
Electric Power
Extension
Toolbox (screwdriver, pliers, ASS'T wrench, etc.)
Sharp Knife (exacto)
Electrical tape
High Speed Drill (550 RPM minimum)
Air compressor (100 psi) tank capacity 10 gallon
Pressure pot*
Mortar mixing tool*
Injection control valve*
Plastic injection tip*
Sieve / Strainer*
20 liter buckets (2) (clean)*

* Supplied with the injection kit if purchased.



Cintec recommends a pressure pot of at least 10 liters (2.5 US gallons). This can be provided as part of an installation kit for the installation of the Cintec system by Cintec (see Appendix D).

An equivalent pressure pot may be used but it must be able to be pressurized from 200 kPa to 600 kPa. The outlet on the pressure pot needs to be altered to accept a ½" (1.27 cm) BSP hose adapter with 4 metres (12'0") of reinforced ½" (1.27 cm) tubing and a ½" (1.27 cm) quarter turn ball valve. A ½" (1.27 cm) hose adapter or threaded attachment needs to be screwed into the valve to enable plastic mastic nozzles to be pushed or threaded onto the front of the valve. This assembly will then serve as the grout delivery hose and control valve. For large anchors using grout delivery tubes, quick-connect hose fittings may be used. Contact Cintec for details.

All equipment must be kept in a clean condition. Do not use oil or releasing sprays inside the pressure pot as this may contaminate the grout.

Safety goggles and gloves must be worn at all times when mixing and injecting grout.

INSTALLATION

Drilling

Carefully set out the anchor position using a wax crayon or chalk, as per specifications, or as directed by the structural engineer or supervisor.

Select the drilling method specified: -

Wet diamond - dry diamond - rotary percussion - or other

Drill the hole to the required depth of the anchor and the embedment depth required.

Remove all debris and cores from the borehole and check the depth.

Flush out all bore holes with water or compressed air to remove all dust and debris.

Wash off all stains immediately.

Drilling blind into substrates requires special care. Substrates must be checked to ensure that they are as indicated. If not notify the engineer or supervisor. A particular problem is ending the drill hole in a void larger than the anchors expansion capabilities. Careful checks must be made if this is suspected and the engineer or supervisor informed.

Boreholes in loose material must be sleeved immediately after drilling to facilitate anchor insertion and prevent the need for re-drilling.

Grout mixing

The grout is packed in 25 kg (56 Lbs) bags and is mixed with clean cool water.

The normal mixing ratio is 5 litres (1.32 US Gal) of water to one 25 kg (56 Lbs) bag of grout. One 25 kg (56 Lbs) bag will yield 15.5 litres (4.09 US Gal) of fluid grout when mixed.

The 5 litres (1.32 US Gal) of water can be increased by 10% (500ml OR 0.132086 US Gal) in hot weather (20°C +/68°F) and when the substrate is very dry and porous or the injection process is through very small injection tubes.

Do not increase the water content outside of these parameters, as this will considerably weaken the strength of the set grout.

The grout must be mixed as follows:

Place 4½ litres (1.18877 US Gal) of clean/cold water into a clean mixing bucket and slowly add approx. ¾ of one bag of Presstec grout while mixing.

Add the final ½ litre (0.11351 US Gal) of water and the remaining ¼ bag of grout.

Continually mix the grout for 4 minutes removing all the dry mixture from the sides of the bucket.

Allow the mixture to stand for 5 minutes, during which the mixture will start to thicken, the amount the mixture thickens will depend on the ambient temperature and the temperature of the dry grout and water.

At this stage some or all of the 10% extra water may be added to achieve a smooth creamy texture with no peaks forming on the surface.

HOW TO MIX

See also hot weather and cold weather procedures

4½ LITRES (1.135104 US Gal) OF WATER
=



Very clean bucket or container

+ 1/2 LITRE (0.11351 US Gal) OF WATER



Graduated plastic pitcher

25 KG (56 Lbs) BAG

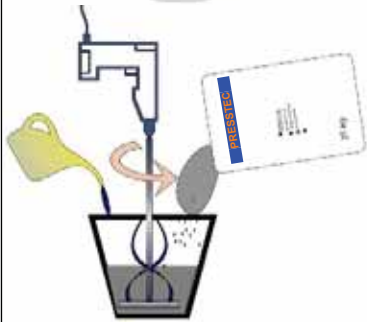

Electric mixer capable of 500 rpm



4 minutes of continuous mixing.



Allow to stand for 5 minutes



Re-mix and add up to 10% (550ml or 0.124861 US Gal) of water if required.

Installation then proceeds:

Pour the mixed grout into the pressure pot through the sieve.

Pressurize the pot from 300 kPa to 500 kPa (40-72 psi) dependent on the type and length of anchor being installed.

Cut the plastic mastic nozzle to fit the anchor's orifice. On anchors with injection tubes, prime the tube with water and cut the mastic nozzle to fit over the injection tube.

Test the grout flow into a suitable bucket. If the grout flow is continuous and of sufficient pressure the anchor can be injected.

Grout is introduced into pressure pot through a sieve

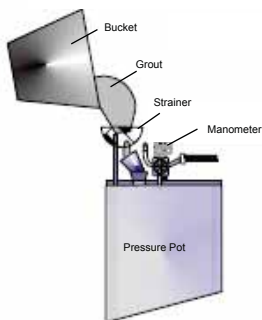

Injection pipe no longer than 12 feet / 4 meters.

Any reasonable distance

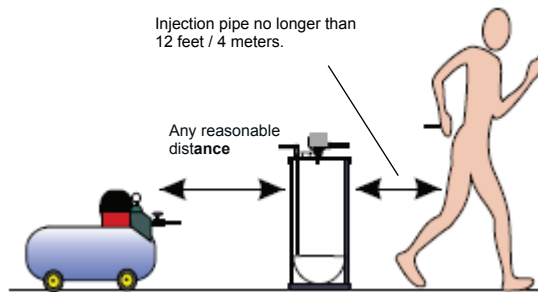

Compressor with a minimum of 2.6 cu. ft. and 90 PSI.

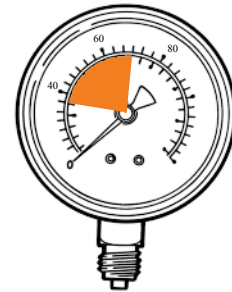

Injection limits between 300 & 500 kPa (40-72 psi)



Hand held grouting gun for small quantities



Center the anchor body in the hole.

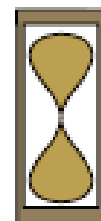

Pot life 60 minutes dependent on temperature

ANCHOR INSERTION

Carefully unpack the anchor and check there has been no damage to the fabric sock during transit.

All damages must be reported to Cintec.

Small tears or rips in the sock can be repaired using a needle and strong cotton and/or a hot-melt glue stick.

Do not shorten the length of the sock on the anchor.

At this stage the anchor must be handled with extreme care and should not be unwrapped until required.

Some long anchors require sleeves to protect the anchor during insertion, wherever possible use sleeves.

Immediately prior to insertion wet the anchor completely with clean water and position the sock evenly along the length of the anchor.

Long anchors should be wet after insertion into the borehole

N.B. Do not allow the sock to remain completely saturated with water for a long period as this may cause the fabric sock to shrink.

Place the anchor in the bore hole and carefully push the anchor in, lifting it over any fissures or voids, do not force or twist the anchor into the hole.

Install the anchor to within 50 mm (2") of the face of the brickwork (do not push completely in yet.)

ANCHOR INSTALLATION

Carefully cut the nozzle to fit over the injection tube and position the anchor to the specified depth (minimum 25 mm or 1" beyond face of brickwork).

Prior to the mixing and injection of the grout, the equipment should be primed and checked with clean water to ensure that the injection equipment is working and that there are no blockages.

Turn on the control valve and the grout will flow to the rear of the anchor and inflate the sock along the length of the anchor to the front.

Rotate the anchor slowly and carefully if necessary, in a circular motion to facilitate the grout flow and to ensure the anchor is centred in the borehole upon completion.

At this stage the anchor will be felt to be locking in the borehole and grout milk will appear at the front of the anchor (note the colour change in the sock).

Maintain the pressure until the grout milk has stopped flowing and the sock at the front of the anchor cannot be easily compressed.

Use a sponge or cloth during this process to soak up the excess grout milk and avoid the milk running down the face of the brickwork/stonework.

The grout, anchors and pressure pot must be stored in a container or room with a temperature of no less than 10°C (50°F).

The clean water used for mixing must be within the temperature range of 15°C - 20°C (59°F-68°F).

ANCHOR INSTALLATION

SHORT ANCHORS

Pre wet short anchors
before installation

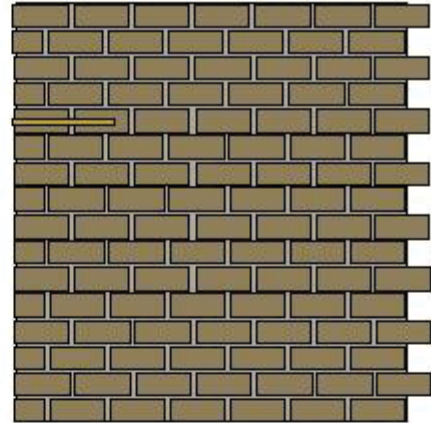

LONG ANCHORS

Pre wet long anchors
after insertion

Ensure sock is evenly distributed along the full length of the anchor as the anchor is installed. Do not twist or force the anchor as it is pushed into the drilled hole.

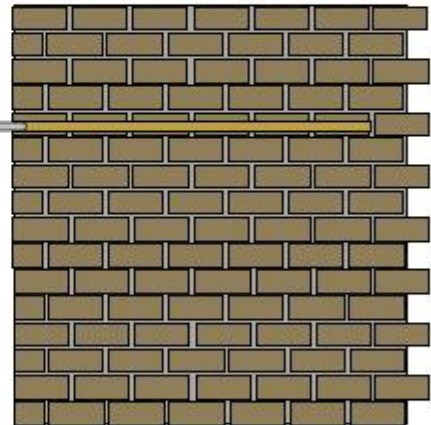

Prime any injection tubes with clean water prior to injection.

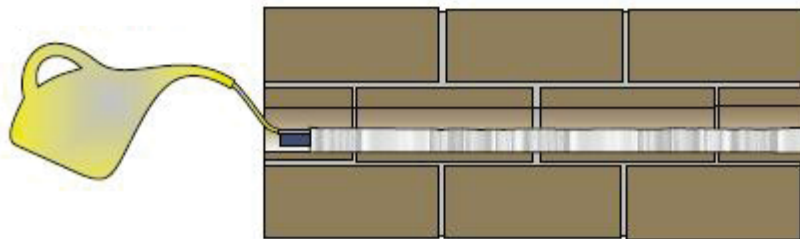

Any grout or milk on the wall must be washed off immediately. Please note that the anchor is not fully inflated until the grout milk has stopped flowing through the sock. Pressure must be maintained to allow this to be achieved.

With large injection orifices, a suitable plug must be placed in the injection port immediately after removing the nozzle.

STUDDING AND SOLID BAR (REBAR) ANCHORS, THE NORMAL INSTALLATION STILL APPLIES, BUT THE FOLLOWING METHOD NEEDS TO BE ADOPTED TO FACILITATE THE INSTALLATION.

When inserting the anchor, ensure that the injection tube is towards the top of the borehole – NEVER force or twist the anchor into the hole.

COLD WEATHER GROUTING

The installer shall ensure that the minimum temperature of the grout at the time of injection is 7°C (44.6°F) and the temperature of the injected grout does not fall below 5°C (41°F) for a period of twenty-four hours from the beginning of inflation.

Core holes must be at a minimum of 5°C (41°F) prior to anchor installation and maintained above a 5°C (41°F) for at least 24 hours after installation. If this is impracticable, cold weather procedures must be adopted with the consent of Cintec.

The cold weather procedures are as follows:

- The pressure pot and delivery hose should be lagged with a suitable insulating material.
- The grout, anchors and pressure pot must be stored in a container or room with a temperature of no less than 10°C (50°F).
- The clean water used for mixing must be within the temperature range of 15°C - 20°C (59°F-68°F).
- The bore hole temperature must not be below 5°C (41°F) and no ice must be present on the surface of the borehole.
- A suitable shelter needs to be used for the mixing process.
- A screen needs to be erected around the installation area to avoid any wind chill.
- After drilling the borehole, install a suitable plug to maintain a constant core temperature.
- Insert the anchor in the borehole just prior to inflation (as per normal installation methods).
- Mix the grout as per instructions using the heated water and sieve into the insulated pot.
- The pressure pot and delivery hose should be lagged with a suitable insulation material.
- Inflate the anchor as normal.
- Immediately after inflation, install insulation in the front of the borehole.

COLD WEATHER
 Allow the outside temperature to rise before injecting the grout, i.e. do not inflate first thing in the morning or last thing in the afternoon.
 Please note that these procedures must be carried out with extreme care and should not be used unless a representative from Cintec is present.

Shelter prefabricated from scaffolding and polythene sheets to mixing area and anchor installation area to form a wind break.

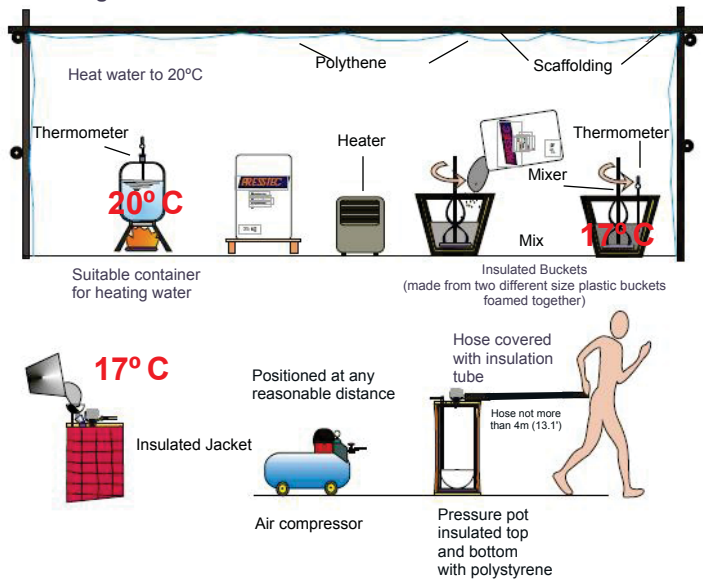

The temperature of the grout during the injection must never be lower than 8 ° C.

Bore hole temperature must be a minimum 5°C (41°F)

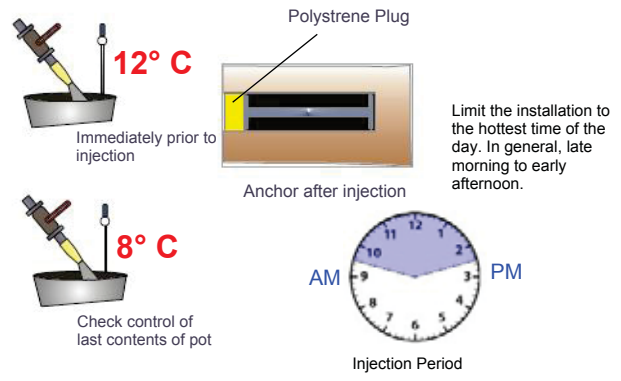

Grout Mix Report

Date: _____
 Batch number: _____
 Water temperature: _____
 Final mixing temperature: _____
 Temperature prior to injection: _____
 Final pot batch temperature: _____

HOT WEATHER GROUTING

In very hot climates the maximum temperature of the grout at time of injection must not exceed 20°C(68°F). If the temperature exceeds this, the clean water used for mixing must be cooled to 15°C (59°F).

The pressure pot and the bore hole must be shielded from direct sunlight. In extreme conditions the pressure pot must be placed in a vat of cooled water or ice.

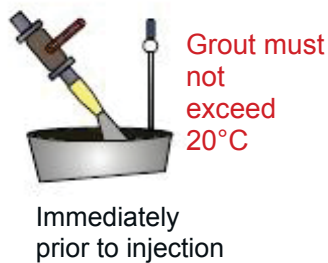
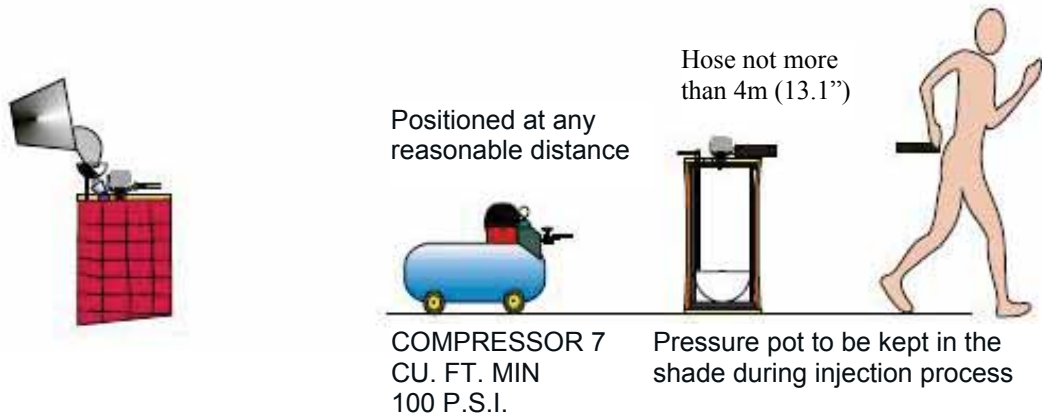
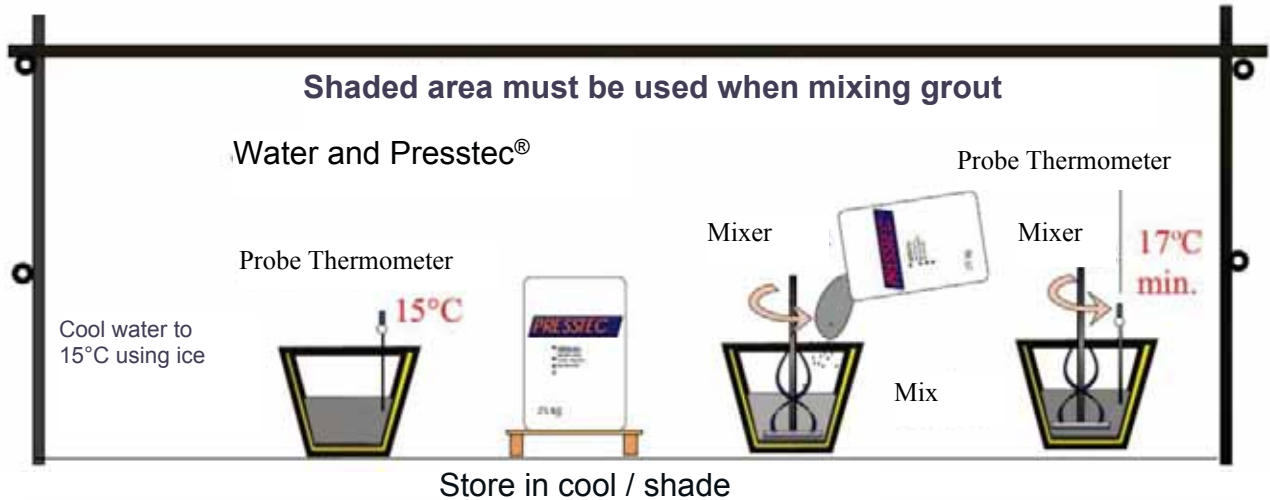

PROBLEMS ENCOUNTERED DURING INSTALLATION

Grout blockage can occur in the hose and control valve if left in direct sunlight or the mixed grout has not been sieved correctly.

The anchor will not inflate if the sock has been ripped during installation. Remove the anchor from the borehole and check the sock, small tears can be repaired and the anchor reinstalled; if the damage is more severe remove the grout and fabric sock and wash off the anchor completely. Notify Cintec who will arrange a repair procedure.

Anchor fails to fill, only partially fills, fails to reach surface of borehole.

There are a number of factors to consider here, check all the following possibilities:

- Grout mixture too thick either by incorrect mixing or outside the working time of the mixed grout (usually between 45 minutes and 1 hour, dependent on conditions.)
- Grout has passed its shelf life. Check date on side of bag.
- Anchor installed in a borehole of larger diameter than that for which it was designed. Check original order.
- Large voids are present tensioning the sock at the front of the anchor. A larger sock may be required.
- Insufficient pressure in the pot. Shut off the air from the compressor and check that the pressure pot is maintaining a constant pressure. If it is dropping, check for leaks. Remember, what is shown on the gauge is not necessarily what is in the pot because the air can be passing into the pot and straight out through any leaks.
- The sock has twisted during installation, preventing the grout passing the twist. Do not force or twist the anchor while inserting.
- Sock not distributed evenly before insertion, therefore there is too much sock at the front of the borehole preventing complete inflation.
- Failure to wet the sock. This is very important in porous substrates and in dry/hot weather conditions.

IMPORTANT POINTS TO CONSIDER BEFORE ORDERING ANCHORS

The anchor system is engineered for the specific installation, therefore as much information as possible about the type of substrate and possible voids etc. is required to enable us to manufacture the exact anchor to meet your requirements.

The minimum embedment depth of any anchor is 75 mm (3") unless test anchors have been installed to determine the load achievable with a reduced embedment.

The max length of an 8 mm (5/16") or 10 mm (3/8") CHS (circular hollow section) anchor in a 20 mm (3/4") hole is 500mm (20").

For lengths between 500 mm (20") and 1000 mm (39"), a 24 mm (1") hole is required for a 10 mm (3/8") CHS.

The general rule is that the borehole must be twice the diameter of the anchor body utilized. This is only applicable up to certain lengths and the hole size must be increased on longer anchors.

The guidelines are as follows:

8mm (5/16") CHS	20mm (3/4") borehole up to 500mm (20")
10mm (3/8") CHS	20mm (3/4") borehole up to 500mm (20")
10mm (3/8") CHS	25mm (1") borehole up to 1000mm (39")
10mm (3/8") CHS	32mm (1 1/4") borehole up to 2000mm (6'6")
15mm (5/8") x 15mm (5/8") SHS	32mm (1 1/4") borehole up to 3000mm (9'9")
20mm (3/4") x 20mm (3/4") SHS	40mm (1 1/2") borehole up to 3000mm (9'9")
30mm (1 3/16") x 30mm (1 3/16") SHS	60mm (2 1/2") borehole up to 4000mm (13'0")
M10 (3/8") studding	32mm (1 1/4") borehole up to 1000mm (39")
M12 (1/2") studding	32mm (1 1/4") borehole up to 1000mm (39")
M16 (5/8") studding	40mm (1 1/2") borehole up to 3000mm (9'9")
M20 (3/4") studding	50mm (2") borehole up to 4000mm (13'0")

CARE OF ANCHORS AND GROUT

The anchors and fixings are supplied with the correct amount of grout. Care must be taken not to waste grout. The anchors, fixings and grout should be stored safely away from all work areas until needed.

GROUT

Store grout in a dry place off the ground. NEVER allow the grout to become damp, or wet, or store in a place where the temperature can drop below 5°C (41°F).

NB – The marriage of steel and fabric is very delicate and the anchors must be treated accordingly to ensure that no damage to the fabric sock occurs. DO NOT leave anchors lying around on the ground or on scaffolding. NEVER use anchors to test the hole depth.

NOTES AND METHOD STATEMENT FOR GROUT FILLED CARTRIDGES

1. Use small clean container E.G. plastic paint bucket and measuring jug.
2. Remove back plug from container, pour grout contents into the mixing pot, gradually add small amount of clean water stirring until the consistency is a smooth medium thick cream.
3. Mix for at least four minutes with a whisk then allow to stand for a further four minutes and whisk again.
4. Pour the mixed grout back into the container and replace back plug securely.
5. Remove nozzle to remove inner plug and replace nozzle.
6. Place container into master gun, insert nozzle into back of anchor and proceed to pump.
7. Pump until trigger is stiff, hold for 10 seconds, release safety catch and withdraw slowly from the anchor.
8. Repeat the same process for each anchor.

NB – If you use a re-usable mastic/grout gun. These hold approximately ½ litre (0.11351 US Gal) of grout. Therefore 220 ml (0.058118 US Gal) of water to 1 kg (2.2 lbs) of grout is enough for one fill, which will pump 5 RAC standard anchors. The water ratio can be altered slightly dependent on weather conditions. Mix as above for at least four minutes, allow to stand for four minutes, mix for a further minute.

Stages

- | | |
|--------|--|
| Step 1 | Measure 220 ml (0.06 US Gal) of water into a clean container and slowly add 1 kg (2.2 lbs) of grout, whisk thoroughly for four minutes and allow to stand for a further four minutes and whisk again. The mixture should be smooth and creamy with no lumps. |
| Step 2 | Pour mixed grout into front of gun and replace tap assembly. |
| Step 3 | Turn off tap and pressurize gun. |
| Step 4 | Push nozzle on anchor and open valve. When anchor is full, keep pressure on for 10 seconds, close valve and remove nozzle. |

If you use a metal grout gun, grout on occasions collects at the base. To overcome this problem, do not fully empty the gun, and remove excess grout. Swill all parts in a clean bucket of water between each mix.

NB – Metal hand grout guns must be washed and fully cleaned and thoroughly dried, after use. DO NOT oil cylinder as this would contaminate the grout.

Failure to carry out above will result in rusty equipment.

CONSTRUCTION SITE SAFETY CHECK LIST

The information that follows is derived from Cintec experience worldwide. It is supplied in good faith, but is not intended to be used in place of any statutory requirements. Occupational Health and Safety regulations that apply in the area in which the installation is being carried out must be adhered to at all times.

Safe access

- Can everyone reach their place of work safely, i.e. are there good roads, gangways, passage ways passenger hoists, staircases, ladders and scaffolds?
- Are all walkways level and free from obstructions such as stored material and wastes?
- Are there adequate barriers or other edge protection to stop falls from open edges of buildings, gangways etc.?
- Are holes and openings securely fenced off or provided with covers?
- Is there adequate artificial lighting when work is carried out after dark or inside buildings?
- Is the site tidy and are materials stored safely?
- Are there proper arrangements for collecting and disposing of scrap?
- Have nails in timber been hammered down or removed?

Ladders

- Are ladders the right equipment to use for the job or should a scaffold be provided?
- Are all ladders in good condition?
- Are ladders secured near the top (even if they will be used for only a short time)?
- If ladders cannot be secured at the top, are they secured near the bottom, weighted or footed to prevent slipping?
- Do the ladders rise the required minimum distance above their landing places or the highest rungs used (refer to appropriate regulations)? If not, are there adequate handholds?
- Are the ladders properly positioned for access?

Tubular scaffolds

- Is there proper access to the scaffold platform?
- Are all uprights provided with base plates (and, where necessary, timber sole plates) or prevented in some way or other from slipping or sinking?
- Have any uprights, ledges, braces or struts been removed?
- Is the scaffold secured to the building in enough places to prevent collapse?
- If any ties have been removed since the scaffold was erected have additional ties been provided to replace them?
- Are the working platforms fully covered?
- Are boards free from obvious defects such as knots and are they arranged to avoid tipping or tripping?
- Are there effective barriers or warning notices to stop people using an incomplete scaffold e.g. one that isn't fully boarded?
- Where the scaffold has been designed and constructed for loading with materials, are these evenly distributed?
- Does a competent person inspect the scaffold regularly i.e. at least once a week and always after bad weather?
- Are the results of inspection recorded (including any defects that were put right during the inspections) and the records signed by the person who carried out the inspections?
- Is there safe access to the excavation e.g. a sufficiently long ladder? Are there barriers to stop people falling in? Is the excavation affecting the stability of neighbouring buildings? Are stacked materials, spoil or plant stored near the edge of the excavation likely to cause a collapse to the site? If vehicles tip into the excavation, are properly secured stop blocks provided?

Machinery

- Are there any dangerous parts e.g. exposed gears, chain drives, projecting engine shafts?
- Are the dangerous parts adequately guarded?
- Are guards secured and in good repair?

Electricity

- Are all portable electric tools and equipment run from a power supply with earth leakage circuit breaker protection?
- Can you see any signs of damage or interference with equipment, wires and cables? Where required, have power tools been checked and tagged by a licensed electrician?
- Are all connections to power points made by proper plugs?
- Are connections to plugs properly made so that the cable grip holds the cable firmly and prevents the earth wire from being pulled out?
- Are there any overhead power lines? Where anything might touch the lines or cause arcing (cranes, tipper lorries, scaffolding etc.), has the electricity supply been turned off or other precautions taken to prevent such contact with the lines?
- Have underground electricity cables been located (with a cable locator and cable plans), marked and precautions taken to avoid contact with them?

Noise

- Are breakers fitted with muffs?
- Is other plant or machinery fitted with silencers?
- Do workers wear ear protection if they have to work in very noisy surroundings?

Protective Clothing

- Is equipment provided to protect the head, nose, eyes, hands and feet?
- Does the equipment meet at least the minimum standard required by law?
- Do workers wear their protective equipment?

Welfare

- Has a suitable toilet been provided?
- Is there a clean washbasin, soap and towel?
- Is wet weather gear provided for those who have to work in wet conditions?
- Is there a site hut where workers can sit and make tea?
- Is there a first aid box?

Site Cleaning

Site tidiness is the foundation of safety and of a job well done.

Always keep your immediate surroundings clean and clear of debris and unwanted plant. This must sound obvious, but surprisingly few people adopt this procedure. Just taking a few minutes care by putting away unwanted tools and equipment will give more room, work space and a clean and level base to work from, saving you time in the long run. This means that it is safer for you and your workmates. They do not slip, trip or step on articles that have been dropped. A clean site is a well run site.

PRESSTEC® GROUT HEALTH & SAFETY

Presstec® grout has been assessed in accordance with the classification, packaging and labeling requirements of regulations pertaining to dangerous substances in various countries and Cintec takes the view that it is not a dangerous or hazardous substance. Precautions common to the handling of Portland cement, slaked lime and products containing them are applicable to the handling of Presstec® grout.

The only precaution that needs to be taken when handling Presstec® grout is the common sense one of elementary hygiene. Unnecessarily prolonged contact on the skin, particularly when damp, should be avoided. Gloves should be worn when handling Presstec® grout bags. If Presstec® grout is in contact with skin, it should be washed off as soon as possible. If Presstec® grout enters the eye it should be immediately washed out thoroughly with clean water and medical treatment sought immediately. Eye protection and respiratory protection should be worn when working in dusty conditions.

Presstec® grout powder mixed with water releases alkali. Concrete or mortar adhering to the skin should be removed as soon as possible by washing with soap and water. Delay may cause skin irritation. Waterproofing gloves, eye protection, (safety) gum boots, full length trousers, long sleeved shorts and other suitable protective clothing should be worn when working with mortar.

Material Safety Data Sheets

Appended is the European Community "C.O.S.H.H." sheet is provided as the M.S.D.S in accordance with the format provisions of Section 6 of the Code of Practice for the Preparation of Material Safety Data Sheets.

These notes are for guidance only. If you have any queries on the Cintec Anchoring System please contact us at the address below.

CINTEC International Limited
Cintec House, 11 Gold Tops,
Newport, South Wales, NP20 4PH,
Tel: 044 (0) 1633 246614
Fax: 044 (0) 1633 246110

Cintec America Inc
200 International Circle, Suite 5100
Hunt Valley, Maryland, 21030
Tel: 1 410-761-0765
Fax: 613-224-9042

Cintec Canada Limited
38 Auriga Drive, Suite 2
Nepean, ON K2E 8A5
Tel: 613-225-3381
Fax: 613-224-9042

Appendix B

CINTEC PRODUCT INFORMATION UPDATE

NO 1/99: ALTERATIONS OF ANCHORS

We have recently experienced a number of instances where the anchors have been physically altered on site without our knowledge or approval. This is an extremely dangerous practice and apart from breaching the conditions of warranty, there is a possibility that the anchors would not meet their performance specifications. We fully understand that, periodically, problems will occur on site, but we ask that you contact us on such occasions so that checks can be made to ensure the anchors perform to the required specifications and the new dimensions can be entered into our records.

NO 1/02: PRESSTEC® GROUT – HEALTH & SAFETY AT WORK

While working on site, an operative was injecting an anchor with Presstec® grout and some of the grout splashed into his eye. The eye was damaged and the operative underwent surgery. He was not wearing protective goggles.

It is essential that personnel wear goggles while mixing or working with Presstec Grout®. This requirement is specified in the COSHH Statement, is emphasised during training carried out by Cintec staff and is clearly laid down in the Training Manual.

Presstec 2000 and Presstec Standard

Safety Data Sheet

according to Federal Register / Vol. 77, No. 58 / Monday, March 26, 2012 / Rules and Regulations

Revision Date: 02/11/2014 Version: 1.0

02/11/2014 EN (English US) 1/7



Version: 1.0

SECTION 1: IDENTIFICATION OF THE SUBSTANCE/MIXTURE AND OF THE COMPANY

1.1. Product Identifier

Product Form: Mixture**Product Name:** Presstec 2000 and Presstec Standard

1.2. Intended Use of the Product

Use of the Substance/Mixture: Building Material

1.3. Name, Address, and Telephone of the Responsible Party

Company

Cintec Reinforcement Systems

T 1-613-225-3381 - T - 1-410-761-0765 - F 613-224-9042

solutions@cintec.com

1.4. Emergency Telephone Number

Emergency Number : Company: 1-613-225-3381 (8:30-16:30 EST)

Information centre specializing in Symptoms of Poisoning Telephone: 1-800-222-1222

SECTION 2: HAZARDS IDENTIFICATION

2.1. Classification of the Substance or Mixture

Classification (GHS-US)

Skin Irrit. 2 H315

Eye Dam. 1 H318

Skin Sens. 1 H317

Carc. 1A H350

STOT SE 3 H335

STOT RE 1 H372

2.2. Label Elements

GHS-US Labeling

Hazard Pictograms (GHS-US) :



GHS05



GHS07



GHS08

Signal Word (GHS-US)

: Danger

Hazard Statements (GHS-US)

: H315 - Causes skin irritation
 H317 - May cause an allergic skin reaction
 H318 - Causes serious eye damage
 H335 - May cause respiratory irritation
 H350 - May cause cancer
 H372 - Causes damage to organs through prolonged or repeated exposure

Precautionary Statements (GHS-US) :

P201 - Obtain special instructions before use.
 P202 - Do not handle until all safety precautions have been read and understood.
 P260 - Do not breathe dust.
 P264 - Wash hands, forearms, and other exposed areas thoroughly after handling.
 P270 - Do not eat, drink or smoke when using this product.
 P271 - Use only outdoors or in a well-ventilated area.
 P272 - Contaminated work clothing should not be allowed out of the workplace.
 P280 - Wear protective gloves, protective clothing, eye protection, face protection, respiratory protection.
 P302+P352 - IF ON SKIN: Wash with plenty of soap and water.
 P304+P340 - IF INHALED: Remove victim to fresh air and keep at rest in a position comfortable for breathing.
 P305+P351+P338 - If in eyes: Rinse cautiously with water for several minutes. Remove contact lenses, if present and easy to do. Continue rinsing.

Presstec 2000 and Presstec Standard

Safety Data Sheet

according to Federal Register / Vol. 77, No. 58 / Monday, March 26, 2012 / Rules and Regulations



P308+P313 - If exposed or concerned: Get medical advice/attention.
 P310 - Immediately call a POISON CENTER or doctor/physician.
 P312 - Call a POISON CENTER/doctor/physician if you feel unwell.
 P314 - Get medical advice and attention if you feel unwell.
 P321 - Specific treatment (see section 4).
 P332+P313 - If skin irritation occurs: Get medical advice/attention.
 P333+P313 - If skin irritation or rash occurs: Get medical advice/attention.
 P362 - Take off contaminated clothing and wash before reuse.
 P362+P364 - Take off contaminated clothing and wash it before reuse.
 P403+P233 - Store in a well-ventilated place. Keep container tightly closed.
 P405 - Store locked up.
 P501 - Dispose of contents/container to local, regional, national, and international regulations.

2.3. Other Hazards

Other Hazards Not Contributing to the Classification: Exposure may aggravate those with pre-existing eye, skin, or respiratory conditions. Repeated or prolonged exposure to respirable (airborne) crystalline silica dust will cause lung damage in the form of silicosis. Symptoms will include progressively more difficult breathing, cough, fever, and weight loss. Product becomes alkaline when exposed to moisture or water. Exposure can cause chemical burns, or severe irritation of the mucous membranes, skin, eyes, and other exposed areas.

2.4. Unknown Acute Toxicity (GHS-US)

No data available

SECTION 3: COMPOSITION/INFORMATION ON INGREDIENTS

3.1. Substance

Not applicable

Full text of H-phrases: see section 16

3.2. Mixture

Name	Product identifier	%	Classification (GHS-US)
Cement, portland, chemicals	(CAS No) 65997-15-1	58	Skin Irrit. 2, H315 Eye Dam. 1, H318 Skin Sens. 1, H317 STOT SE 3, H335
Quartz	(CAS No) 14808-60-7	41	Carc. 1A, H350 STOT SE 3, H335 STOT RE 1, H372
Limestone	(CAS No) 1317-65-3	41	Not classified
Proprietary Additive	Proprietary	<1.0	Not classified

The specific chemical identity and/or exact percentage of composition has been withheld as a trade secret.

Full text of H-phrases: see section 16

4.1. Description of First Aid Measures

First-aid Measures General: Never give anything by mouth to an unconscious person. If you feel unwell, seek medical advice (show the label where possible).

First-aid Measures After Inhalation: When symptoms occur: go into open air and ventilate suspected area. If exposed or concerned: Get medical advice/attention. Remove to fresh air and keep at rest in a position comfortable for breathing.

First-aid Measures After Skin Contact: Remove contaminated clothing. Drench affected area with water for at least 15 minutes. Brush off loose particles from skin. Wash contaminated clothing before reuse. If skin irritation occurs: Get medical advice/attention.

First-aid Measures After Eye Contact: Rinse cautiously with water for several minutes. Remove contact lenses, if present and easy to do. Continue rinsing. Immediately call a POISON CENTER or doctor/physician.

First-aid Measures After Ingestion: Rinse mouth. Do NOT induce vomiting. Seek medical attention immediately.

4.2. Most important symptoms and effects, both acute and delayed

Symptoms/Injuries: Causes damage to organs through prolonged or repeated exposure. Causes serious eye damage. Skin irritation. May cause cancer. May cause respiratory irritation. Product becomes alkaline when exposed to moisture or water. Exposure can cause chemical burns, or severe irritation of the mucous membranes, skin, eyes, and other exposed areas.

Presstec 2000 and Presstec Standard

Safety Data Sheet

according to Federal Register / Vol. 77, No. 58 / Monday, March 26, 2012 / Rules and Regulations



Symptoms/Injuries After Inhalation: May cause cancer by inhalation. May cause respiratory irritation.

Symptoms/Injuries After Skin Contact: Causes skin irritation. May cause an allergic skin reaction.

Symptoms/Injuries After Eye Contact: Causes serious eye damage.

Symptoms/Injuries After Ingestion: Ingestion is likely to be harmful or have adverse effects.

Chronic Symptoms: May cause cancer. Causes damage to organs through prolonged or repeated exposure. Repeated or prolonged exposure to respirable (airborne) crystalline silica dust will cause lung damage in the form of silicosis. Symptoms will include progressively more difficult breathing, cough, fever, and weight loss.

4.3. Indication of Any Immediate Medical Attention and Special Treatment Needed

If exposed or concerned, get medical advice and attention.

SECTION 5: FIREFIGHTING MEASURES

5.1. Extinguishing Media

Suitable Extinguishing Media: Use extinguishing media appropriate for surrounding fire.

Unsuitable Extinguishing Media: Do not use a heavy water stream. Use of heavy stream of water may spread fire.

5.2. Special Hazards Arising From the Substance or Mixture

Fire Hazard: Not considered flammable but may burn at high temperatures.

Explosion Hazard: Product is not explosive.

Reactivity: Hazardous reactions will not occur under normal conditions. Wet portland cement is alkaline. As such it is incompatible with acids, ammonium salts and phosphorus.

5.3. Advice for Firefighters

Precautionary Measures Fire: Exercise caution when fighting any chemical fire.

Firefighting Instructions: Use water spray or fog for cooling exposed containers.

Protection During Firefighting: Do not enter fire area without proper protective equipment, including respiratory protection.

Other information: Do not allow run-off from fire fighting to enter drains or water courses.

SECTION 6: ACCIDENTAL RELEASE MEASURES

6.1. Personal Precautions, Protective Equipment and Emergency Procedures

General Measures: Avoid all contact with skin, eyes, or clothing. Do not breathe dust. Avoid generating dust.

6.1.1. For Non-emergency Personnel

Protective Equipment: Use appropriate personal protection equipment (PPE).

Emergency Procedures: Evacuate unnecessary personnel.

6.1.2. For Emergency Responders

Protective Equipment: Equip cleanup crew with proper protection.

Emergency Procedures: Ventilate area.

6.2. Environmental Precautions

Prevent entry to sewers and public waters.

6.3. Methods and Material for Containment and Cleaning Up

For Containment: Avoid generation of dust during clean-up of spills. Let the product solidify.

Methods for Cleaning Up: Clear up spills immediately and dispose of waste safely. Avoid generation of dust during clean-up of spills. Take up mechanically (sweeping, shovelling) and collect in suitable container for disposal.

6.4. Reference to Other Sections

See heading 8, Exposure Controls and Personal Protection.

SECTION 7: HANDLING AND STORAGE

7.1. Precautions for Safe Handling

Additional Hazards When Processed: Product becomes alkaline when exposed to moisture or water. Exposure can cause chemical burns, or severe irritation of the mucous membranes, skin, eyes, and other exposed areas. When heated to decomposition, emits toxic fumes.

Precautions for Safe Handling: Obtain special instructions before use. Do not handle until all safety precautions have been read and understood. Use only outdoors or in a well-ventilated area. Do not breathe dust.

Hygiene Measures: Handle in accordance with good industrial hygiene and safety procedures. Wash hands and other exposed areas with mild soap and water before eating, drinking, or smoking and again when leaving work. Do not eat, drink or smoke when using this product. Wash hands and forearms thoroughly after handling. Contaminated work clothing should not be allowed out of the workplace. Wash contaminated clothing before reuse.

7.2. Conditions for Safe Storage, Including Any Incompatibilities

Technical Measures: Comply with applicable regulations. Avoid creating or spreading dust.

Presstec 2000 and Presstec Standard

Safety Data Sheet

according to Federal Register / Vol. 77, No. 58 / Monday, March 26, 2012 / Rules and Regulations



Storage Conditions: Keep/Store away from extremely high or low temperatures, water, incompatible materials. Store in a wellventilated place. Keep container tightly closed.

Incompatible Products: Strong acids. Strong bases. Strong oxidizers. Aluminum. Ammonium salts.

7.3. Specific End Use(s)

Building Material.

SECTION 8: EXPOSURE CONTROLS/PERSONAL PROTECTION

8.1. Control Parameters

Quartz (14808-60-7)		
USA ACGIH	ACGIH TWA (mg/m ³)	0.025 mg/m ³
USA NIOSH	NIOSH REL (TWA) (mg/m ³)	0.05 mg/m ³
USA IDLH	US IDLH (mg/m ³)	50 mg/m ³
Cement, portland, chemicals (65997-15-1)		
USA ACGIH	ACGIH TWA (mg/m ³)	1 mg/m ³
USA NIOSH	NIOSH REL (TWA) (mg/m ³)	5 mg/m ³
USA IDLH	US IDLH (mg/m ³)	5000 mg/m ³
USA OSHA	OSHA PEL (TWA) (mg/m ³)	5 mg/m ³
Limestone (1317-65-3)		
USA NIOSH	NIOSH REL (TWA) (mg/m ³)	5 mg/m ³
USA OSHA	OSHA PEL (TWA) (mg/m ³)	5 mg/m ³

8.2. Exposure Controls

Appropriate Engineering Controls

: Emergency eye wash fountains should be available in the immediate vicinity of any potential exposure. Ensure adequate ventilation, especially in confined areas. Avoid dust production. Ensure all national/local regulations are observed.

Personal Protective Equipment

: Protective clothing. Protective goggles. Gloves. Wear respiratory protection.



Materials for Protective Clothing

: Chemically resistant materials and fabrics.

Hand Protection

: Wear chemically resistant protective gloves.

Eye Protection

: Wear ANSI approved glasses or safety goggles and skin protection.

Skin and Body Protection

: Wear gloves, boot covers and protective clothing impervious to water to prevent skin contact. Do not rely on barrier creams, in place of impervious gloves. Remove clothing and protective equipment that becomes saturate with wet cement and immediately was exposed areas.

Respiratory Protection

: Under ordinary conditions no respiratory protection is required. Wear a NIOSH approved respirator that is properly fitted and in good condition when exposed to dust above exposure limits.

Other Information

: When using, do not eat, drink or smoke.

SECTION 9: PHYSICAL AND CHEMICAL PROPERTIES

9.1. Information on Basic Physical and Chemical Properties

Physical State	: Solid (Powder)
Appearance	: Grey/White powder
Odor	: None
Odor Threshold	: No data available
PH	: 11 - 13.5 (1% aqueous solution)
Relative Evaporation Rate (butylacetate=1)	: No data available
Melting Point	: 1250°C (2282°F)
Freezing Point	: Not applicable
Boiling Point	: No data available
Flash Point	: No data available
Auto-ignition Temperature	: No data available

Presstec 2000 and Presstec Standard

Safety Data Sheet

according to Federal Register / Vol. 77, No. 58 / Monday, March 26, 2012 / Rules and Regulations



Decomposition Temperature	: No data available
Flammability (solid, gas)	: No data available
Vapor Pressure	: No data available
Relative Vapor Density at 20 °C	: No data available
Relative Density	: No data available
Specific Gravity	: 900-1500 g/mL
Solubility	: 3g/L (@20°C (68°F)).
Log Pow	: No data available
Log Kow	: No data available
Viscosity	: No data available
Explosive Limits	: Not applicable

9.2. Other Information No additional information available

SECTION 10: STABILITY AND REACTIVITY

10.1 Reactivity: Hazardous reactions will not occur under normal conditions. Wet portland cement is alkaline. As such it is incompatible with acids, ammonium salts and phosphorus.

10.2 Chemical Stability: Stable at standard temperature and pressure.

10.3 Possibility of Hazardous Reactions: Hazardous polymerization will not occur.

10.4 Conditions to Avoid: Extremely high or low temperatures. Incompatible materials. Water. Humidity.

10.5 Incompatible Materials: Strong acids. Strong bases. Strong oxidizers. Aluminum. ammonium salts.

10.6 Hazardous Decomposition Products: Carbon oxides (CO, CO₂). Quartz (silica) will dissolve in hydrofluoric acid producing a corrosive gas, silicon tetrafluoride. Toxic gases. Oxides of calcium.

SECTION 11: TOXICOLOGICAL INFORMATION

11.1. Information On Toxicological Effects

Acute Toxicity: Not classified

Quartz (14808-60-7)	
LD50 Oral Rat	> 5000 mg/kg

Skin Corrosion/Irritation: Causes skin irritation. **pH:** 11 - 13.5 (1% aqueous solution)

Serious Eye Damage/Irritation: Causes serious eye damage. **pH:** 11 - 13.5 (1% aqueous solution)

Respiratory or Skin Sensitization: May cause an allergic skin reaction.

Germ Cell Mutagenicity: Not classified

Carcinogenicity: May cause cancer.

Quartz (14808-60-7)	
IARC group	1
National Toxicity Program (NTP) Status	Known Human Carcinogens.

Reproductive Toxicity: Not classified

Specific Target Organ Toxicity (Single Exposure): May cause respiratory irritation.

Specific Target Organ Toxicity (Repeated Exposure): Causes damage to organs through prolonged or repeated exposure.

Aspiration Hazard: Not classified

Symptoms/Injuries After Inhalation: May cause cancer by inhalation. May cause respiratory irritation.

Symptoms/Injuries After Skin Contact: Causes skin irritation. May cause an allergic skin reaction.

Symptoms/Injuries After Eye Contact: Causes serious eye damage.

Symptoms/Injuries After Ingestion: Ingestion is likely to be harmful or have adverse effects.

Chronic Symptoms: May cause cancer. Repeated or prolonged exposure to respirable (airborne) crystalline silica dust will cause lung damage in the form of silicosis. Symptoms will include progressively more difficult breathing, cough, fever, and weight loss.

SECTION 12: ECOLOGICAL INFORMATION

12.1. Toxicity No additional information available

12.2. Persistence and Degradability

Presstec 2000 and Presstec Standard	
Persistence and Degradability	Not established.

Presstec 2000 and Presstec Standard

Safety Data Sheet

according to Federal Register / Vol. 77, No. 58 / Monday, March 26, 2012 / Rules and Regulations



12.3. Bioaccumulative Potential

Presstec 2000 and Presstec Standard	
Bioaccumulative Potential	Not established.

12.4. Mobility in Soil No additional information available

12.5. Other Adverse Effects

Other Information : Avoid release to the environment.

SECTION 13: DISPOSAL CONSIDERATIONS

13.1. Waste treatment methods

Waste Disposal Recommendations: Dispose of waste material and containers in accordance with all local, regional, national, and international regulations.

SECTION 14: TRANSPORT INFORMATION

14.1 In Accordance with DOT Not regulated for transport

14.2 In Accordance with IMDG Not regulated for transport

14.3 In Accordance with IATA Not regulated for transport

SECTION 15: REGULATORY INFORMATION

15.1 US Federal Regulations

Presstec 2000 and Presstec Standard	
SARA Section 311/312 Hazard Classes	Immediate (acute) health hazard Delayed (chronic) health hazard

Quartz (14808-60-7)

Listed on the United States TSCA (Toxic Substances Control Act) inventory

Cement, portland, chemicals (65997-15-1)

Listed on the United States TSCA (Toxic Substances Control Act) inventory

Limestone (1317-65-3)

Listed on the United States TSCA (Toxic Substances Control Act) inventory

15.2 US State Regulations

Quartz (14808-60-7)	
U.S. - California - Proposition 65 - Carcinogens List	WARNING: This product contains chemicals known to the State of California to cause cancer.

Quartz (14808-60-7)

U.S. - Massachusetts - Right To Know List
U.S. - New Jersey - Right to Know Hazardous Substance List
U.S. - Pennsylvania - RTK (Right to Know) List

Cement, portland, chemicals (65997-15-1)

U.S. - Massachusetts - Right To Know List
U.S. - New Jersey - Right to Know Hazardous Substance List
U.S. - Pennsylvania - RTK (Right to Know) List

Limestone (1317-65-3)

U.S. - Massachusetts - Right To Know List
U.S. - New Jersey - Right to Know Hazardous Substance List
U.S. - Pennsylvania - RTK (Right to Know) List

SECTION 16: OTHER INFORMATION

Revision date

: 02/11/2014

Other Information

: This document has been prepared in accordance with the SDS

GHS Full Text Phrases:

requirements of the OSHA Hazard Communication Standard 29 CFR 1910.1200.

Carc. 1A	Carcinogenicity Category 1A
Eye Dam. 1	Serious eye damage/eye irritation Category 1
Skin Irrit. 2	Skin corrosion/irritation Category 2
Skin Sens. 1	Skin sensitization Category 1

Presstec 2000 and Presstec Standard

Safety Data Sheet

according to Federal Register / Vol. 77, No. 58 / Monday, March 26, 2012 / Rules and Regulations



STOT RE 1	Specific target organ toxicity (repeated exposure) Category 1
STOT SE 3	Specific target organ toxicity (single exposure) Category 3
H315	Causes skin irritation
H317	May cause an allergic skin reaction
H318	Causes serious eye damage
H335	May cause respiratory irritation
H350	May cause cancer
H372	Causes damage to organs through prolonged or repeated exposure

Cintec North America believes the information contained herein is accurate; however, Cintec makes no guarantees with respect to such accuracy and assumes no liability in connection with the use of the information contained herein which is not intended to be and should not be construed as legal advice or as insuring compliance with any federal, state or local laws or regulations. Any party using this product should review all such laws, rules, or regulations prior to use, including but not limited to US and Canada Federal, Provincial and State regulations.

NO WARRANTY IS MADE, EXPRESS OR IMPLIED, OF MERCHANTABILITY, FITNESS FOR A PARTICULAR PURPOSE, OR OTHERWISE.

SDS US (GHS HazCom) - US



GROUT INJECTION KIT



INCLUDES:

- One pressure pot 2.5 liter (10 gal) with preassembled hose and injection valve.
- One Grout mesh screen.
- One mixing paddle with 6" cage.
- Measuring jug marked in liters (or less) increments.
- Three extra injection nozzles
- One Grout Mixing Bucket.
- One water measuring pail.
- Glue gun for anchor repair.



GROUT GUN OPTION FOR SMALL ANCHORS



<https://www.coxdispensers.com/view-products-grid>

- Check for individual models suited for cement up to 30 OZ. -Available in either Battery or Air operated..

Grout Gun option can only be considered for small anchors.

SECTION 3

GROUND ANCHORS

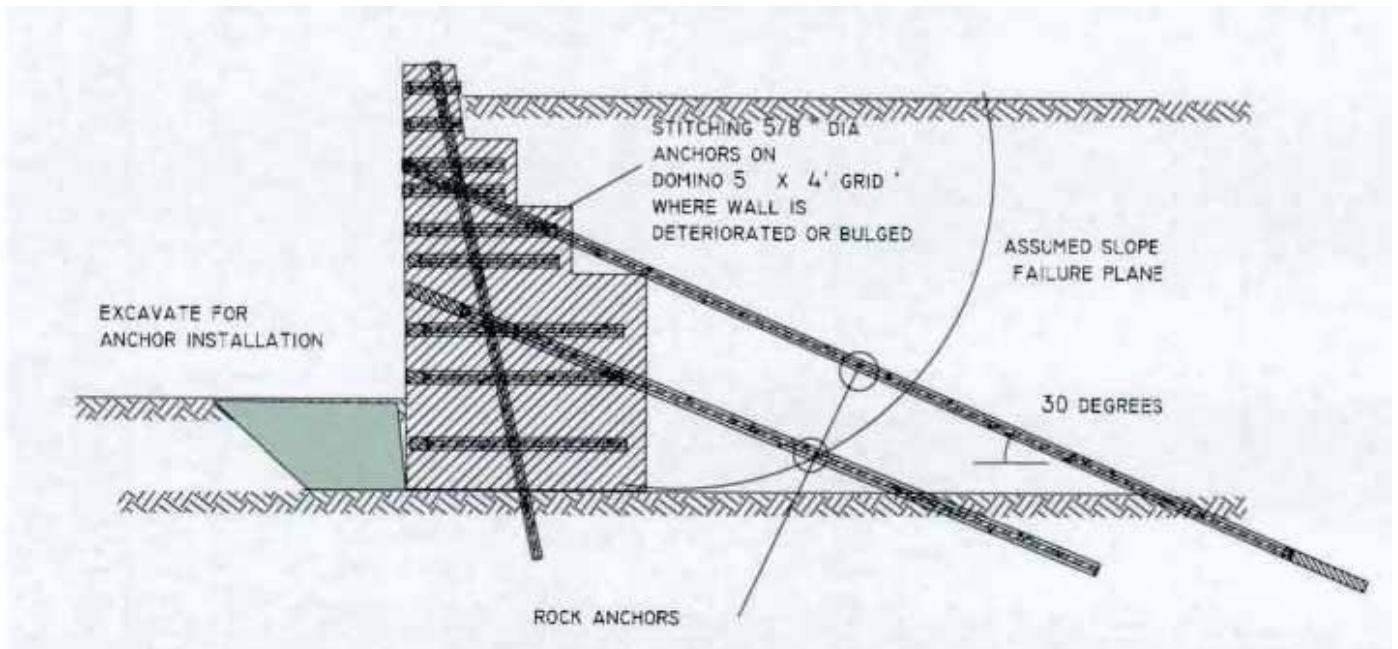
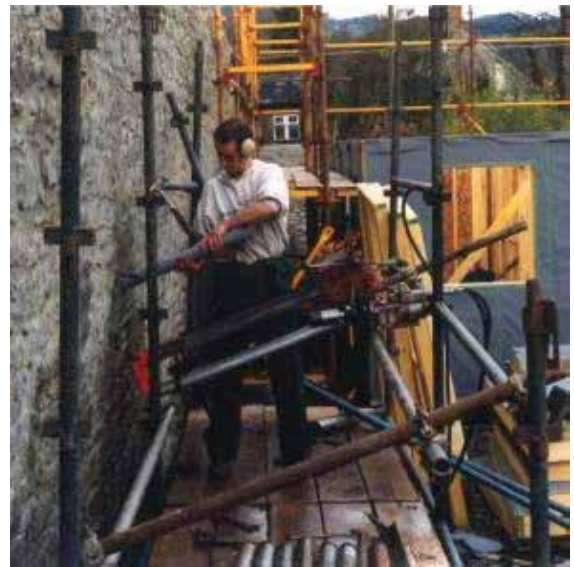

Combi-Tec concealed top termination

Developed by Cintec in conjunction with WT Anchor Systems, the Combi-Tec system comprises a stainless steel tube, front plate and polyester sock which is inserted over the installed anchor before pressure-filling with grout to produce a mechanical and chemical bond within the structure. This provides a totally concealed top termination for Duckbill ground anchors, making it ideal for historic and listed structures.

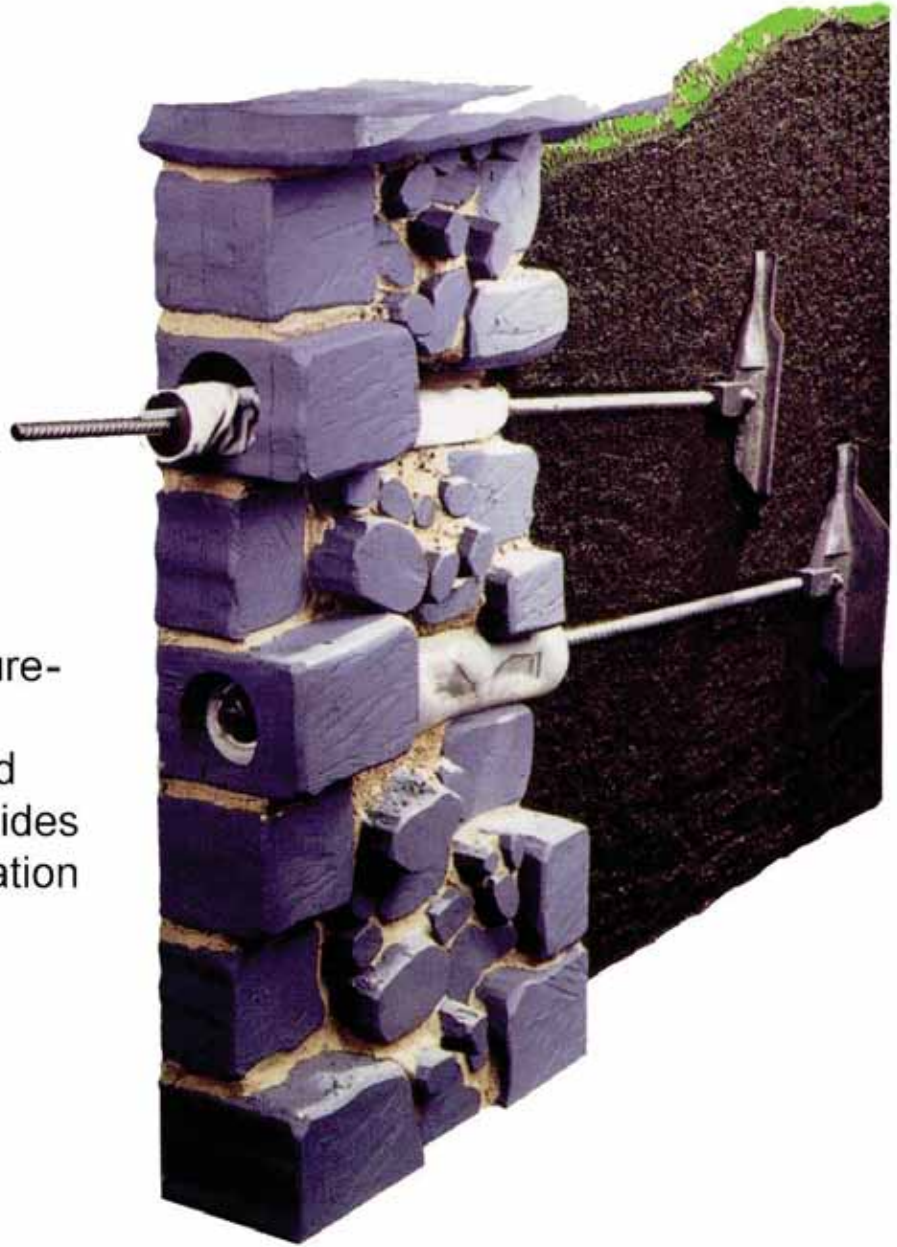

Combi-Tec Ground Anchoring

Combi-Tec is a unique system which provides a totally concealed top termination for its Duckbill ground anchors. It enables structures to be effectively and sympathetically stabilised without any visible disturbance to the fabric or the need for unsightly external pattress plates, making it ideal for historic and listed structures.

After coring out or removing a complete brick or stone, the Duckbill anchor is installed and tensioned to its proof load. The Combi-Tec consisting of a stainless steel tube, circular front plate and special polyester sock developed in conjunction with Cintec, is inserted over the anchor bar with the plate sunk below the surface of the masonry. Cementitious grout is injected into the sock under pressure until it has filled all the voids and, having cured, it forms a chemical/mechanical bond within the wall. The anchor is then re-tensioned to its working load and secured against the recessed plate before the fascia core. Brick or stone is replaced and made good to fully conceal the anchor.

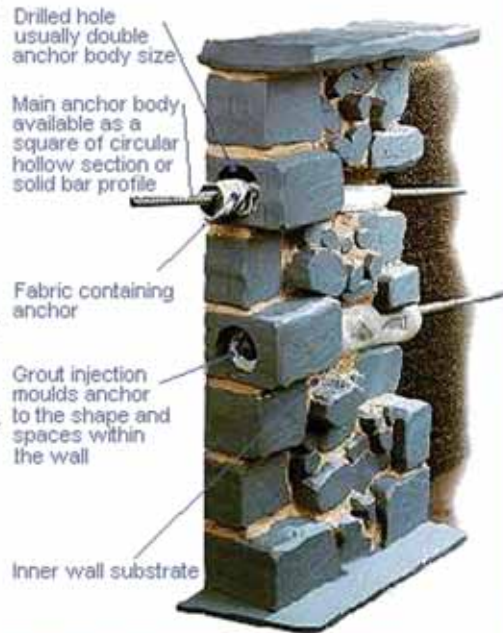

Hand held

1. Remove stone or brick or core drill clearance hole.



2. Position anchor for installation.



3. Drive in anchor to required depth.



4. Insert Combi-Tec over Duckbill anchor



5. Inflate sock by injecting cementitious grout and leave to cure.



6. Tension anchor to working load and secure to recessed front plate with load nut.



7. Crop excess bar, mortar around Combi-Tec



8. Replace cored material and make good

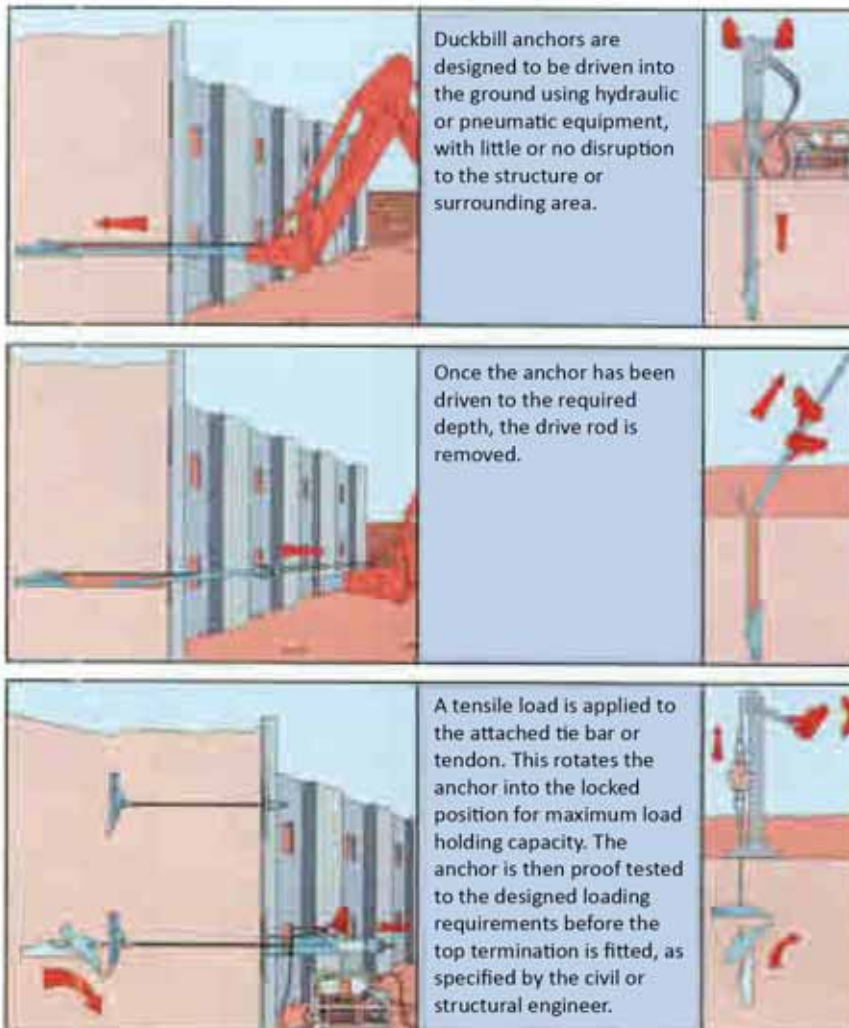

Cintec Ground Anchoring at the Roman Ruins of Bet She'an-Scythopolis - Isreal (2002)



Department of Intercity Railways, British Rail
Railway Bridge 325 Abington/Carlisle Railway

Ground Anchor Stabilization



Installation of Ground Anchors Through Railway Bridge Abutment



Cintec Ground Anchor Installation at bridge 325 Abington

INTRODUCTION:

Cintec International Ltd has developed a system of ground anchors incorporating the patented grout techniques utilised in the Cintec System of anchor fixings. The bridge section of the Civil Engineering Department of Intercity Railways, British Rail, permitted the installation of trial ground anchors through the abutments of bridge number 325 on the Edinburgh / Carlisle Railway line for testing.

GENERAL DESCRIPTION:

In general terms the anchors have the following features:

- a) A high tensile steel bar (ribbed type 2) forming the central element and load transferral mechanism to the abutment wall.
- b) The reinforcement bar has been epoxy coated to provide the first layer of corrosion resistance in accordance with British Standard for Ground Anchors BS8081: 1989.
- c) The corrugated sleeve of UPVC forms the second barrier against moisture and therefore corrosion resistance. The corrugations form a shear key to permit the transfer of forces from the ground to the central bar and then back to the structure.
- d) The elements in a,b and c above are within a polyester fabric sock which expands to contain the pressurised grout, the sock becomes formed to the shape of the cored or drilled hole. Plastic centralisers are used to ensure the correct positioning of the corrugation relative to the bar. Drawings and sketches are attached showing details.
- e) The grout forms the interlocking mechanism between the steel bar and the grout interface. The grout is a patented formulation developed specifically for anchor applications, it is delivered under pressure and is designed to obtain compressive strength capabilities of between 40 – 50 N/mm². Shrinkage is avoided by the use of additives premixed with the grout. The grout itself, being cementitious provides a highly alkaline protective environment against potential corrosion of the steel and the passage of moisture in the unstressed areas.
- f) The sock arrangement used in the trial anchors has features such that the remote end (that which is in contact with the soil) can be inflated independently of the near sock (that which is contact with the structure). With this arrangement the remote end was tested in order to establish the load capabilities. After testing the outer sock was inflated to form the bond with the abutment structure.
- g) Relatively low steel stresses were involved in the anchor testing to eliminate unnecessary elastic extension and subsequential relaxation losses may be neglected.
- h) The outer sock forms a secure bond with the abutment structure thus avoiding the need for unsightly anchor heads visible on the outside.
- i) Each stage of the inflation process is monitored by a 'check sock', that is a small sock that inflates at the external end of the anchor indicating that the remote or unseen sock is fully inflated.

The anchor component parts and design with regard to corrosion resistance comply with the requirements of BS8081: 1989 the British Standard for Ground Anchorage for Permanent Anchors.

INSTALLATION:

From a scaffolded access platform, a mining barrel was used to core the hole through the abutment structure and into the embankment behind. The anchors were inclined at 20° to the horizontal beneath the bridge structure, and at 30° to the horizontal at wing wall locations. The anchors were inserted into the preformed holes and the two sections of the inner sock inflated. The grout is inserted at pressure from a pressurised container (89 PSI, 0.61 N/mm²). The outer sock was not inflated in order that each of the anchors could be subsequently be test loaded.

Sufficient time was permitted for the cementitious grout to cure before any load testing operations were carried out.

GROUND CONDITIONS:

The abutments are located either side of a vehicular access route through the railway embankment. The embankment was built approximately 100 years ago from nearby materials and consisted of gravel, sands with clay and silt. Given the soil profile found, the behaviour of the anchors would inevitably be unpredictable and large resultant test loadings were not anticipated.

TESTING:

The testing was carried out using a hydraulic jack with a calibrated dial gauge measuring the tensile load applied in tonnes. Each of the anchors was tested with the resulting loads tabulated in the following tables. The loads were applied in 4 tonne increments with a minimum of 10 minutes between each rise in the load. Several of the anchors were left for extended periods at the higher loads which coincided with the limit of the testing equipment. One anchor number 2 with the load applied overnight to see if any slippage had occurred. A small relaxation was apparent, although it could not be established if this was due to anchor creep or the testing apparatus deflecting. The location of anchors is indicated in drawing C2162/Sk 1.

The results obtained were of larger magnitude than could have been anticipated given the actual ground conditions. In general the loads obtained varied between 13 – 20 tonnes. The bond stress or cohesion at the soil / interface has been calculated to vary between 81.3 and 219.7 KN/m². Anchor number 1 has an unusually low value of 93.8 KN/m², however this particular hole was left exposed for some considerable time after the mining barrel was removed before the anchors were fitted due to an equipment malfunction which may have led to some localised collapse of the substrate. Anchor number 5 also has an unusually low bond stress of 81.3 KN/m², this anchor was inserted into the area of the sloping embankment, which would not have had the benefit of the loading consolidation as the area underneath the railway tracks. The remaining results varied between 140.6 to a maximum of 219.7 KN/m² which reflects the variable nature of the substrate.

As the sock is inflated under pressure with grout, it expands to fill the shape of the hole, thus filling any irregularities in shape and size. A combination of different factors is anticipated to develop the load capacities obtained as follows.

- 1) Forming an irregular wedge by the shape of the hole and sock inflation, thus creating the need to shear the soil in order for the anchor to fail.
- 2) The grout 'milk' extrudes through the sock and partially bonds to the surrounding granular material, thus enlarging the effective diameter of the anchor.
- 3) Localised compaction of the surrounding material due to the pressurised grout inflation.

The installation and testing was witnessed by:

Mr Kader of British Rail Intercity Civil Engineering Dept.
 Mr Barnet of British Rail Intercity Civil Engineering Dept
 Mr Dimmick of Cavity Lock Systems (now Cintec International).
 Mr Parry of Cavity Lock Systems (now Cintec International).
 Mr Woodhouse of Fordham: Johns Partnership.

The anchors were installed in the period February – May 1992 and tested between June 1992 and December 1992.

DESIGN OF ANCHORS:

The following outlines the basic principals involved in assessing the design parameters and considerations in relation to the capacity of the ground anchors.

STEEL TENDON

The steel tendon in the anchors tested comprised of a high tensile steel bar, (epoxy coated for protection).

The bar area was established by the formula:
$$\text{Area required} = \frac{\text{Load}}{F_y}$$

Where:- Load = working load multiplied by an appropriate factor of safety (200Kn)
 F_y = characteristic strength of the steel (460 N/mm²).

For the test anchors, the area required =
$$\frac{200 \times 10^3}{460} = 434.8 \text{ mm}^2$$

Bar diameter 40mm provides area of 1256 mm², F.O.S. = 2.88
 Bar diameter 32mm provides area of 804 mm², F.O.S. = 1.85

The steel stresses in this case were maintained at the low levels shown in order to avoid significant elastic extensions and therefore potential relaxation losses.

The steel bar utilised in the tests was a high yield ribbed bar (type 2) which has raised ribs on the surface for increased bond capability.

The bond between the grout and the bar can be established from the equation:-

$$F_{bu} = B\sqrt{f_{cu}} \quad \text{where } f_{bu} = \text{the design ultimate anchorage bond stress.}$$

$$F_{bu} = 0.7\sqrt{40} \quad B = \text{coefficient dependent on type } (0.5 \times 1.4 = 0.7)$$

$$= 4.43 \text{ N/mm}^2 \quad f_{cu} = \text{compressive strength of grout } (40 \text{ N/mm}^2)$$

DESIGN OF FIXED ANCHOR LENGTH:

The pull out capacity of the test anchors can be shown as:- $T_f = \pi D L S$

Where S = the shear, bond and skin friction at Substrate/rock interface (Kn/mm²)

D = diameter of fixed anchor (m)

L = Length of fixed anchor (m)

T_f = pull out capacity in (Kn)

The values of S varied between 81.3 to 219.7 Kn/m². For design purposes the lowest value should be used and a factor of safety of 4 utilised to limit ground creep in permanent anchors.

For design of anchors at specific locations the nature and behaviour of the substrate must be established by testing. Full-scale load tests are recommended to confirm laboratory results.

FIXED ANCHOR DESIGN IN ROCK

$$T_f = \frac{\pi D L T_{ult}}{\text{Factor of Safety}} \quad \text{Where } T_{ult} = \text{the ultimate bond or skin friction at sock / rock interface.}$$

The value of T_{ult} will vary dependant on rock type, condition and discontinuities. A minimum fixed anchor length of 3m is recommended to account for local variations and a factor of safety of 3 to 4 be applied dependent upon the circumstances of usage.

FIXED ANCHOR DESIGN IN COHESIONLESS SOILS

The substrate at the testing location falls into this category although clay and silts were present.

$$T_f = \frac{\pi D L S}{\text{Factor of Safety}}$$

The value of S must be found by testing. A factor of safety of 4 should be used and a minimum length of 4m is recommended.

FIXED ANCHOR DESIGN IN COHESIVE SOILS

$$T_f = \frac{\pi D L \alpha C_u}{\text{Factor of Safety}} \quad \text{Where } \alpha = \text{adhesion factor } 0.3 - 0.45 \text{ verified by testing.}$$

$$C_u = \text{average undrained shear strength of substrate.}$$

The value α and C_u must be found by laboratory tests or full-scale tests. The factor of safety should be of the order of 3 to 4 and a minimum length of 3m is recommended dependent upon consistency.

ANCHOR BOND TO STRUCTURE

Should the anchor be required to bond to the structure (as opposed to an anchor head arrangement) the following equation may be used:-

$$T_s = \frac{\pi D L B}{\text{Factor of Safety}} \quad \text{Where } T_s = \text{ultimate bond to the structure material (Kn)}$$

$$B = \text{bond between sock and structure (Kn/m}^2\text{)}$$

DISCUSSION

The general conditions at each location will dictate the design stresses to be used in assessing the ultimate capacity of an individual anchor. Where laboratory tests are not available, full-scale insitu tests are required to establish the lower bounds of the substrate capacity.

A minimum fixed anchor length of three metres is recommended to account for local variables in substrate conditions.

In order to reduce the possibility of long term ground creep, factors of safety should be applied. These factors should be of the order of 3 to 4 dependent on soil consistency, life expectancy and their importance to the structure.

The fixed anchor length must be located beyond the critical zone, such as the wedge failure, slip circle, rock discontinuities in order to be effective. The free anchor length will depend upon the geometry of the location.

The anchors can act as a restraint, only accepting load if movement occurs, or they can be pre-stressed to a set load to provide an active force.

A feature of the Cintec System is that a choice of connections can be achieved with regard to fixing to structure. Traditional anchor head details may be used where periodic re-stressing or monitoring is required. Where the structure is suitable, the anchor may be bonded to the material as a permanent fixing, without the requirement for surface apparatus.

GENERAL DESIGN CONSIDERATIONS

Where ground anchors are being utilised, careful consideration should be given by the designer to the following points:-

- a) Detailed field and laboratory tests to establish soil characteristics.
- b) Full-scale load tests to confirm laboratory predictions.
- c) Assessment of consequences of potential long-term creep.
- d) Overall length of anchor, fixed anchor length, failure planes.
- e) Effects of anchor groups if anchors closely spaced.
- f) Likely stress losses due to tendon relaxation.
- g) The free anchor length can be released from the grout by use of smooth tubes forming the second barrier of corrosion resistance, thus avoiding stressing ground close to structure.
- h) The factor of safety to be applied.
- i) Reference should be applied to the British Standard BS.8081 : 1989 or other appropriate document for advice on usage and design.

CONCLUSION

The testing of the ground anchors showed that the Cintec System could be successfully used in even the most difficult of ground conditions and achieve results in excess of expectations.

Careful appraisal of all factors must be given by the designer, to the points raised in the design considerations section, in order to fully realize the potential of the system.



S. WOODHOUSE B. Eng (Hons) C.Eng M.I.Struct.E.

23rd APRIL 1993

Date: April 1993 Scale: / Drawing No: C2162/Sk 1
 Drawn: J.S. Design S.W. Project: BRIDGE 325, ABINGDON
 Drawing Title: GROUND ANCHOR DETAIL TO ABUTMENTS

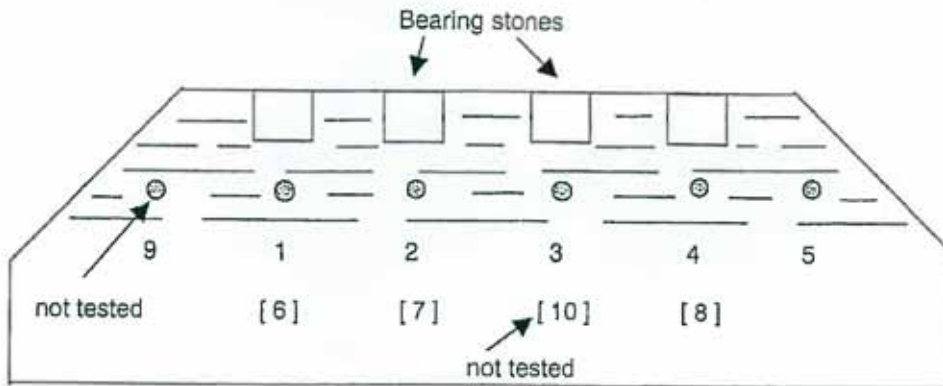

ELEVATION OF NORTH & SOUTH ABUTMENT SHOWING GROUND ANCHORS
 SOUTHERN ANCHORS 1 – 5
 NORTHERN ANCHORS 6 - 8

ANCHOR NUMBER	ANGLE OF INCLINATION	TOTAL LENGTH (M)	FIXED ANCHOR LENGTH OR LENGTH OF EMBEDMENT (M)	HOLE DIAMETER (MM)	TEST LOAD [T]
1	20°	5.45	4.1	124	15
2	20°	3.95	2.6	124	18
3	20°	3.45	2.1	124	18
4	20°	3.95	2.6	124	19
5	30°	5.45	4.1	124	13
6	20°	4.45	3.1	124	18
7	20°	4.45	3.1	124	17
8	20°	4.95	3.6	124	20

Date: April 1993 Scale: / Drawing No: C2162/Sk 3
 Drawn: J.S. Design S.W. Project: BRIDGE 325, ABINGDON
 Drawing Title: GROUND ANCHOR TEST RESULTS

Anchor number	Angle of inclination	Total Length (m)	Fixed anchor length or length of embedment (m)	Hole diameter (mm)	Soil anchor interface (mm ²)	Test Load (T)	Test Load (KN)	Shear stress Soil / anchor Interface (N/mm ²)	Shear stress soil anchor interface (KN/m ²)
1	20°	5.45	4.1	124	1.599x10 ⁶	15	150	0.0938	93.8
2	20°	3.95	2.6	124	1.014 x10 ⁶	18	180	0.1775	177.5
3	20°	3.45	2.1	124	0.819 x10 ⁶	18	180	0.2197	219.7
4	20°	3.95	2.6	124	1.014 x10 ⁶	19	190	0.1873	187.3
5	30°	5.45	4.1	124	1.599 x10 ⁶	13	130	0.0813	81.3
6	20°	4.45	3.1	124	1.209 x10 ⁶	18	180	0.1488	148.8
7	20°	4.45	3.1	124	1.209 x10 ⁶	17	170	0.1406	140.6
8	20°	4.95	3.6	124	1.404 x10 ⁶	20	200	0.1424	142.4

Date: April 1993 Scale: / Drawing No: C2162/Sk 2
Drawn: J.S. Design S.W. Project: BRIDGE 325, ABINGDON
Drawing Title: GROUND ANCHOR DETAILS

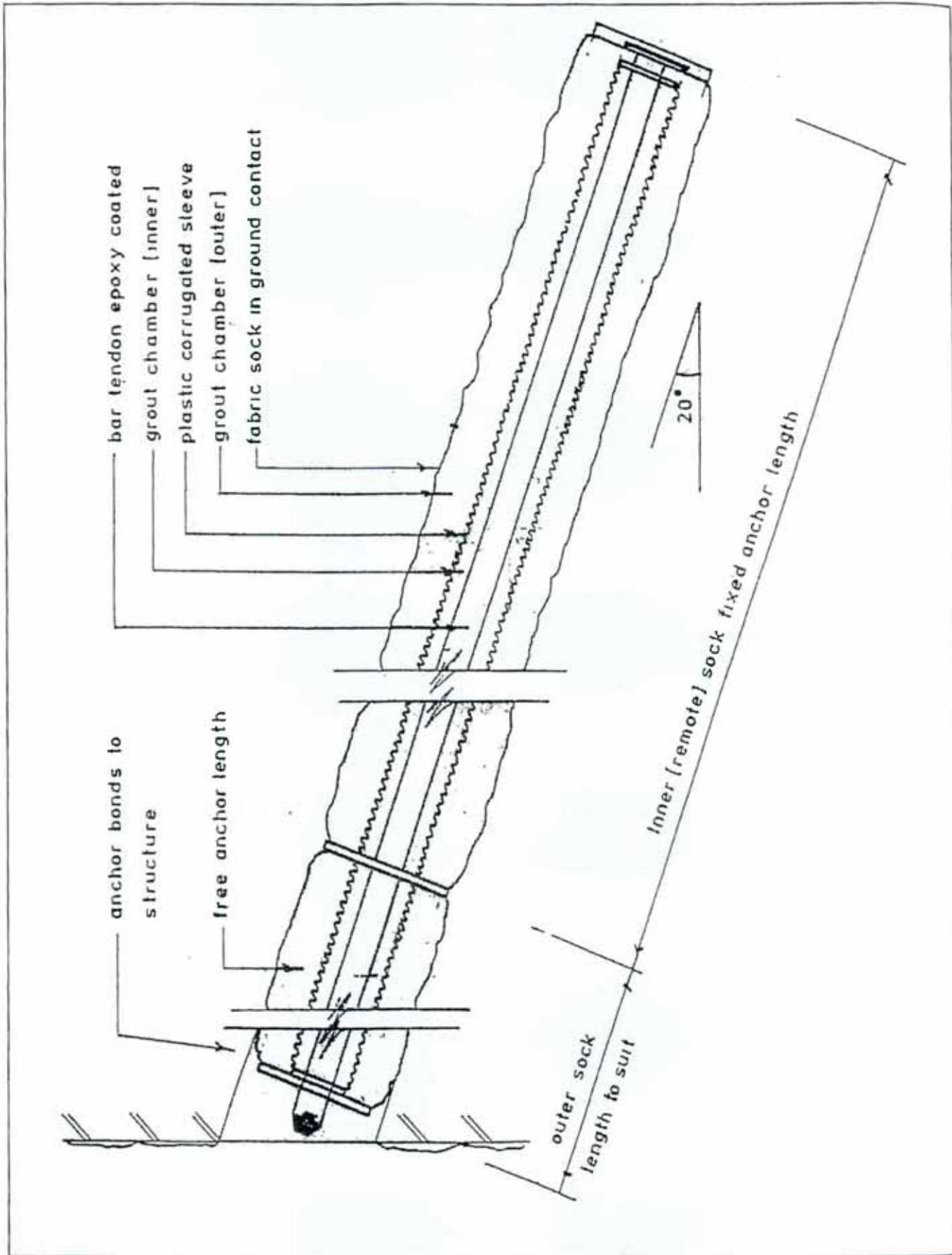

SECTION 4

PART 1: EARTH RETAINING WALLS , CASE HISTORIES & STRENGTHENING of PARAPET WALLS

PART 2: WATER RETAINING / MARINE STRUCTURES & CASE HISTORIES



Nigeria Africa



ZeebruggeHarbour Belgium



Cintec anchors being lifted into place Quebec Canada



Schewerin Castle Germany



Roman Ruins Isreal



Florida USA

SECTION 4

PART - 1

EARTH RETAINING WALLS - CASE HISTORIES

&

STRENGTHENING of PARAPET WALLS



SHEWERIN CASTLE ROCK-GERMANY



BET SHE'AN ROMAN RUINS ISREAL

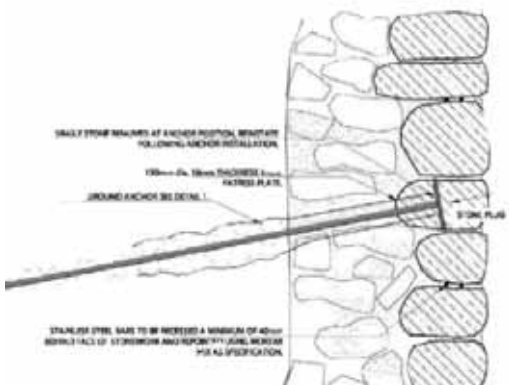

BLAISE CASTLE UK



WALES



The Strengthening and Stabilisation of Masonry Retaining Walls by Cintec North America



Masonry Retaining Walls:

Typical Problems · Investigation · Designing · Testing · Solutions · Examples

· **Typical Problems**

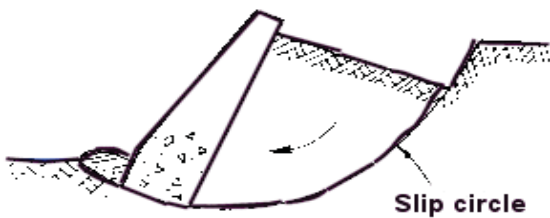

Slip circle

Deep seated failure

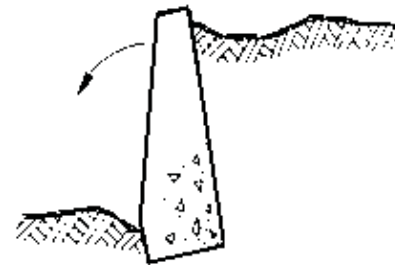

Failure by Rotation

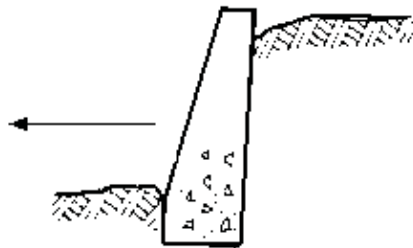

Failure by Sliding

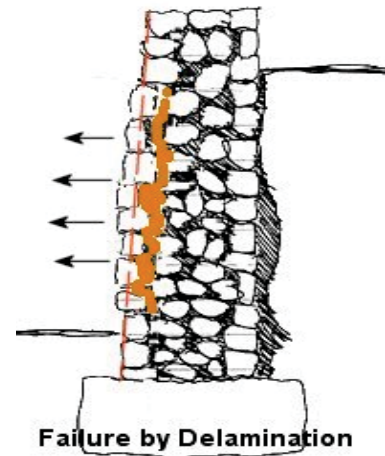

Failure by Delamination

Copyright © Cintec International Ltd 2012 all rights reserved. NO part of this publication may be reproduced or transmitted in any form or by means, electronic or mechanical, including photocopying, recording or any information storage or retrieval system without prior written approval from Cintec.



**Masonry Retaining Walls:
Typical Problems**

· **Investigation** ·



**Investigative cores are taken to determine the wall thickness,
type of material within the wall and the consistency of the retained material.
This will enable a design to be established regarding the location of the Cintec ground anchors.**



Copyright © Cintec International Ltd 2012 all rights reserved. NO part of this publication may be reproduced or transmitted in an any form or by means, electronic or mechanical, including photocopying, recording or any information storage or retrieval system without prior written approval from Cintec.



Masonry Retaining Walls:
Typical Problems ·
 · **Designing** ·

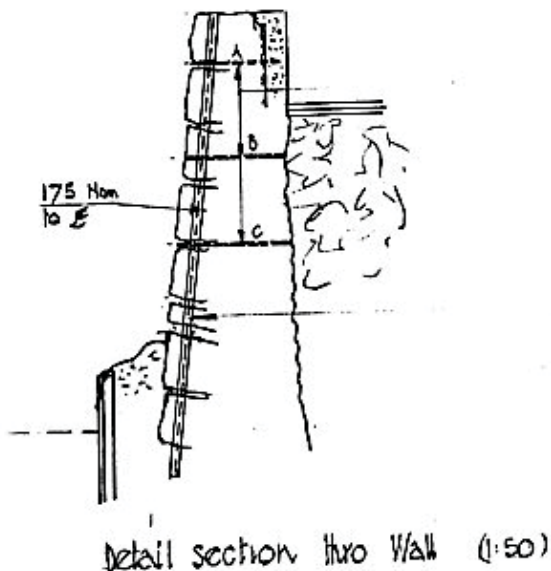
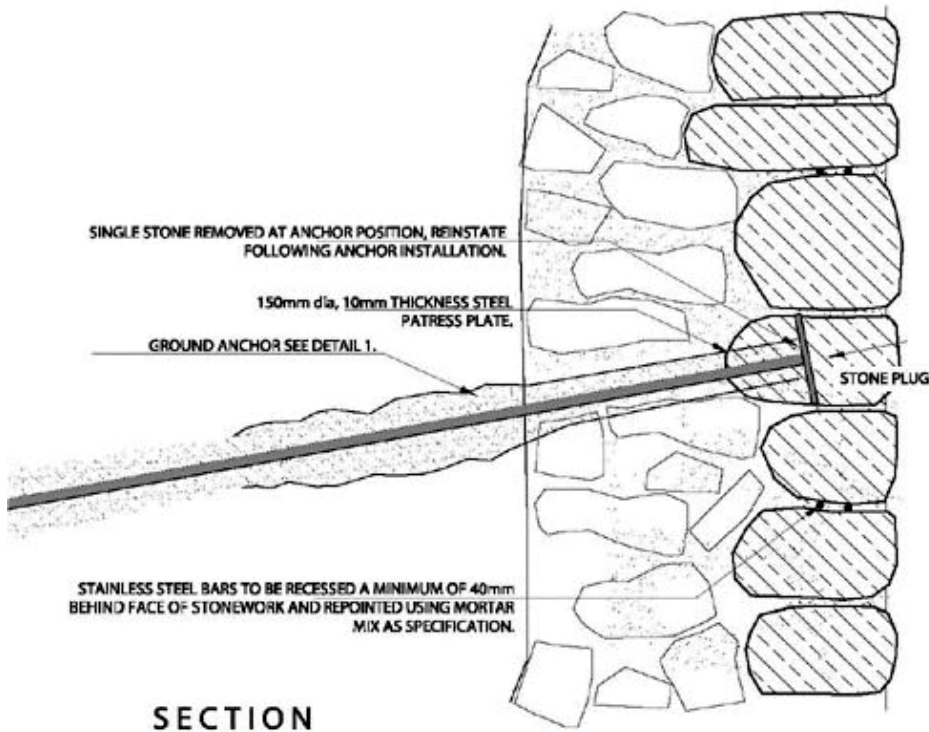

GENERAL DESIGN CONSIDERATIONS

Where ground anchors are being utilised, careful consideration should be given by the designer to the following points:-

- a) Detailed field and laboratory tests to establish soil characteristics.
- b) Full-scale load tests to confirm laboratory predictions.
- c) Assessment of consequences of potential long-term creep.
- d) Overall length of anchor, fixed anchor length, failure planes.
- e) Effects of anchor groups if anchors closely spaced
- f) Likely stress losses due to tendon relaxation.
- g) The free anchor length can be released from the grout by use of smooth tubes forming the second barrier of corrosion resistance, thus avoiding stressing ground close to structure.
- h) The factor of safety to be applied.
- i) Reference should be applied to the British Standard BS.8081 : 1989 or other appropriate document for advice on usage and design.



Masonry Retaining Walls: Typical Problems

Testing ·



IN-SITU LOAD TESTING THE CINTEC GROUND ANCHOR

A feature of the Cintec System is that a choice of connections can be achieved with regard to fixing to structure. Traditional anchor head details may be used where periodic re-stressing or monitoring is required. Where the structure is suitable, the anchor may be bonded to the material as a permanent fixing, without the requirement for surface apparatus.

The general conditions at each location will dictate the design stresses to be used in assessing the ultimate capacity of an individual anchor. Where laboratory tests are not available, full-scale in-situ tests are required to establish the lower bounds of the substrate capacity.

A minimum fixed anchor length of three metres is recommended to account for local variables in substrate conditions.

In order to reduce the possibility of long term ground creep, factors of safety should be applied. These factors should be of the order of 3 to 4 dependent on soil consistency, life expectancy and their importance to the structure.

The fixed anchor length must be located beyond the critical zone, such as the wedge failure, slip circle, rock discontinuities in order to be effective. The free anchor length will depend upon the geometry of the location.

The anchors can act as a restraint, only accepting load if movement occurs, or they can be pre-stressed to a set load to provide an active force.



Masonry Retaining Walls: Typical Problems Solutions

The following pictures show the process of drilling for, installing and grouting the Cintec Ground Anchors.



Setting up the drilling rig



The drilling head



Adding mining barrel extensions



Mining barrel extensions



Drill head at full depth



Inserting plastic tube liner to the drilled hole



Cintec anchor in its packing protects until needed



Removing anchor from the packing



Ready to insert anchor



Carefully placing the anchor



Making sure the sock is not bunched up at the end



Final few feet going in



Extracting the tube liner



Removing the tube liner



Copyright © Cintec International Ltd 2012 all rights reserved. NO part of this publication may be reproduced or transmitted in any form or by means, electronic or mechanical, including photocopying, recording or any information storage or retrieval system without prior written approval from Cintec.



Masonry Retaining Walls:

Typical Problems

· Examples ·

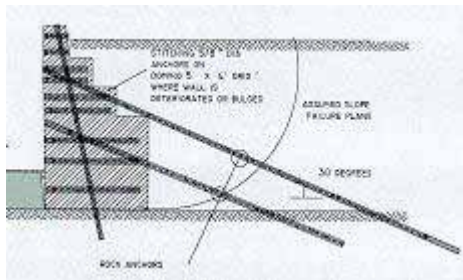

New York Retaining Wall - Rotation & Delamination

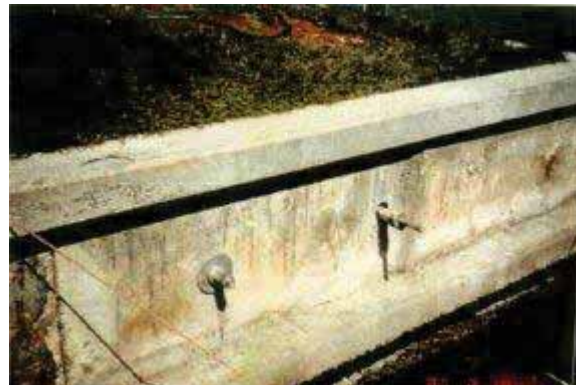

Florida Sea Wall - Subsidence & Dislocation

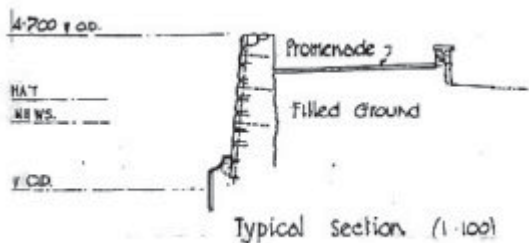

Goodrington Sea Wall - Sliding & Delamination



Blaise Castle Wall - Sliding

WANTAGE TOWN WALL, Berkshire



As found shored upDrilling and installing Cintec ground anchors

Copyright © Cintec International Ltd 2012 all rights reserved. NO part of this publication may be reproduced or transmitted in any form or by means, electronic or mechanical, including photocopying, recording or any information storage or retrieval system without prior written approval from Cintec.



Mesh and face plates secured.....Final lime rendered finish applied



Malmesbury Town Wall - Deep Seated & Rotation

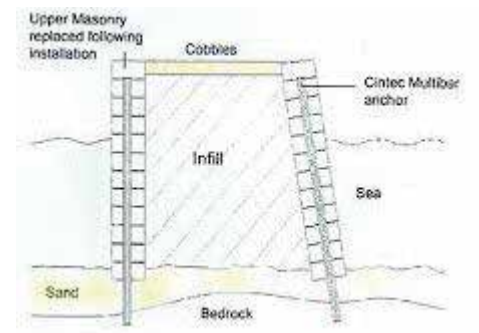

Hay's Dock, Lerwick - Subsidence & Sliding

Copyright © Cintec International Ltd 2012 all rights reserved. NO part of this publication may be reproduced or transmitted in any form or by means, electronic or mechanical, including photocopying, recording or any information storage or retrieval system without prior written approval from Cintec.

RETAINING WALL STABILISATION, ST GEORGE'S ROAD, SHANKLIN, ISLE OF WIGHT

A failing retaining wall adjacent the public footpath and highway posed a danger to pedestrians, traffic and occupants of the dwelling behind the wall.



The wall was on the brink of collapse and temporary support provided by scaffolding. The works comprise the design and installation of horizontal and vertical Cintec ground anchors and consolidation anchors to stabilise a failing stone retaining wall. The wall forms the boundary of the plot with the adjacent pavement.

A survey and ground investigation had been carried out by Shire Associates thereby permitting the structural engineer retained by Cintec International to proceed with a design solution. The design by Epc evaluated the adequacy of the scaffolding as part of the design. The design evolved to take into account soil data from trial pit reports and soil / construction details exposed whilst piling. It was essential that the drilling operations and anchor installation did not disturb the temporary support and cause it to fail

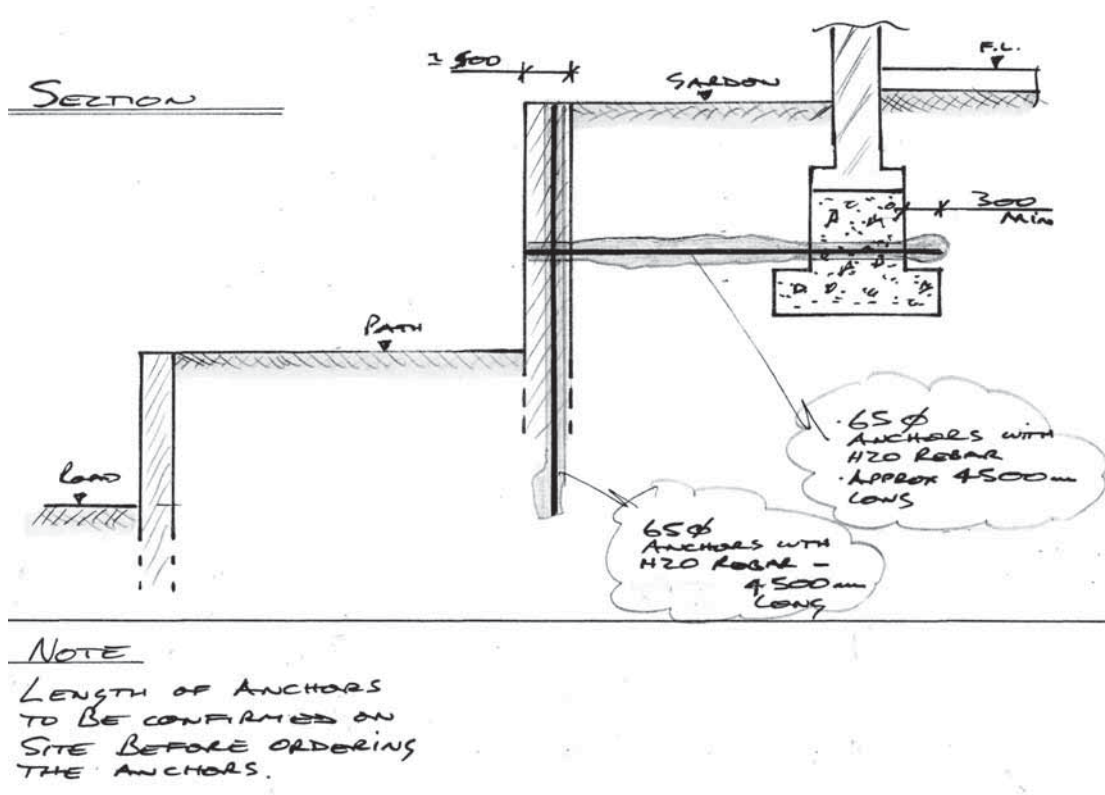

NOTE

LENGTH OF ANCHORS TO BE CONFIRMED ON SITE BEFORE ORDERING THE ANCHORS.

Chester City Wall reinstatement and repairs

The city walls are the oldest, longest and most complete in Britain, parts of which are almost 2000 years old. Chester is the only city in Britain that retains the full circuit of its ancient defensive walls. Walking the complete circuit gives wondrous views down into the city and gives a fantastic insight into Chester's long history.



A 30-metre section of the **walls**, which date back to Roman and medieval times, **collapsed** in April **2008**. Structural Engineers Ramboll (formerly Gifford) were commissioned with the delicate and complicated task of reconstruction and repair.

Cintec International was the natural choice for Ramboll given their specialist experience in a similar project at Rochester Castle and City walls.

A complicating factor in both design and installation of the anchors was the temporary shoring which had been necessarily erected to prevent further collapse of the wall adjacent to the collapsed section.

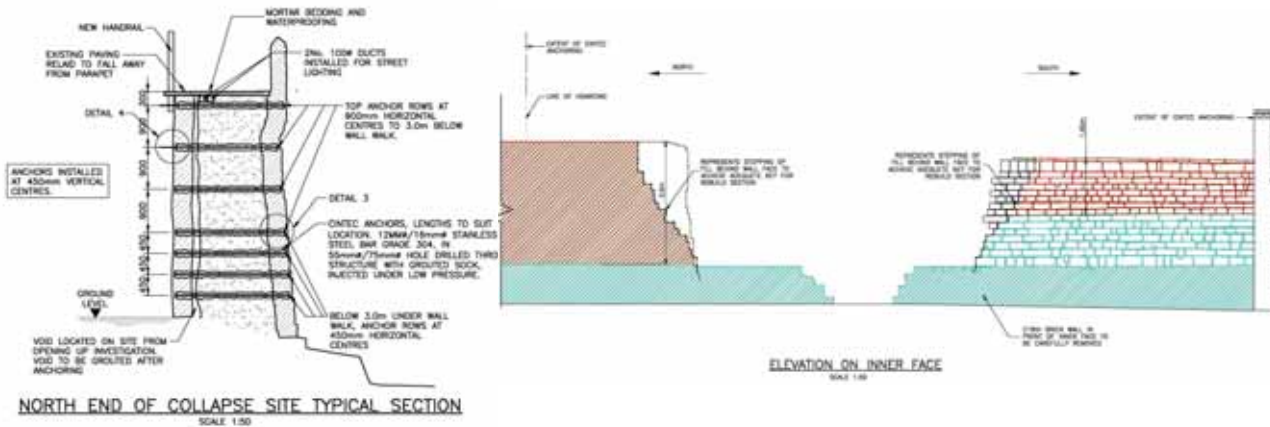

The areas of wall adjacent to the collapse were consolidated with Cintec anchors inserted on a grid pattern and of varying lengths and diameters according to the loading which increased nearer to the base of the wall.

The re-built sections also had Cintec anchors installed into the remaining core and backing of the wall but with a threaded connector at the exposed end of the anchor to allow a 6mm dowel to be built-in to the replaced masonry facework.

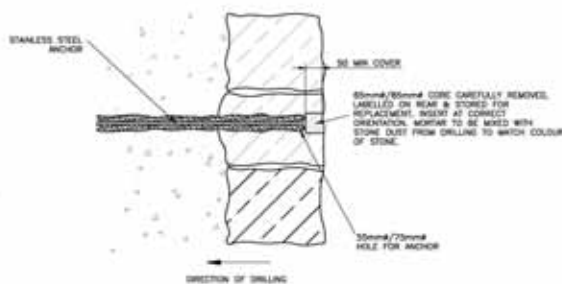

Image at the right shows retained cores which were replaced after anchoring in the stonework to create an invisible repair.



The Great Wall, Hampstead Garden Suburb, London

The Great Wall faces onto the Hampstead Heath Extension within Hampstead Garden Suburb.

The wall was built c. 1914. It is listed grade II and within the Hampstead Garden Suburb Conservation Area. Currently the wall is out of plumb by up to 100mm (4"). The proposed works are the permanent support by ground anchors to two sections of out of plumb part wall to the rear of the gardens with Nos. 8 and 10 Linnell Drive.



The existing brick built wall was only 9 inches thick but had a concrete backing at the low level. The cause of the out of plumbness was determined to be increased surcharge by raised garden levels behind the wall and the adverse effects of tree roots in close proximity to the rear of the wall.

The solution was to install Cintec ground anchors to provide the required stability to the wall to prevent further rotation and to resist the ground pressure behind the wall.

A total of 13 No anchors were installed consisting of Cintec 20mm diameter grade 304 stainless steel ground anchors 6.00m long.

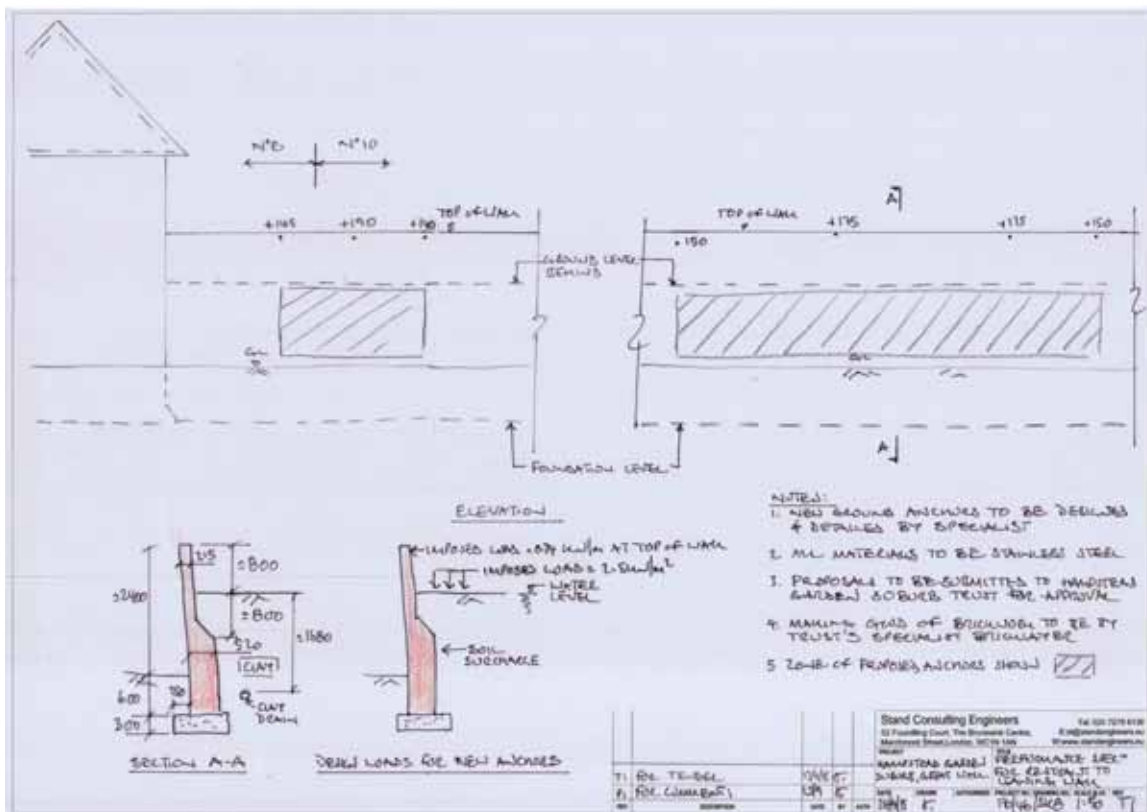

The ground anchors were Cintec 20mm diameter 6.00 metres long in 65mm diameter core drilled holes with the front end recessed behind the outer skin of brick. Anchors were installed at a 15 degree angle to horizontal and at 1 metre horizontal intervals at the third point of the height of the retained material.

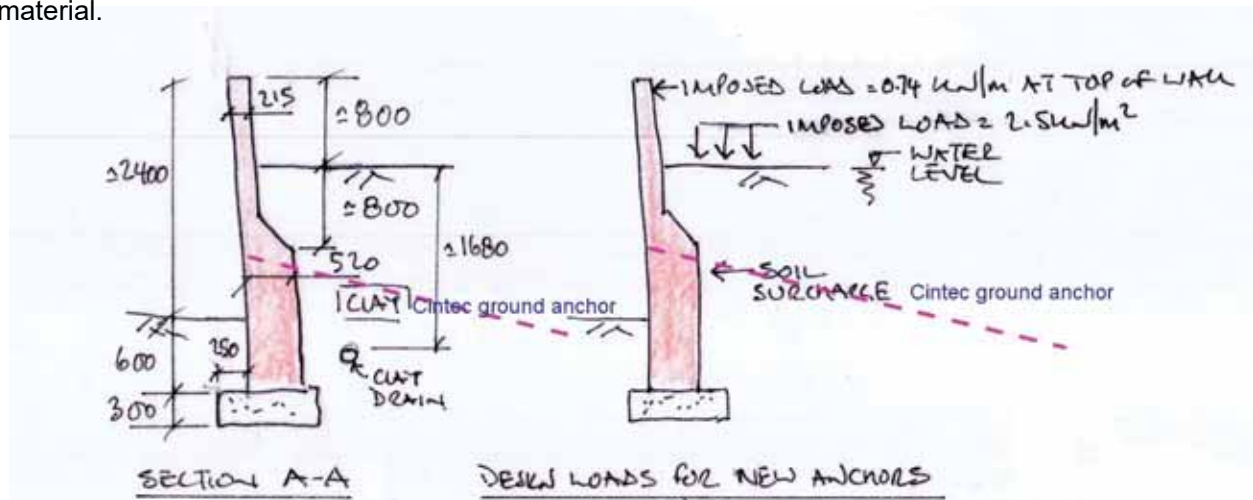

The drilling rigs were carefully bolted to the wall and the hole drilled where a half-brick outer leaf had been removed. The drilling was carried out with water cooled mining barrels to prevent collapse of the holes in loose material.



The anchors were inserted through the mining barrels when drilling complete and cores removed. The barrels were then extracted and the anchors grouted, filling tubes cut off and the half-brick outer leaf replaced to completely conceal the anchors.

Malmesbury Town Wall



In order to maintain the structural integrity of the wall, English Heritage advised the specification of Cintec ground anchors for a number of phases for the work. Stability was returned to the wall by inserting Cintec ground anchors through the thickness of the wall and into the clay and limestone behind.

Diamond drilling (right) and anchor insertions (left).



The 12th Century Town Wall at Malmesbury in Wiltshire is being restored as part of an ongoing conservation project involving the Conservation Department of North Wiltshire District Council in conjunction with English Heritage.

The random rubble wall is constructed from locally quarried limestone up to 1.50 metres in thickness, however erosion of adjoining earth and the effects of time had taken their toll resulting in localised delamination and rotation.



The anchors were installed through the joints of the stonework following the completion of gravity grouting of extensive voids within. To facilitate this process clay was used to seal the open joints between the stones in order to retain the original historic grouting. This was later removed and the wall pointed with lime mortar to match the original material. The Cintec ground anchors were tested to a working load of 15kN. Other, smaller Cintec anchors were also used for wall consolidation.

Load - Start	Time Held	Load - End	Extension	Extension		Test Date: 20/08/97
2	2 Mins	2				TEST CERTIFICATE
4	2 Mins	3.75				Type of Test: Tensile loading
6	2 Mins	6				Anchor Type
8	2 Mins	8				20 x 20 x 4000mm
10	2 Mins	10				Embedment Depth
12	5 Mins	12			Site Address	1000mm
14	2 Mins	14			Malmesbury Malmesbury Town Wall	Bore Hole Diameter
Company Name:			Engineers Name:		Anchor Location	Base Material
Quicksons			John Avent		Top Right Section	Clay/Rubble
Company Address:			Engineers Address:		Comments	Required Load
Unit 1 Whiteaway Court Cirencester Gloucestershire			Mann Williams 4 Palace Yard Mews Bath BA1 2N11		Initial drop in load due to bedding in' against a clay embankment	12 Kn
Persons Present			Company		Position	Grout Type
Dennis Lee			Cintec International Limited		Technical Advisor	Presstec standard
John Brooks			Cintec International Limited		Area Sales Manager	Anchor Material
Andy			Minerva Stone Conservation		Foreman	Stainless Steel

Nantgarw Pottery Works Wall - Glamorganshire, South Wales, U.K.

Nantgarw pottery rivaled that of Swansea in the 17th Century for its high quality earthenware, in recognition of its historical importance, the local authority wished to restore one of the now derelict bottle kilns. The location of the proposed rebuild kiln was immediately adjacent to an ancient stone retaining wall. The 2 meter high wall was constructed from random rubble using local stone and was bedded and jointed using black ash mortar. There was concern that this wall would not withstand the additional imposed loading from the rebuilt kiln.



Insertion of 3m Cintec Anchor (left). Its inflation using cementitious grout, (above).

The structural engineers, ove arup working in conjunction with protechahome, opted to specify Cintec ground anchors to stabilize the wall and provide resistance to the additional horizontal forces imposed by the kiln.

Cintec ground anchors were installed horizontally through the bed joints and into the ground infill retained behind it. This infill comprised mainly of broken brick, stone, clay, pottery shards and other assorted material. The core drilling technique employed to create the holes also revealed many voids within it, a significant feature of the Cintec anchor is its ability to bridge such gaps by retaining the flow of grout with its polyester sleeve. The 3 meter long Cintec anchors were installed at 1 meter horizontal intervals and tested to a working load of 15kN each.



The process of diamond drilling (below). With the subsequent core samples produced, (left).



The restoration and stabilization of the Blists Hill Furnaces



Mark Goring, Barnsley Associates Limited, Consulting Civil and Structural Engineers, discusses the restoration programme that is helping to preserve a historic site.

The restoration and stabilization of the Blists Hill Furnaces

Mark Goring, Barnsley Associates Limited, Consulting Civil and Structural Engineers, discusses the restoration programme that is helping to preserve a historic site

Introduction

The repair and restoration of the Blists Hill Furnaces, which form part of the Blists Hill Open Air Museum Site near Ironbridge, Telford, has recently been completed. The works were instigated as part of a major repairs programme designed to renovate, and restore, numerous structures within the Ironbridge Gorge Heritage site.

A detailed repair schedule was prepared for each of the sites by a working party, including architects, civil and structural engineers, surveyors and archaeologists and the work funded by the Department of the Environment.

The purpose of the repair work was to restore and renovate the properties and structures to an acceptable condition whereby the ownership and future maintenance of the structures would pass into the care of Ironbridge (Telford) Heritage Foundation.

In order to bring about the restoration and stabilisation of the Blists Hill Furnaces, it was necessary to undertake remedial work on the existing brickwork and stonework, together with the introduction of extensive ground anchors and tie bars.

Work required to prevent further ingress of surface ground water into the furnaces was undertaken as a separate, but integral, phase of the works.

Background history

The Madeley Wood Company was formed in 1756 when the ironworks at Bedlam, one mile west of Blists Hill, on the River Severn, was founded. The Bedlam Furnaces were owned by this company, which held mineral leases in Madeley Parish, enabling it to extract coal and iron ore. Upon its opening in 1790, the company had access to the Shropshire Canal, the Blists Hill section of which ran immediately to the east of the Blists Hill works site. Proximity of raw materials and the means of transporting the finished product persuaded the company to build a blast furnace at Blists Hill in 1832.

Additional furnaces were added in 1840 and 1844, making a total of three, and the site remained active in the production of pig iron until 1912 when the ironworks ceased production, following the blowing in of two of the furnaces.

The site history through the 20th century is less well documented. Dense vegetation cover was allowed to establish itself amongst the ruins until the late 1950s when the site was subject to spoil dumping, which completely buried the furnace bases. In the 1970s the Ironbridge Gorge Museum Trust began clearing and restoring the works.

Structural defects

The buildings had fallen into poor repair due to the ravages of time and the ingress of ground water. This dereliction and general instability of the furnace structures represented a hazard to the preparation of a specification for the repair. It was, therefore, necessary to undertake the design and

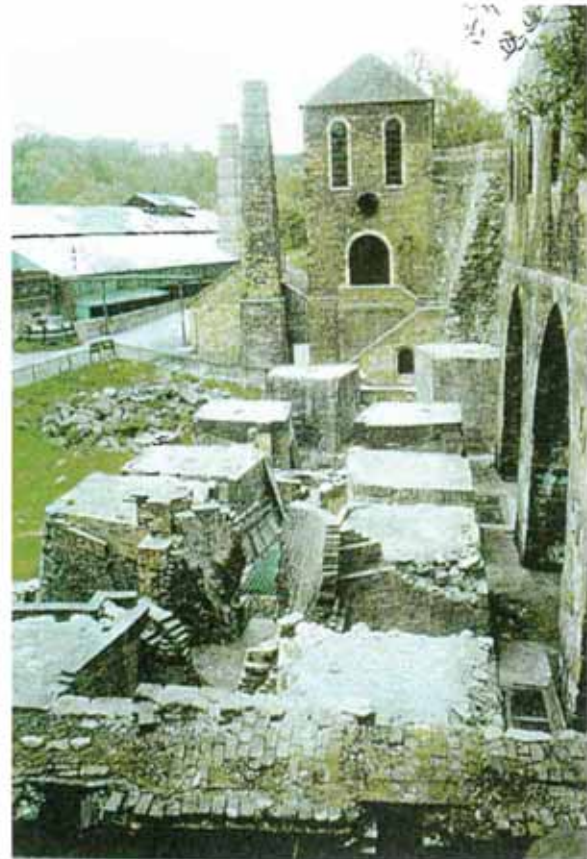

Blists Hill Furnaces' structure was originally built in 1832, with additional furnaces being added in 1840 and 1844.

installation of an extensive scaffold propping scheme to enable the facade of the structure to be stabilised sufficiently to enable the appraisal and detailing of repair work.

The scale of works was restricted due to the nature, historical and archaeological importance of the site. Problems were encountered during the design stage of the scheme due to the presence of many underground tunnels and chambers which linked the furnace bases back to the main engine houses.

By buttressing the supporting scaffolding back onto the old furnace bases, and utilising heavy concrete blocks as kentledge, sufficient dead weight was applied to stabilise the temporary propping. Prior strengthening of the furnace bases was required to ensure that the high loads from the buttresses could be transferred to the sub-strata without distressing the superstructure.

Following completion of the propping scheme a detailed visual and photographic inspection of the site structures was undertaken to ascertain and record the condition of the walls and to determine, the cause of the damage, enabling the formulation of a repair and stabilisation strategy. This appraisal concluded that the damage which had occurred could be generally summarised as follows:

- ◆ Superficial damage of the masonry and stone walls caused by the presence of vegetation and water

ingress. This was most evident at the top of the structure, where significant loosening of the brick and stonework had occurred with subsequent loss of the retained

material. Water penetration, in conjunction with frost action, was also causing significant deterioration to the fabric of the brickwork and stonework.

- ◆ Differential settlement in the south wall of the south furnace charging building resulting in westward rotation of part of the wall and consequent vertical and diagonal cracking through the superstructure supported by it.

- ◆ Cracking and spreading movements in the superstructure, resulting in outward displacement of walls.

- ◆ Distress cracking, loss of material and localised collapse of the stone masonry retaining walls which where up to 13 m high.

The geology of the retained ground was investigated, using shell and auger holes with subsequent laboratory tests to determine the characteristics of the subsoils. The investigation concluded that the site is overlain with topsoil on fill materials from 6 - 11 m deep. The fill is principally ash containing one or more of brick and tile discards, blast furnace slag and coal. It is deposited on mudstones containing strata or lenses of sandstone and hard clay. The mudstone at the fill interface is frequently softened to a medium clay due to weathering caused by the presence of ground water.

Rates of deformation and crack development

Since the excavation of the structure in 1980, a number of structural movements appear to have taken place, as evidenced by cracking and distortion of early repairs undertaken by the Ironbridge Gorge Museum Trust. No long term records exist, but during the preparation of reports for the repairs brief, it was visibly noticeable that movement and cracking was worsening, confirming that it was progressive.

In addition to this cracking, rusting of the cast and wrought iron plates, lintels and tie bars within the structure was continuing, due to the ingress of ground water, with a consequent splitting and heaving of masonry. This in turn caused increased water penetration to the structure.

Remedial measures

Following detailed discussions with English Heritage a series of remedial measures to stabilise the structures was proposed. This work included the general consolidation of voided and eroded brickwork and stonework in conjunction with the installation of new tie bars and ground anchors. The selection of the ground anchor and tie bar was the subject of careful consid-

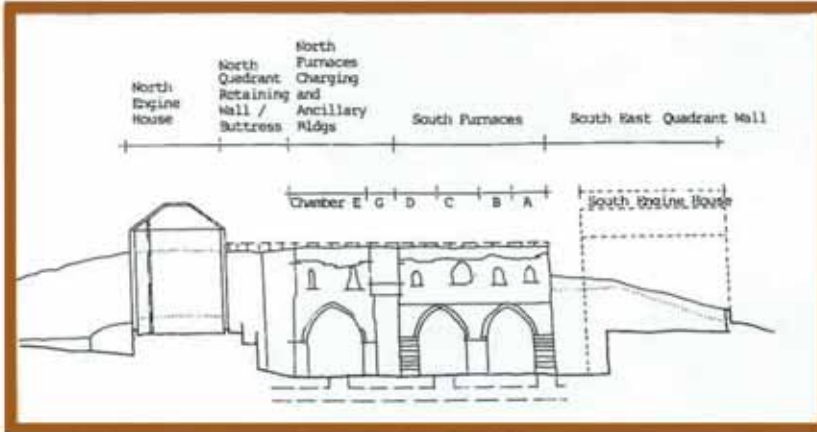

West elevation.

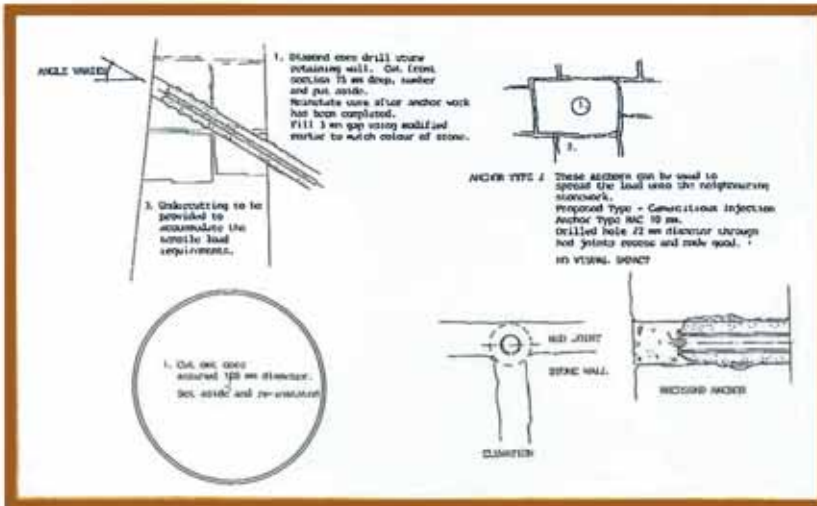

Making good anchor holes in stonework.

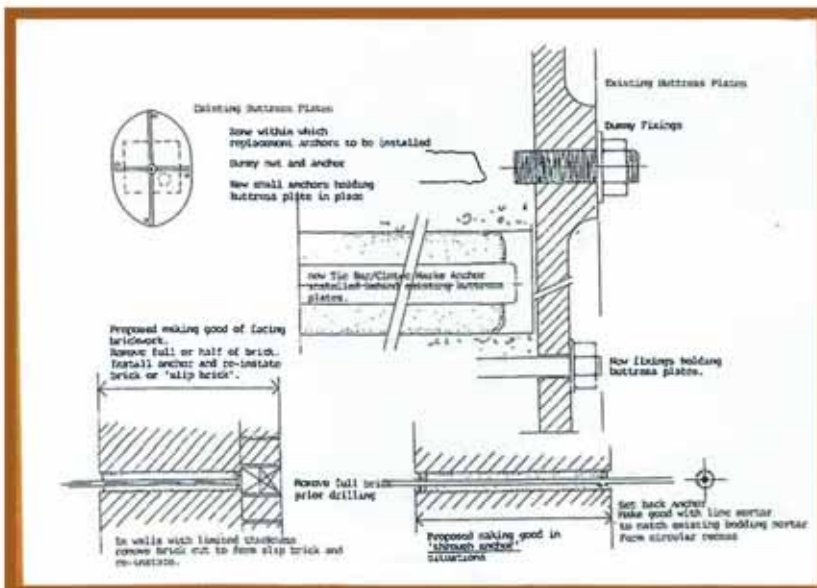

Making good anchor holes in brickwork.

archaeological and historical importance of the structure.

Concern was expressed that any grout used in the anchoring works should not be allowed to penetrate areas of the structure in an uncontrolled fashion. Many anchor types and systems were reviewed, but the Cintec Harke Anchor, manufactured by Cavity Lock Systems Limited, was finally adopted. This provided not only the correct structural solution to the problems but also enabled the work to be undertaken in a controlled manner, with the grout restricted to only those areas around the anchors where it was structurally required.

The Cintec Harke anchors were used to replace the eroded and rusted tie bars, in addition to their use for the ground anchorage work on the project.

Careful consideration and planning was undertaken by the design team in conjunction with the specialist sub-contractor so that the all the anchors and ties were installed with minimal visual disturbance to the building structure, not only during installation but also upon completion of the work. The ground anchors were required to sustain a maximum safe working load of 60 kN and this was achieved by socketing the Cintec Anchors a minimum of 3.0 m into the mudstone strata.

The ground anchor installation required a 100 mm diameter core to be taken out of the centre of a selected stone within the retaining wall. Drilling was then undertaken with or without a steel casing, using an air flush drilling system, to a designed anchor position and length of embedment into the underlying mudstone. The anchors were installed at a downward angle in order to reduce the depth of drilling necessary to penetrate the mudstone. Even with this angular adjustment the length of the Cintec Anchors was in excess of 20 m. The Cintec anchor was then inserted in the hole with the sock positioned around the anchor. The whole anchor was then pressure grouted to within 100 mm of the face of the wall. Finally the original core was refitted into the core hole and resined into position so as to mask the end of the anchor.

Where necessary, due to the location of the anchor within the wall and the adjacent stones, the insertion of small diameter stainless steel needles, secured by epoxy resin was undertaken. This 'stitched' the area around the anchor together. Generally a Cintec RAC 10 mm diameter anchor was employed with the anchors positioned into the bed joints of the stone retaining wall. In

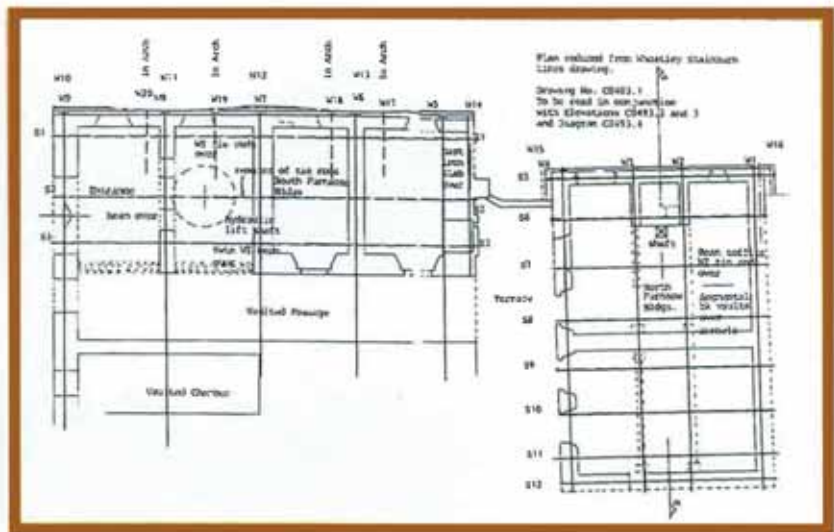

Setting out anchor/tie bars.

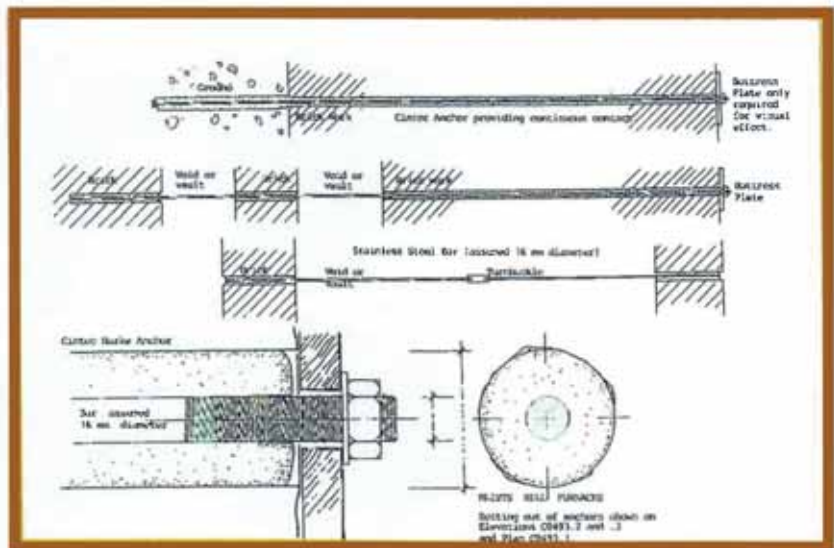

Application of tie bar system with Cintec Harke anchors covering the south and north furnaces and north engine house.

most cases 5 Cintec RAC anchors were installed around each ground anchor position.

Within the south and north furnaces where vault tie bars were to be replaced, the use of the Cintec Harke anchors was once again adopted.

The new ties were inserted adjacent to the locations of the existing tie bars with the existing patress plates initially removed to enable drilling to take place.

The anchors were installed in 50 mm diameter holes cored through the brickwork and where necessary into the mudstone strata behind the structure. The anchors and socks were inserted and grouted within the brickwork/mudstone, leaving the exposed areas of tie bar clear of any grout.

The existing patress plates were re-fixed in their existing position so as to mask the repair works and leave

the structural appearance of the building apparently unaltered.

Conclusions

The use of the Cintec Harke sleeved anchors has enabled the stabilisation and renovation of this very important archaeological and historical structure to be achieved. The anchors were able to satisfy the necessary structural criteria whilst enabling all the operations to be fully controlled thus producing only a nominal visual and archaeological impact on the structure which remained apparently unaltered.

Acknowledgments

1. The Ironbridge Gorge Museum Trust Archaeological Unit
2. W.T. Specialist Contracts Limited Sub-Contractor
3. Weaver Construction Limited Main Contractor
4. Wheatley Taylor Stainburn Lines Architects



Holy Austin Rock - Kniver, Staffs, England, UK



Restoration of the lower cave dwellings at Holy Austin Rock, Kniver Edge

The name 'Holy Austin' is said to be after a hermit who lived near the site during the 16th century. This is the earliest known reference to the occupation at Holy Austin rock.

In May 1993 the National Trust completed the first phase of restoration in their imaginative scheme to restore the nationally important cave dwellings at Kinver Edge, Staffordshire. Since the rock houses were cleared of their last occupants, as late as the 1950's, the rock structures had deteriorated and several of the caves within the three-level complex of up to a dozen separate dwellings had become dangerous. In 1990, the Trust took a bold decision to re-build the upper rock houses and to bring the interior up to modern standards for a Custodian to control the area immediately around Holy Austin Rock.

The Lower Caves were still a serious structural concern. They had been crudely bricked up by the local Council in the 1950's for public safety, as there had been extensive rock falls from the ceiling of the large central cave – an amazing tunnel known in later years as the Ballroom.

With the financial support of the local Management Committee, the national Trust once again commissioned the Architect for work to secure the Lower Caves, and also to restore the facades and one or two of the rooms to their original design.

The unstable condition of the soft red Permian sandstone required careful and often dangerous work inside the caves by the Contractor, G T Wall and Sons of Stourbridge, to secure the falling ceiling slabs.



External view of main entrance to restored dwelling.



Internal view of front room, above cave.

A major structural defect, resulting from the internal failures, was the large vertical fissure and associated cracks, just behind the eastern façade, which had widened in recent years due to weathering and root penetration. The structural Engineers, Ascough and Associates, say the danger of the whole façade falling outwards, as a 1 m thick slab, and it was decided to use modern rock bolting techniques to anchor this slab back to the stabilized rock including the new foam concrete fill, just above cave ceiling level.

The drilling and grouting of the rock anchors was carried out by A.P.B. Group Limited of Stoke-on-Trent in August 1997. The Specification was for 5 Cintec rock anchors 3-4m long, and 20mm diameter, 316 grade stainless steel rebar. The anchors were grouted into 40mm – 50mm diameter holes drilled with air flush rotary rock drills. In addition to the main rock bolts, several more ceiling bolts were installed under the Engineer's direction using 16mm diameter anchors of varying lengths.

The Lower Caves were completed in November 1997 and the National Trust has now raised the status of the caves giving them a detailed entry in the National Trust handbook.



Adjacent caves in unrestored condition.



Roof bolt support to ballroom ceiling.



The completed row of cave dwellings ready for occupancy.

Obj. Wülzburg

- 5 -

STÜTZWAND SCHNITT

TEILANSICHT

Darstellung
unmaßstäblich

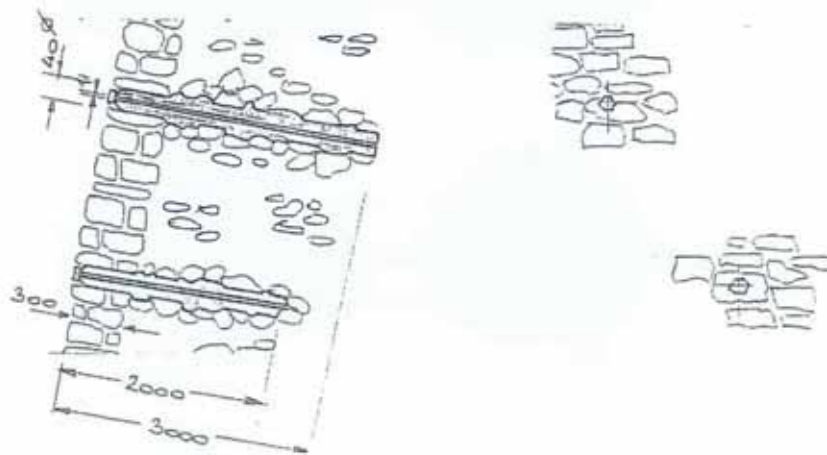

SCHNITT durch STANDARDANKER System C=INTEC-MC



SCHNITT durch DOPPELROHRANKER System C=INTEC-MC
Ausführung RAC 10 X 1 mm.



CINTEC tools, stitching anchor installation & injection



Corner, drilling for small stitching anchors, Grout mix



Other corner during repair works



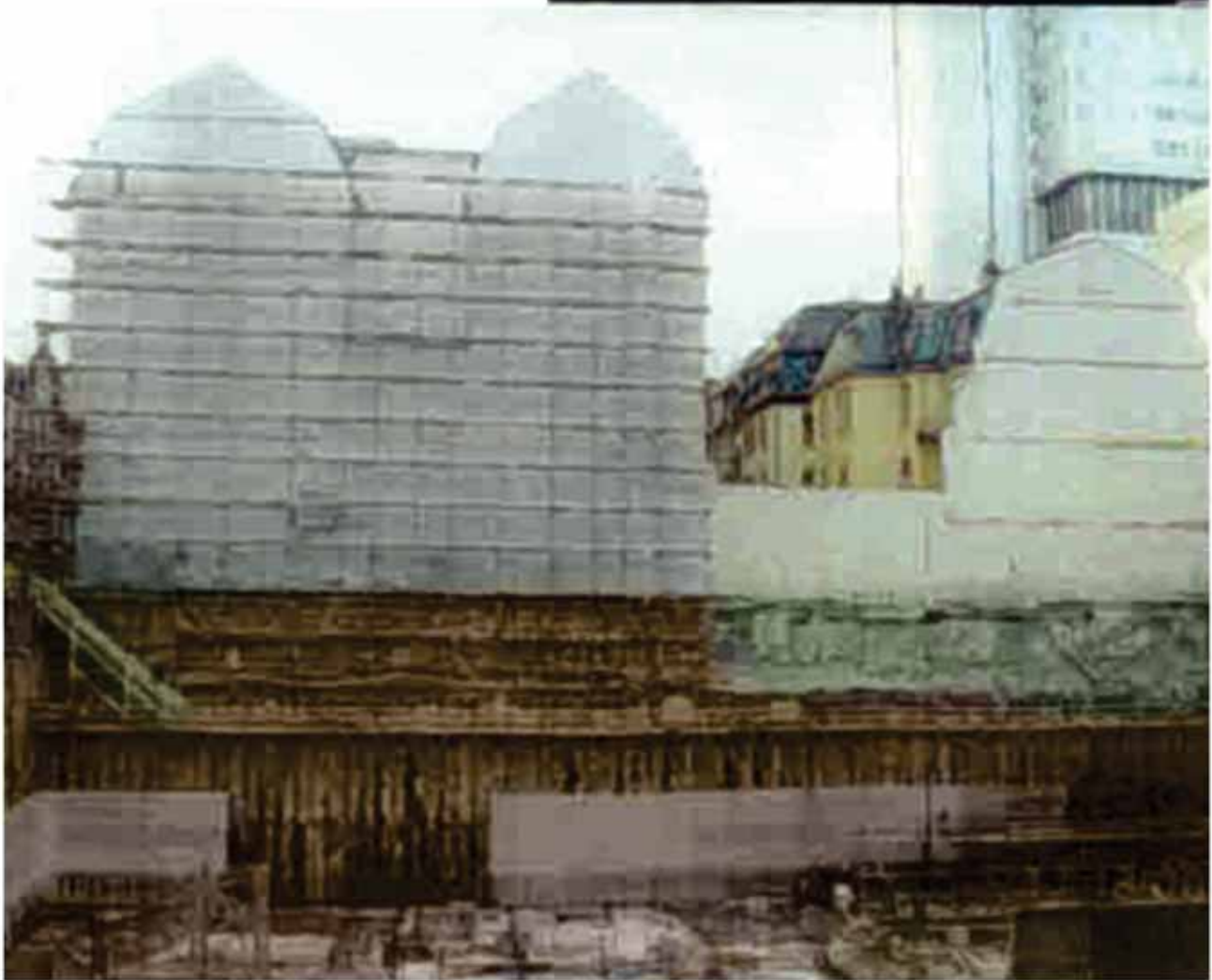

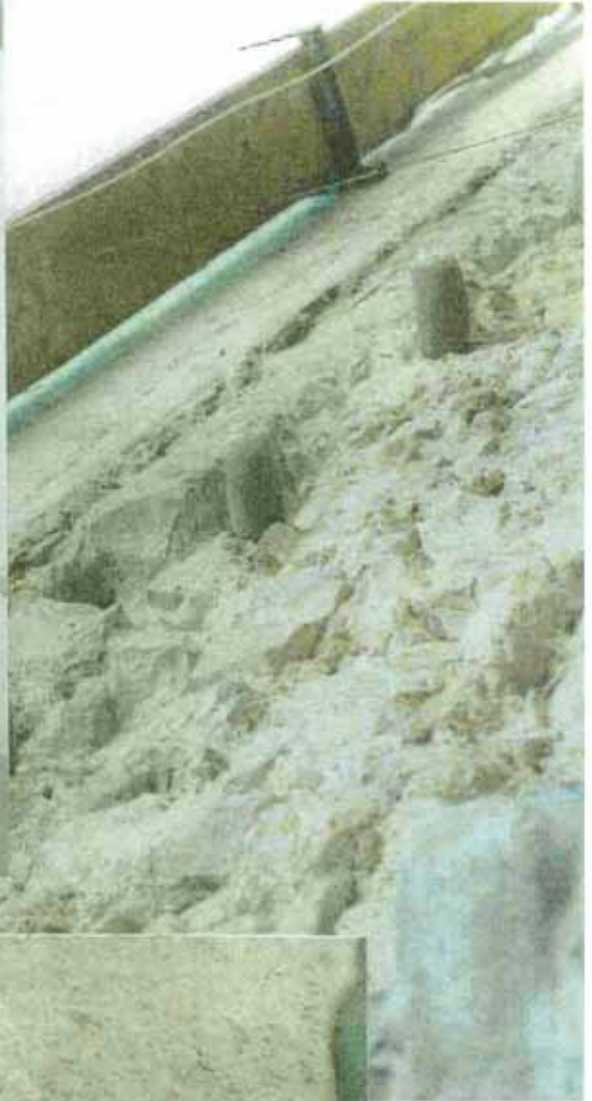
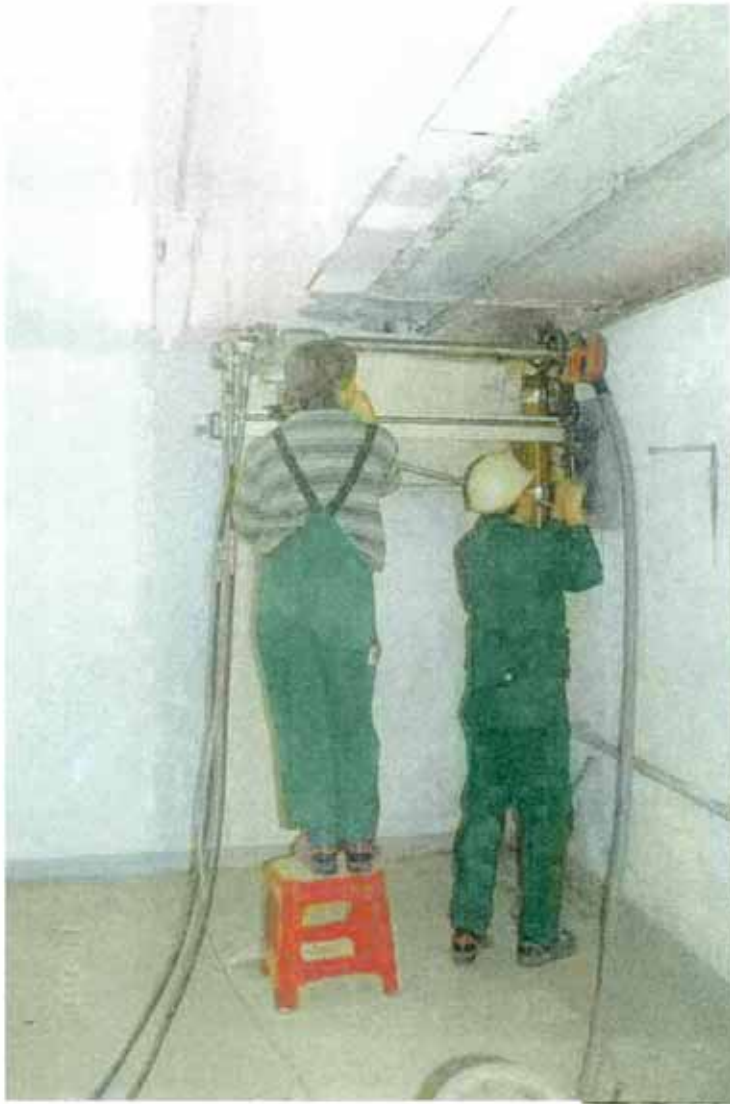

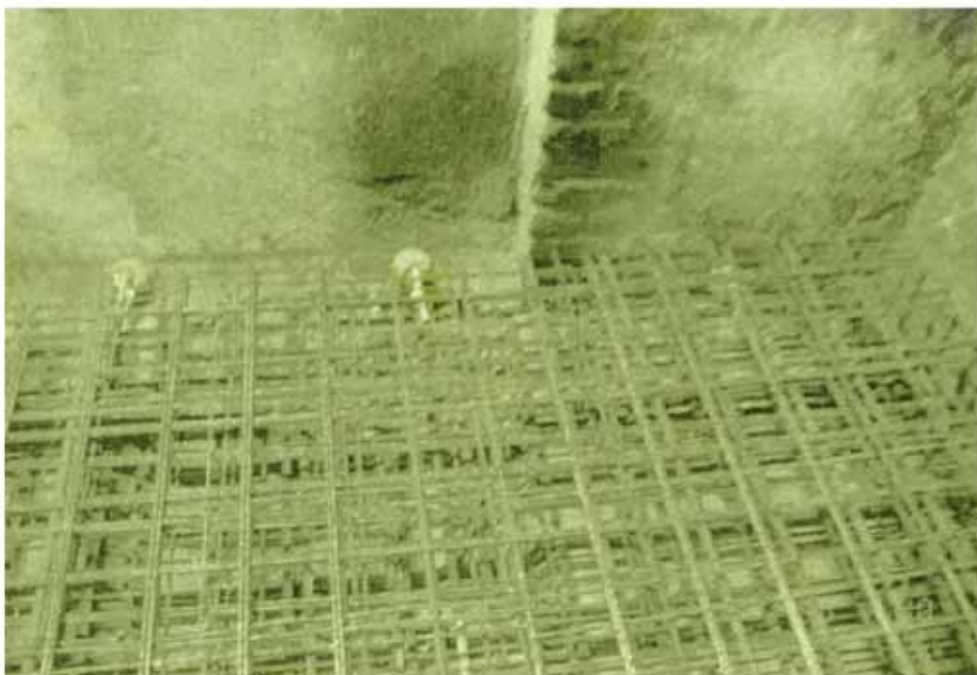



PARAPET WALL STRENGTHENING FROM CINTEC

No two masonry arch bridges are the same, and this also applies to their parapet walls. The requirements specified for individual walls can differ considerably and must reconcile a variety of needs. These may include impact containment, vehicle redirection, the protection of others in the vicinity, compatibility with the masonry structure as a whole, as well as the visual appearance of the strengthening solution implemented.

The Cintec Anchor System provides a highly versatile method of internal structural reinforcement that is tailored to meet the specific requirements of each parapet wall. This service, known as Paratec is backed by extensive research and development, this includes advanced computer modelling, practical testing and also the experience built up from numerous strengthening projects. The Paratec system can strengthen a masonry wall while remaining sensitive to the original architecture and without any narrowing of the road way.

The Anchor: The system comprises a steel bar enclosed in a mesh fabric sleeve, into this a highly specialised grout is injected under low pressure. This is a Portland cement based product, containing graded aggregates and other constituents which, when mixed with water, produce a pumpable cementitious grout that exhibits good strength without shrinkage. Installation is by precisely drilled holes using wet or dry diamond coring technology. The flexible sleeve of woven polyester restrains the grout flow and expands up to twice its original diameter moulding itself into the shapes and spaces within the walls. This provides a strong mechanical bond along the entire length of the anchor dispensing with the need for external anchor plates.

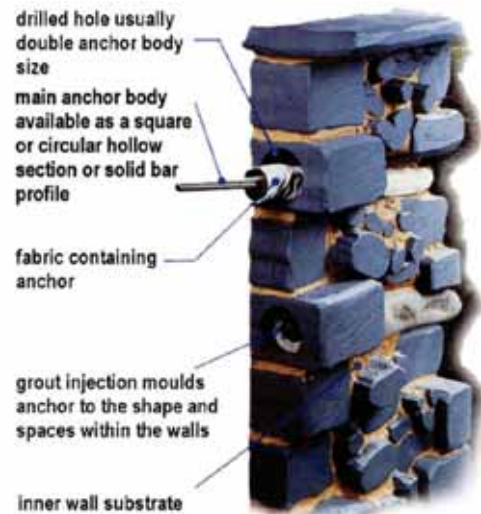

The size and type of steel anchor, the strength of grout and the diameter of the hole can all be varied to the required design parameters, these will include providing the appropriate stiffness compatible with the masonry.



Research & Development

The comprehensive service offered by Paratec include advanced computer modelling techniques that simulate the effects of a vehicle impact upon a specified masonry wall. Working in conjunction with both software specialists and consulting engineers, Paratec utilises an advanced dynamic software incorporating a discrete element analysis technique that enables the behaviour of parapet walls to be accurately predicted under various circumstances.

Practical Testing: Tyne-Tees University



Dynamic full-scale parapet wall tests were undertaken in the heavy structures laboratory at Tyne-Tees University. The tests clearly demonstrate the robustness of parapet walls reinforced with Cintec masonry anchors. The walls were impact loaded using a falling weight test rig designed to generate the force/time history of an actual vehicle impact test that had previously been recorded and analysed at MIRA.

In this test, the Cintec reinforcement used was a 19.5 metre high yield MS multibar anchor comprising six individual stainless steel bars of 8mm in diameter. This was installed 370mm below the top of the wall.

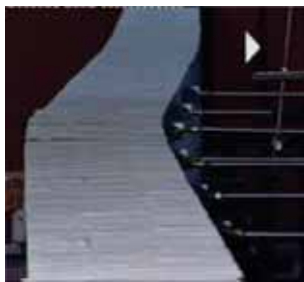

Raking anchors were also installed in pairs at 30° to the vertical. These were 1 metre long 3 strand 8mm diameter multibar anchors encapsulated in a 40mm diameter sock and installed in a 50mm diameter hole.

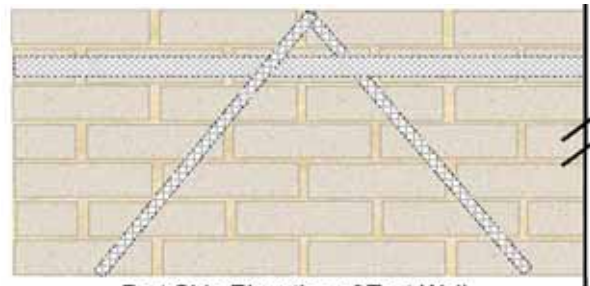

Part Side Elevation of Test Wall

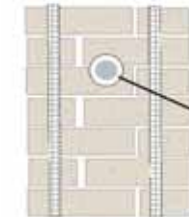

Wall End Elevation

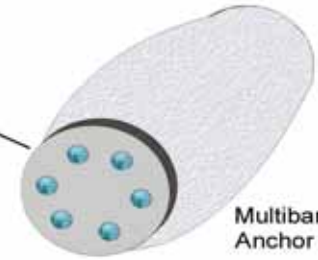

Multibar Anchor



Although the bridge was shunted by the force of the impact, it remained intact with no significant spalling. The picture above shows the wall face opposite to the point of impact after two consecutive tests.

London Underground



Post-tensioning Cintec anchor in test panel.

Two 16mm diameter 2 stage anchors were installed vertically, the anchorage length within the supporting structure was then inflated and left to fully harden. The anchor was then tensioned and the second sock occupying the remaining space in the masonry wall was inflated.

London Underground has a great many brick walls and parapets supported on elevated structures. As it is the world's oldest underground system, many of the walls are between 100 and 150 years old and are consequently suffering from a degradation of the mortar which is invariably lime based.

An insitu load test was carried out in order to demonstrate the applicability of Cintec anchors for both stabilising these structures and for strengthening them against dynamic air pressure loading. The test was also used to confirm that the performance of the strengthened wall had been correctly calculated and thus provide assurance of the methodology.

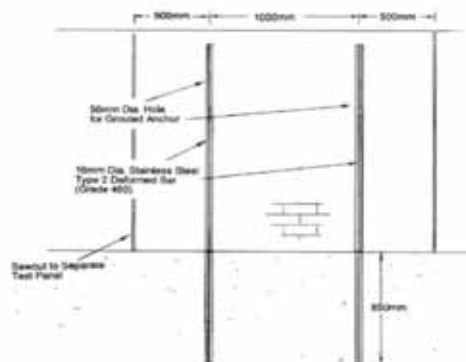

Details of test panel strengthening scheme.

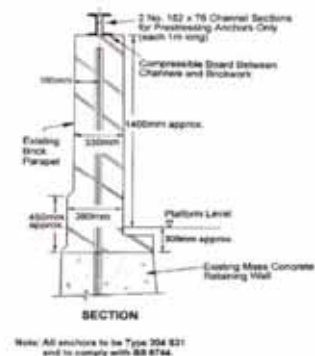

Note: All anchors to be Type 204 S21 and to comply with BS 8716.

Once the anchors were cured, an applied wind loading was simulated by the application of a lateral point load on a horizontal spreader beam positioned at the walls centre. An incremental lateral load up to 3.5kN/m was applied by a hydraulic jack which demonstrated a linear elastic response.

The predicted response, calculated beforehand and based on assumed values for the material properties, was within 30% of the measured values. Bearing in mind the wide range of uncertainties in relation to the wall stiffness and strength, this demonstrated an adequately high level of accuracy. On completion of the test, no cracking or spalling was observed. It was concluded that the strengthening scheme presented

both “an economic and aesthetic solution to the refurbishment of understrength and unstable masonry parapets”.



CASE HISTORY - INCLINED PLANE BRIDGE, COALPORT



Spanning the river Sever at Coalport in Shropshire, the Inclined Plane bridge is a registered ancient monument and as such, any alteration to its appearance is unacceptable. The Archtec method of bridge reinforcement was chosen to increase the load bearing capacity of the structure, and a need was also recognised to strengthen its parapet walls.

A solution was achieved by the installation of Cintec 16mm studding anchors, of between 1.5 and 3 metres in length. These were designed with two individually inflated socks and were installed vertically at 1 metre intervals through the parapet walls and into the barrel of the arch. The lower (arch barrel) sock was then inflated and left to cure. The second sock was then inflated and placed under a tension of 10kN by using a tensioning plate. The grout was then cured and the tensioning plate removed.

Finally the sandstone parapet coping stones were replaced and two missing stones reproduced. The solution provided the necessary increase in wall strength without having any visible change to its appearance.

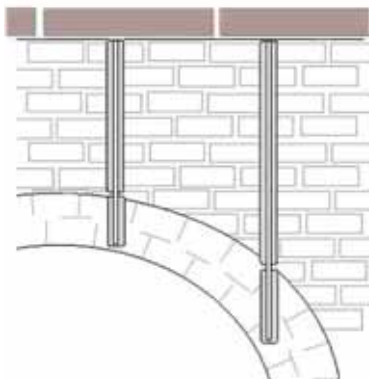

CASE HISTORY - WALCOT ROAD BRIDGE, TELFORD



Built in limestone and spanning the river Tern, Walcot Road bridge is an historic structure with a grade II listing. As it was constructed long before the development of motorised traffic, it is vulnerable to the modern demands placed upon it. The narrow roadway has led to numerous collisions and scrapes along its parapet walls for which Wrekin Council had correspondingly undertaken various stonework repairs. It was decided to pre-empt future repair work with a parapet reinforcement scheme. Cintec provided a solution that met both the engineering and aesthetic requirements.



With the use of non-percussive diamond core drilling, thirty-six prestressed Cintec anchors of between 1.4m and 2.8m in length were installed vertically through the parapet walls and into the arch barrel. Core drilled sections of the monolithic coping stones were then replaced and grouted into the entrance of the anchor holes to provide an almost invisible finish.



Current research is focusing on the development of articulated anchor reinforcements. These are designed to fail progressively in order to absorb the energy of a vehicle impact while at the same time reducing the structural damage incurred by the bridge.

SECTION 4

PART - 2

WATER RETAINING STRUCTURES

&

CASE HISTORIES



Hydro-Electric Dam repairs Nigeria



*Georgia-Power Bartletts ferry dam,
Athens, Georgia, USA*



CANAL WALLS



HARBOUR WALLS

Harbour Wall Ground Anchoring

Strengthening of Zeebrugge Harbour Wall (Belgium)

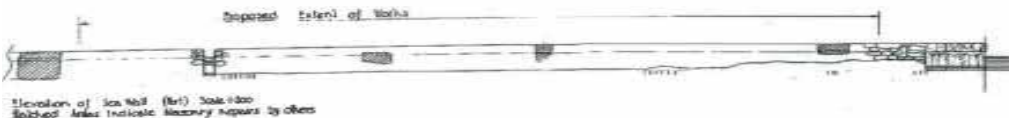
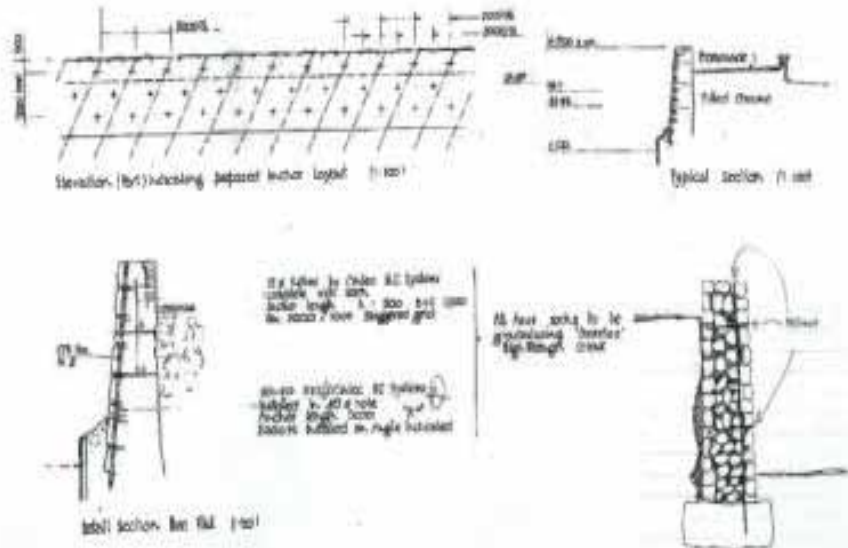
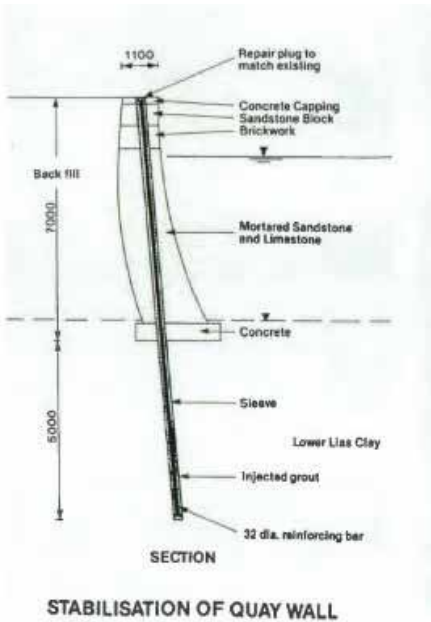

Marco Island Sea Wall - Florida USA

(An early example of Cintec Ground Anchoring 1983)

March 1983 - Following a move from Germany to a new home on a Florida island, Civil Engineer Paul Pella was faced with a structural problem common to the region – subsidence and dislocation of the protective sea walls surrounding the homes built upon the island. Fortunately for Mr. Pella, his engineering experiences back in Europe provided him with an innovative new technology ideally suited for stabilizing these concrete structures – Cintec Anchors. The ground behind the walls consists essentially of sand, not considered an ideal medium for any form of anchorage. However the adaptability and unique features of the Cintec system overcame any potential difficulties associated with this soil type.

Consisting of a steel rod enclosed in a mesh fabric sleeve, the principle of the system is to inject a specially developed cementitious grout into the restraining sleeve of the anchor and so inflate it along its entire length. As well as providing an extremely strong mechanical bond, some liquid or 'grout milk' passes through the material membrane and bonds with the original substrate beyond.



In the case of Marco Island, an additional wide section of expandable sleeve, or sock as it is often called, was attached to the far end of the anchor. When the grout was injected, the additional section expanded to a diameter greater than the rest of the anchor. This created a bulb deep within the soil and ensured a truly secure point of anchorage.



As can be seen in the images (right) the individual boreholes were produced by diamond core drilling, in this case with a core diameter of 65mm (2 ½") and to the length of the anchor : 3.2 meters (15ft) – Fig 1. The anchors were then installed with a plastic half pipe to facilitate their insertion – Fig 2. Finally the anchors were injected with 'presstec' cementitious grout expanding them from their far end to the front. Although not essential, a flange – plate was also screwed to the exposed anchor end for additional securement – Fig 3.



PORT DE QUEBEC



The Port of Quebec (French: Port de Québec) is an inland port located in Quebec City, Quebec, Canada. It is the oldest port in Quebec after the Port of Montreal.

Owned by the Government of Canada and operated by the Quebec Port Authority, the port has been in existence since the early 17th Century.

In the 19th century, the Port of Quebec was one of the most important in the world. It played a major role in the development of both the city and of Canada. In 1863, more than 1,600 ships went through the port, transporting almost 25,000 sailors. It was during this era that the shipbuilding industry grew considerably in Quebec City.

In the 20th century, the dredging of the Saint Lawrence River between Quebec City and Montreal moved major port activities upstream. Today cruise traffic has replaced much of the former freight traffic.



In the summer of 2019 Cintec was contacted by Jhon Páez, Senior Structural Engineer Ports, Marine and Coastal of WSP Global Inc – an international engineering firm with over 50,000 employees in some 500 offices serving in 40 countries worldwide.

The requirement was for vertical strengthening in two areas of Quai 5-14N of the Port of Quebec as shown in top photos. As determined, anchors were to be a 1 1/4" diameter, #30M 2205 stainless steel reinforcing bar with overall anchor lengths of 25 feet (7.5M) to 30 feet (9 M) long. 48 anchors were fitted with 4 inch (100 mm) sock and installed by use of a crane in drilled cored holes of matching diameter. Placement completed by injection of Presstec © grout.



Cintec anchors in protective shipping tubes



Cintec anchors hoisted into place by crane



Cintec anchors being placed by installer



Cintec anchors in place prior to inflation

The strengthening of heritage marine structures in Jersey with needling technology



Above North Pier and below St Aubin's Fort.

The three structures are the North Pier and South Pier of St. Aubin's Harbour and the St. Aubin's Fort Breakwater. Both structures are exposed to waves from the south west and act as breakwaters.

In 2001 the North Pier was assessed as being in a state of instability due to movement of its internal wall and apparent settlement of the interior of the pier .

Large cracks had developed and could be seen in the asphalt surfacing indicating a threat of impending wedge failure of a section of the inner wall.



St Aubin's Fort Breakwater has in turn suffered a re-occurrence of masonry movements and loss of pointing at its inner, lower deck wall. In 2008 a bulge was also identified in part of this inner wall which prompted concerns about this part of the breakwater's structural integrity.

The States of Jersey Planning and Heritage Departments, who asked for a 'tying in place' solution to be investigated for stabilising the inner wall. Environmental concerns regarding the endangered mollusc species further reinforced this argument.

The chosen 'stitching' solution used Cintec anchors consisting of a number of solid stainless bars grout that seeps through the fabric sock used in the anchor between the masonry and the reinforced anchor is very high tying areas of loose masonry blocks together. This 'stitching' methodology was also able to provide a foundation solution; the numerous small diameter vertical anchors become mini piles when drilled down through the granite wall stones, through the beach deposit and into the Jersey

rock shale beneath. The natural arching of the To resist the inner wall overturning, after pinning the base of the wall with vertical mini piles, requires a form of top restraint in the outward direction. The final design consisted of horizontal 'passive' ties from the inner wall to the outer face although inclined raking anchors through the core of the Pier tied into the Jersey rock shale were also considered.

The 'stitching' anchor solution provided clear benefits allowing the structure to be anchored and stitched together without changing its character and with minimal impact. The number and spacing of anchors, was optimised to satisfy the onerous load criteria imposed by the sea conditions in such

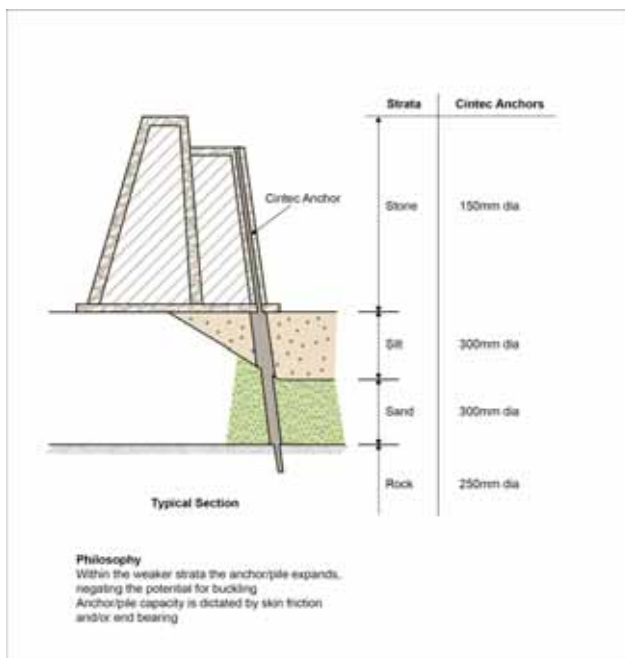

The strengthening of heritage marine structures in Jersey with needling technology

REV 2 MARCH 2021



Anchors with coupler



Pre-injection with masking tape



Anchor grouted & expanded

Horizontal ties were inserted through the inner wall of the main breakwater so that the inside face wall of the lower deck was not only tied to the inner bulk of the original wall but also had additional cantilevered 'beam' support.

Not only did the final design solution comply with the planning authority requirements, it furthermore mitigated pollution control concerns by the 'sock' principle of the anchor system where the grout is contained within a small radius of the sock diameter.



At the North Pier the vertical drilling works for the anchors took place through the inner wall concrete up-stand used for vessel mooring. Plugs in the masonry were reinserted to enable invisible fix once the anchor had been installed.

Another valuable aspect of the installation process was that each individual anchor drilling provided its own borehole information. This allowed the length of the anchor to be reduced where, for example, the rock outcrop was found to be at a shallower depth.

From a large machine platform aided by localised, demountable scaffolding the horizontal anchors were drilled and fixed. The number of verticals and horizontals at the inner wall of the Fort Breakwater required careful setting out to avoid conflicts and also to allow for flexibility with respect to deck positioning of the rig on the structure.

The 'stitching' method used to stabilise and strengthen these two marine heritage structures has proved to be effective on a number of fronts. The 'secret' or 'hidden' fix of the structure means that the heritage planning aspects of the strengthening works are achieved. Economically, the costs budgeted for the original rebuilding of the inner wall of the North Pier on a new foundation, were of a similar magnitude to that for the 'stitching' techniques. There is a certainty with respect to the capacity of each anchor or mini pile as the drilling technique means that every element's bearing capacity is known and recorded.

Hay's Dock Lerwick (Shetland Islands) - Scotland

Lerwick is the capital of the Shetland Islands and in the early 1830's became a thriving centre for the herring industry. The foundation for this commercial success lay with the construction of Hay's Dock and a complex of warehouses and curing yards together with all the facilities for building and rigging sailing vessels. The fortunes of the herring industry fluctuated considerably during the 19th century and as vessels became larger and steam power became the norm, a new larger facility was required and subsequently built by the Lerwick Harbor Trust in 1906. The original dock continued to play an important commercial role adapting primarily to the timber trade.



Panorama of Hay's Dock with the Heritage Centre under construction in the background (right), the restoration of the old sail house on the quay (centre right) and Cintec stabilisation work (end of the quay left of sail house).

Today Hay's Dock stands as a monument to the town's industrial heritage and with the assistance of the Shetland Amenity Trust, Historic Scotland and a contribution of lottery funding, the dock area is being rejuvenated with the construction of the new Shetland Museum and Archives building as well as the refurbishment of the old docks itself.

When originally constructed, technology for building underwater was limited. Consequently the foundations of the furthest and hence deepest part of the quay consist of large stone blocks resting upon a layer of relatively unstable sand and gravel. Inevitably, over the last two centuries, the structure has suffered from significant subsidence.

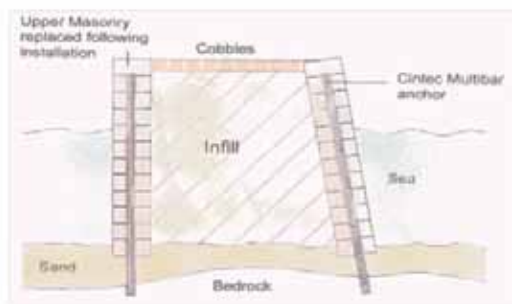

Consulting Engineers Elliott & Company proposed a solution for installing Cintec anchors to both secure the individual blocks of stone masonry and also to underpin the whole structure to the bedrock below. 18 Cintec Multibar anchors were installed by the drilling contractor Holequest Ltd, each anchor being five meters long and consisting of four strands of 16mm diameter 316 high grade stainless steel rebar in square formation. A drill rig was used to diamond bore each 150mm diameter hole prior to the installation of the multibar anchors. The two man cycle of drilling and installation proceeded at a rate of one anchor extremely variable weather even in the month of June.



High grade stainless steel was chosen to improve the long term resistance to the corrosive effects of the salt water. Before installation, the polyester sock of each anchor was completely saturated in fresh water, not only to facilitate the injection and inflation of the anchor, but also to provide a temporary barrier between the reinforcing bars and the external sea water. The low pressure injection of the cementitious grout expanded the anchors from the far bedrock end upwards and so displaced any sea water within the drilled holes and locking the anchors were installed, the original surface edge stones and inner cobbles were placed back into position, concealing the stabilisation work beneath.

A mobile rig was employed firstly to core drill the anchor holes, then to temporarily install a metal tube hole lining, following by the lifting and lowering of the Cintec anchor (side) and finally the removal of the temporary core lining prior to anchor injection.



Lock Gates Clarendon Docks, Belfast, U.K.



Cintec anchors have been used to fix two 20 ton lock gates, as part of the 750 million pounds sterling, regeneration of Belfast's Laganside Development.

Clarendon Docks, where shipbuilding in Belfast first commenced, was severely affected by the river's tidal range. Construction of a temporary dam across the existing dock basin, and installation of a lock between the basin and the river, has created an aesthetically pleasing non-tidal water feature capable of facilitating small craft. Although the dock basin was pumped dry for the refurbishment of the waterfront site, it was vital that the fixing method selected was suitable for use underwater.

Each gate is supported by two hinges bolted into the 600mm concrete wall of the lock. One of the key reasons for selecting the Cintec system, was that although the top hinge for each gate is well above the water level, the lower hinge falls within the tidal zone, "explained Brian Campbell. Design engineer for the installers. During the installation, sea-water poured through at one of the anchor locations. We were concerned that alternative fixing methods would not be as successful in such wet conditions."

Following extensive testing, 48 Cintec anchors were embedded into the wall to support the two lock gates. Each lower hinge required 12 fixing anchors, 450mm in length and 102mm in diameter at 200 and 220 centers. The installation of the anchor bolts at the lock gates has been undertaken by ACE Fixings, the approved installers of Cintec anchoring system for Ireland.



CINTEC REINFORCEMENT SYSTEMS

Tel 1-613-225-3381
1-410-761-0765
Fax 1-613 224-9042

E mail solutions@cintec.com

www.cintec.com

