

A single copy of this document is licensed to

On

This is an uncontrolled copy. Ensure use of the most current version of the document by searching the Construction Information Service.

## Design Manual for Roads and Bridges



Highway Structures & Bridges  
Inspection & Assessment

# CS 454

## Assessment of highway bridges and structures

(formerly BD 21/01)

Revision 0

### Summary

The use of this document enables the structural safety and serviceability of highway bridges and structures to be assessed, providing key information that is required to manage risks and maintain a safe and operational network.

### Application by Overseeing Organisations

Any specific requirements for Overseeing Organisations alternative or supplementary to those given in this document are given in National Application Annexes to this document.

### Feedback and Enquiries

Users of this document are encouraged to raise any enquiries and/or provide feedback on the content and usage of this document to the dedicated Highways England team. The email address for all enquiries and feedback is: [Standards\\_Enquiries@highwaysengland.co.uk](mailto:Standards_Enquiries@highwaysengland.co.uk)

**This is a controlled document.**

# Contents

<b>Release notes</b>	<b>4</b>
<b>Foreword</b>	<b>5</b>
Publishing information . . . . .	5
Contractual and legal considerations . . . . .	5
<b>Introduction</b>	<b>6</b>
Background . . . . .	6
Assumptions made in the preparation of the document . . . . .	6
<b>Abbreviations and symbols</b>	<b>7</b>
<b>Terms and definitions</b>	<b>9</b>
<b>1. Scope</b>	<b>12</b>
Aspects covered . . . . .	12
Implementation . . . . .	12
Use of GG 101 . . . . .	12
<b>2. Assessment processes</b>	<b>13</b>
General . . . . .	13
Structural review . . . . .	13
Inspection for assessment . . . . .	13
Inspection for assessment of steel and wrought iron bridges, concrete bridges and steel composite bridges . . . . .	14
Inspection for assessment of masonry arch bridges . . . . .	14
Inspection for assessment of buried structures, sub-structures, foundations, retaining walls, wing walls and dry-stone walls . . . . .	15
Road surface category . . . . .	15
Assessment . . . . .	16
Definition of the scope of the assessment . . . . .	16
Carrying out the assessment . . . . .	17
Reporting the assessment . . . . .	17
Management of substandard structures . . . . .	18
<b>3. Basis of assessment</b>	<b>19</b>
Method of assessment . . . . .	19
Limit states . . . . .	19
Assessment actions . . . . .	19
Assessment action effects . . . . .	20
Assessment resistance . . . . .	20
Verification . . . . .	21
<b>4. Properties of materials</b>	<b>22</b>
Unit weights, elastic moduli and coefficients of linear thermal expansion . . . . .	22
Strengths of materials . . . . .	23
<b>5. Assessment actions</b>	<b>25</b>
General . . . . .	25
Dead load and superimposed dead load . . . . .	25
Carriageway traffic loading . . . . .	25
ALL model 1 . . . . .	27
ALL model 2 . . . . .	28
Combined uniform and knife-edge load . . . . .	28
Single axle loading . . . . .	36
Centrifugal effects . . . . .	37

Accidental vehicle loading . . . . .	40
Footway loading . . . . .	41
Pedestrian ALL model . . . . .	41
Wind actions . . . . .	42
Thermal actions . . . . .	42
Longitudinal traffic loading . . . . .	42
<b>6. Structural analysis</b>	<b>44</b>
Analysis methods . . . . .	44
Effective spans . . . . .	44
Dispersal of loads for decks other than troughs . . . . .	44
Dispersal and distribution of loads through trough decks . . . . .	45
General . . . . .	45
Loads for longitudinal trough decks . . . . .	45
Loads for transverse trough decks . . . . .	46
Dispersal and distribution of loads in trough decks . . . . .	46
<b>7. Assessment of masonry arches</b>	<b>49</b>
Limit state verifications for masonry arches . . . . .	49
Application of actions for masonry arch assessment . . . . .	49
Material partial factor and condition factor for masonry arches . . . . .	51
Analysis of masonry arches . . . . .	53
Mechanism analyses . . . . .	55
Equilibrium-based analysis . . . . .	55
Non-linear finite element analysis . . . . .	55
The modified MEXE method . . . . .	56
<b>8. Assessment of cast iron</b>	<b>57</b>
Permissible stresses in cast iron . . . . .	58
<b>9. Normative References</b>	<b>60</b>
<b>10. Informative References</b>	<b>61</b>
<b>Appendix A. Partial factors for actions</b>	<b>63</b>
<b>Appendix B. Vehicle load models</b>	<b>66</b>
B1 Vehicle load models for normal and restricted loading levels . . . . .	66
<b>Appendix C. HB Vehicle load models</b>	<b>70</b>
C1 Introduction . . . . .	70
C2 HB Vehicle model . . . . .	70
C3 Application of HB Vehicle load . . . . .	70
<b>Appendix D. Models for wind and thermal actions</b>	<b>73</b>
D1 Wind loading . . . . .	73
D1.1 General . . . . .	73
D1.2 Wind speed . . . . .	73
D1.3 Transverse wind load . . . . .	82
D1.4 Longitudinal wind load . . . . .	92
D1.5 Vertical wind load . . . . .	94
D1.6 Method for calculation of topography factor . . . . .	94
D2 Thermal loading . . . . .	98
D2.1 General . . . . .	98
D2.2 Effective temperatures . . . . .	98
D2.3 Temperature differences . . . . .	102
D2.4 Combining temperature differences with effective temperature . . . . .	106

<b>Appendix E. Assessment of masonry arches using the modified MEXE method</b>	<b>108</b>
E1 Introduction and method of assessment . . . . .	108
E2 Theory . . . . .	108
E3 Survey of the arch . . . . .	110
E4 Provisional assessment . . . . .	111
E5 Modifying factors . . . . .	111
E5.1 Span/rise factor . . . . .	111
E5.2 Profile factor . . . . .	112
E5.3 Material factor . . . . .	113
E5.4 Joint factor . . . . .	114
E5.5 Arch barrel condition factor . . . . .	114
E6 Cracks, deformations and defects . . . . .	114
E6.1 Defects affecting the stability and load carrying capacity of the arch barrel . . . . .	115
E6.2 Defects affecting the stability of the road surface . . . . .	115
E7 Application . . . . .	115
E8 Axle lift-off . . . . .	117
E9 Curved carriageways . . . . .	117
E10 Assessment resistance and weight restrictions . . . . .	117
<b>Appendix F. Partial factor and reliability-based methods of assessment</b>	<b>119</b>
F1 Introduction to methods of assessment . . . . .	119
F1.1 Partial factor method . . . . .	119
F1.2 Reliability-based methods . . . . .	121
F2 Proposals to use reliability-based methods of assessment . . . . .	123
F2.1 General procedure . . . . .	123
F2.2 Methods and criteria . . . . .	123

## Release notes

Version	Date	Details of amendments
0	Jun 2019	<p>CS 454 replaces BD 21/01 and BA 16/97, and includes some additional material derived from BD 37/01.</p> <p>The full document has been re-written to make it compliant with the new Highways England drafting rules. Many improvements have been made to the presentation of the technical requirements to improve ease of use, and improve consistency with related assessment documents.</p> <p>The main technical themes of the update include:</p> <ol style="list-style-type: none"> <li>1) the inclusion of wind, thermal and HB load models in new appendices, previously in BD 37;</li> <li>2) traffic load models modified to be able to cater for loaded lengths greater than 50 m, previously in BD 50;</li> <li>3) increase in the lane width for ALL model 1 (based on real vehicles) in the single vehicle load case;</li> <li>4) consolidation of the material relating to masonry arch assessment into a single new chapter with clearer requirements that are not as focussed on the use of the modified MEXE method;</li> <li>5) additional restrictions to the use of the modified MEXE method;</li> <li>6) specific requirements for fatigue assessment have been removed pending further study and development of fatigue assessment rules;</li> <li>7) guidance on levels of assessment and reliability methods for assessment included previously in BD 79;</li> <li>8) assessment of substructures moved to CS 459;</li> <li>9) content specific to particular structural materials moved to the updates of the relevant assessment documents.</li> </ol>

## Foreword

### Publishing information

This document is published by Highways England.

This document supersedes BD 21/01, BA 16/97 and BD 37/01, which are withdrawn.

### Contractual and legal considerations

This document forms part of the works specification. It does not purport to include all the necessary provisions of a contract. Users are responsible for applying all appropriate documents applicable to their contract.

## **Introduction**

### **Background**

The use of this document enables the structural safety and serviceability of highway bridges and structures to be assessed, providing key information that is required to manage risks and maintain a safe and operational network.

### **Assumptions made in the preparation of the document**

The assumptions made in GG 101 [Ref 2.N] apply to this document.

## Abbreviations and symbols

### Abbreviations

Abbreviation	Meaning
AAHHGVF	Annual average hourly HGV flow
AIP	Approval In principle
ALL	Assessment live loading
CFRP	Carbon fibre reinforced polymer
FE	Fire engine
HGV	Heavy goods vehicle
KEL	Knife-edge load
MAL	Modified axle load
MEXE	Military Engineering Experimental Establishment
PAL	Permissible axle loading
SLS	Serviceability limit state
TRACS	Traffic speed condition survey
UDL	Uniformly distributed load
ULS	Ultimate limit state

### Symbols

Symbol	Definition
$A$	Cross-section area
$b$	Abutment width in masonry arches
$D$	Overall depth of deck
$d$	Depth of the bare girder at mid-span
$F_A$	Centrifugal effect factor
$F_c$	Condition factor
$f_c$	Compressive yield strength of cast iron
$F_{cM}$	Arch barrel condition factor
$F_d$	Joint depth factor
$f_{ef}$	End fixity factor
$F_I$	Section modulus factor
$F_j$	Joint factor
$f_k$	Characteristic, nominal or worst credible strength of material
$F_{mo}$	Mortar factor
$f_p$	Permissible strength of cast iron
$F_w$	Joint width factor
$h$	Depth of fill in masonry arches

**Symbols** (continued)

$K$	Reduction factor
$K_r$	Minimum radius of gyration
$L$	Loaded length
$L_s$	Strut length
$L_t$	Dispersion length for troughing
$n_m$	Number of marked lanes
$n_{max}$	Minimum number of notional lanes
$n_{min}$	Minimum number of notional lanes
$n_n$	Number of notional lanes
$P$	Pedestrian live load
$P_c$	Limiting compressive force in a cast iron strut
$Q_a$	Assessment actions
$Q_k$	Characteristic actions
$Q_L$	Longitudinal braking or traction load
$r$	Radius of curvature of carriageway
$R_a$	Assessment resistance
$R_{skew}$	Assessment resistance of a skew arch
$R_{square}$	Assessment resistance of a square arch
$s$	Axle spacing for normal traffic for masonry arches
$S_a$	Assessment action effects
$v$	Maximum speed at which HGVs are permitted to drive along the curved carriageway on a bridge
$w$	Bridge width with masonry arches
$W_i$	Characteristic accidental wheel loads for cantilevered members
$W_L$	Equivalent static load
$W_t$	Troughing load
$\alpha$	Skew angle in masonry arches
$\gamma_{fl}$	Partial factor for load
$\gamma_m$	Partial factor for material strength
$\gamma_{f3}$	Partial factor for load effects
$\sigma_g$	Stress due to permanent load in cast iron
$\sigma_{tr}$	Tensile stress limit for traffic loading in cast iron
$\tau_g$	Shear stress due to permanent load
$\tau_{tr}$	Shear stress due to traffic loads only

## Terms and definitions

### Terms

Term	Definition
Abnormal traffic	Traffic that does not comply with the definition of normal traffic.
Action	An imposed load or displacement. NOTE 1: Actions on bridges include traffic loads, dead load, superimposed dead load, thermal actions, wind actions.
Arch barrel	The single structural arch element formed by one or more arch rings.
Arch ring	A single ring of brickwork, stonework or concrete block masonry of approximately even size formed to an arch profile.
Assessment	The process of determining in terms of vehicle loading the load that an existing structure can carry with an acceptable probability that it does not suffer serious damage that can endanger any persons on or near the structure.
Assessment live loading	Traffic load models representing normal traffic or restricted traffic.
Bearing	The structural component used to transmit loading from the superstructure to the substructure.
Bogie	A group of two or three closely spaced axles in a vehicle.
Carriageway width	The width of running surface including hard shoulders, between kerbs, raised paving or barriers.
Centrifugal effects	Additional loading from traffic that is travelling on a horizontally curved path.
Dead load	Loading due to the weight of the materials forming the structure or structural elements.
Eurocodes	The suite of European standards for structural and geotechnical design including BS EN 1990 [Ref 12.1] and the associated standards for actions and resistance.
Heavy goods vehicle	Includes all goods vehicles over 3.5 tonnes gross vehicle weight.
Live loads	Loads from traffic and other variable actions.
Loaded length	The base length of that area under the live load influence line which produces the most adverse effect at the section being considered
Masonry arch	An arch built of brickwork, stonework or concrete block masonry.
Modified MEXE method	An empirical method for the assessment of masonry arch bridges
Permissible stress	The stress which it is safe to allow under specified assessment loading (used for cast iron bridges).

## Terms (continued)

Term	Definition
Normal traffic	<p>Highway traffic comprising vehicles of a type and weight that is authorised to use highways without special permission.</p> <p>NOTE 1: In England, Wales and Scotland, normal traffic refers to traffic complying with The Road Vehicles (Authorised Weight) Regulations 1998 as amended [Ref 31.I] and The Road Vehicles (Construction and Use) Regulations 1986 as amended [Ref 32.I].</p> <p>NOTE 2: In Northern Ireland, normal traffic refers to traffic complying with the Motor Vehicles (Authorised Weight) Regulations (Northern Ireland) 1999 as amended [Ref 21.I] and the Motor Vehicles (Construction and Use) Regulations (Northern Ireland) 1999 as amended [Ref 22.I].</p> <p>NOTE 3: Normal traffic does not cover the passage of vehicles complying with the Road Vehicles (Authorisation of Special Types) (General) Order 2003 as amended [Ref 30.I] or the Motor Vehicles (Authorisation of Special Types) Order (Northern Ireland) 1997 as amended [Ref 20.I], except for Category 1 vehicles which have gross vehicle weights of up to 46 tonnes.</p>
Notional lane	A notional part of the carriageway assumed solely for the purpose of applying specified traffic loads.
Provisionally substandard structure	Structure that is deemed to be sub-standard without an assessment (for examples scour, impact damage, deterioration) or assessed to have sub-standard resistance at any stage during the assessment process, regardless of whether it is considered appropriate to progress the assessment further.
Restricted traffic	Highway traffic limited by a specified weight restriction, comprising vehicles with a limited gross vehicle weight, where the limit is less than the normal traffic limitations.
Spandrel wall	Wall which is founded on the edge of an arch barrel to retain the infill.
Substandard structure	<p>A structure that has been assessed to be sub-standard in terms of meeting the carriageway loading requirements given in this document or by other means (as examples by scour, impact damage, deterioration), and retaining walls that have been found to be sub-standard either according to the principles in this document or by other means, after carrying out an appropriate assessment.</p> <p>NOTE The definition of sub-standard structures does not apply to structures with sub-standard non-primary load carrying elements that are not directly affected by carriageway loading (such as sub-standard parapets, and bridge supports at risk from collision).</p>
Superimposed dead load	The weight of all materials on the structure that are not structural elements, such as surfacing, parapets, spandrel walls, service mains, ducts, miscellaneous street furniture, fill, etc.
Type HA loading	A traffic load model developed to represent the effects of normal traffic on longitudinally spanning bridge decks, previously included in BD 37 2001 [Ref 17.I] (withdrawn) for design, and in BD 21 2001 [Ref 27.I] (withdrawn) for assessment.

**Terms** (continued)

<b>Term</b>	<b>Definition</b>
Type HB loading	A traffic load model to represent the effects of abnormal traffic loads, previously included in BD 37 2001 [Ref 17.1] (withdrawn) for design.
Voussoir	Wedge-shaped masonry unit in an arch.

## 1. Scope

### Aspects covered

1.1 This document shall be used for the assessment of:

- 1) highway bridges and structures constructed of steel, concrete, wrought iron and cast iron;
- 2) brick and stone masonry arches.

*NOTE This document does not cover methods for assessment of timber structures nor stone slab bridge decks.*

### Implementation

1.2 This document shall be implemented forthwith on all schemes involving assessment of highway bridges and structures on the Overseeing Organisations' motorway and all-purpose trunk roads according to the implementation requirements of GG 101 [Ref 2.N].

### Use of GG 101

1.3 The requirements contained in GG 101 [Ref 2.N] shall be followed in respect of activities covered by this document.

## 2. Assessment processes

### General

2.1 The assessment shall be carried out according to the processes shown in Figure 2.1.

Figure 2.1 Assessment processes

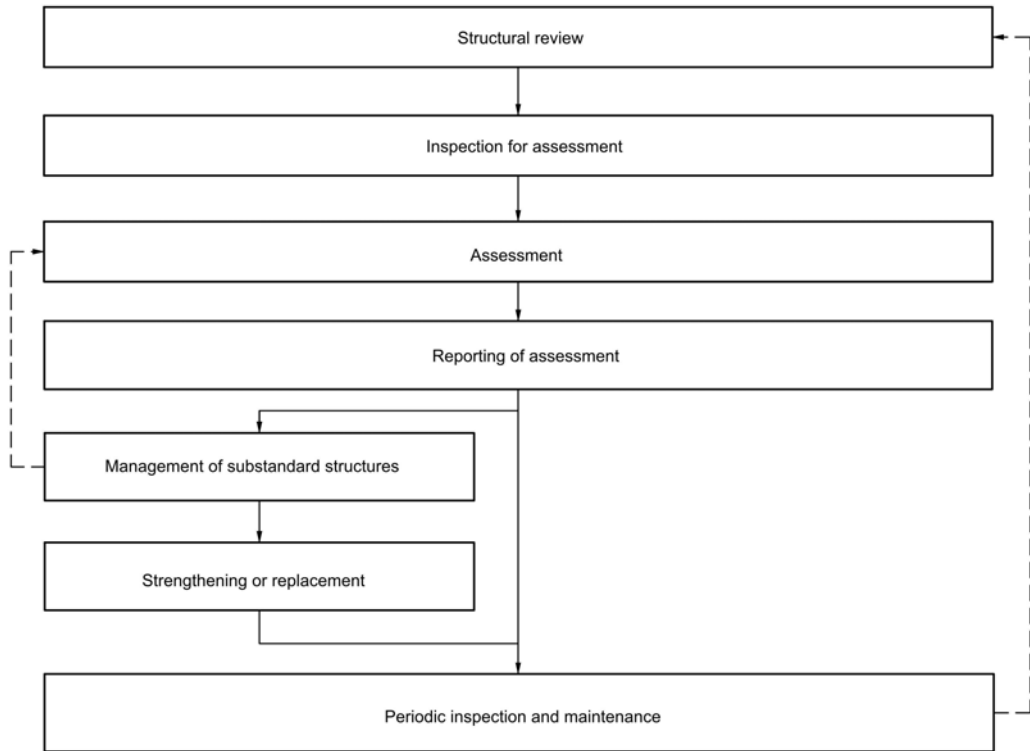

### Structural review

2.2 The need for an assessment shall be identified through the structural review process in accordance with BD 101 [Ref 3.N].

*NOTE* The structural review and assessment can be triggered by a range of factors including changes in condition observed in inspections, and proposed changes in use or abnormal loading. Requirements are provided in BD 101 [Ref 3.N].

### Inspection for assessment

2.3 All existing information pertaining to the structure shall be collected and reviewed to determine what information is required from the inspection for assessment and which items require special attention.

*NOTE 1* Relevant information can include historical design documents, as-built drawings, data regarding ground properties and geotechnical parameters, past inspection and assessment reports, and monitoring records.

*NOTE 2* As-built and historic records for old structures can be unreliable however they can be of use in determining the further information needed to be obtained from the inspection and which items require special attention.

2.3.1 The source and reference to historical records and the reliance on that information used for the inspection for assessment should be recorded along with the limitations.

- 2.4 An inspection for assessment shall be carried out to identify or confirm the following:
- 1) the form of construction;
  - 2) the geometry of the structure;
  - 3) the geometry of the carriageway and lane markings, including horizontal alignment;
  - 4) the nature and condition of the structural components;
  - 5) values of parameters needed to determine the structural resistance;
  - 6) the condition of the structure, including signs of distress, damage or deterioration;
  - 7) evidence of previous strengthening works;
  - 8) changes to the loading or resistance due to the installation of services;
  - 9) whether previously identified defects have worsened;
  - 10) the road surface category.

*NOTE 1 Trial holes, boreholes or other investigations can be used when needed to identify or confirm information.*

*NOTE 2 Advice on inspection procedures is provided in BD 63 [Ref 1.N].*

*NOTE 3 General inspections are unlikely to be adequate for assessment purposes because the assessment of the structure often requires more detailed information to be obtained than is required for a general inspection.*

*NOTE 4 Guidance on identifying hidden defects in bridges is provided in CIRIA C764 [Ref 15.I].*

- 2.5 All of the defects identified in the inspection for assessment shall be recorded in the Overseeing Organisation's bridge management system and in the assessment report.

#### **Inspection for assessment of steel and wrought iron bridges, concrete bridges and steel composite bridges**

- 2.6 The inspection for assessment of steel and wrought iron bridges, concrete bridges and steel composite bridges shall be carried out in accordance with this document and the additional requirements of BD 56 [Ref 8.N], BD 44 [Ref 6.N] and BD 61 [Ref 5.N] respectively.
- 2.7 Steel components produced prior to 1922 and wrought iron components shall be closely inspected for laminations, cracks, inclusions and deformities.

*NOTE 1 The pre-1922 steels and wrought iron can be of variable quality.*

*NOTE 2 Splices on flanges and webs can govern the strength, especially in old bridges.*

- 2.8 Where there is evidence of corrosion of steel components, or reason to suspect it, measurements of thickness shall be recorded.

*NOTE A typical location for corrosion in steel members is at the base of a web plate.*

- 2.9 Rivets shall be examined for corrosion, especially on the underside of decks or in places where access for maintenance is difficult.

#### **Inspection for assessment of masonry arch bridges**

- 2.10 The exterior of masonry arches shall be inspected.
- 2.10.1 Where the strength of the bridge is in doubt or if internal scour and leaching of the fill is suspected, internal investigation should be carried out.
- NOTE Internal investigation can also provide information on strengthening rings or saddles, and identify the position and size of services laid over or through the arch rings.*
- 2.11 The road surface and footway above masonry arches shall be inspected for signs of rupture and damage.

- 2.12 The inspection for assessment for the arch barrel of masonry arch bridges shall include:
- 1) nature and condition of the brickwork, stonework or concrete block masonry, including the location and extent of any spalling or areas of microcracking induced by high compressive stresses;
  - 2) thickness of the arch barrel;
  - 3) thickness of the joints and depth of missing mortar;
  - 4) condition of the mortar;
  - 5) widths, lengths, position and number of cracks;
  - 6) location of displaced voussoirs or brickwork;
  - 7) identification of arch ring separation;
  - 8) deformation of the arch barrel from its original shape.
- NOTE** *The thickness of the arch ring under the carriageway is not always the same as the thickness of the arch ring under the parapet.*
- 2.13 The inspection for assessment of parapets and spandrel walls of masonry arch bridges shall record the element geometry and evidence of defects and their extent, including:
- 1) tilting, bulging or sagging;
  - 2) lateral movement relative to the arch barrel;
  - 3) weathering and lack of pointing;
  - 4) evidence of impact damage;
  - 5) cracking, splitting and spalling;
  - 6) loosening of coping stones.
- Inspection for assessment of buried structures, sub-structures, foundations, retaining walls, wing walls and dry-stone walls**
- 2.14 All accessible parts of buried structures, sub-structures, foundations, retaining walls, wing walls and dry stone walls shall be examined and any defects noted.
- 2.15 The inspection for assessment of buried structures, sub-structures, foundations, retaining walls, wing walls and dry-stone walls shall be in accordance with this document and the additional requirements contained in CS 459 [Ref 4.N].
- Road surface category**
- 2.16 For the purposes of the assessment, the road surface category over the structure shall be recorded as one of the following:
- 1) good;
  - 2) poor.
- NOTE 1** *The purpose of the road surface category is to enable the dynamic effects of traffic passing over the structure to be estimated as part of the assessment of traffic loading. The magnitude of the loading is dependent on the ride quality of the road surface.*
- NOTE 2** *The estimation of the road surface category does not affect the requirements for pavement assessment in HD 29 [Ref 7.I].*
- 2.16.1 For the purposes of the assessment, a road surface category of poor may be assumed, for example where there is insufficient information with which to justify a good surface category, or where it is expected that deterioration of the surfacing can occur.
- 2.16.2 For the purposes of the assessment, the road surface category may be assumed to be good where both the following apply:
- 1) the current road surface category is good;

- 2) the road can be expected to be well maintained for the remaining life of the structure.
- 2.16.3 The current road surface category may be determined using one of the following methods:
- 1) traffic speed condition survey (TRACS) in accordance with HD 29 [Ref 7.I];
  - 2) observations from a vehicle in free-flowing traffic or observation of the passage of HGVs over the structure.
- 2.16.4 Where TRACS is used to assess the road surface category, the road surface category should be categorised as poor if the TRACS ride quality condition category is 3 or 4 in accordance with HD 29 [Ref 7.I].
- 2.16.5 Where observations of the movement of vehicles are used to assess the current road surface category, the road surface of motorways and trunk roads should be categorised as poor if any of the following conditions are noted:
- 1) subsidence, dip in the road or poor profile run-on slab;
  - 2) the bridge is in a dip;
  - 3) the vehicle bounces in such a manner that the driver or passengers are aware of significant alterations in their seat pressure whilst on any part of the bridge or run-on slab;
  - 4) sub-base deterioration;
  - 5) the vehicle pitches locally due to change in short wave length vertical road profile on the bridge;
  - 6) any obvious visually extensive or severe deterioration to the surface, such as potholing;
  - 7) any noticeable steps in expansion joints on the bridge that are felt as well as heard by the driver.

## Assessment

### Definition of the scope of the assessment

- 2.17 The scope of the assessment shall be defined and agreed in the AIP for the assessment, including:
- 1) the extents of the structure to be assessed;
  - 2) the actions to be included in the assessment;
  - 3) the limit states to be included in the assessment.
- 2.17.1 Where the structure is particularly vulnerable to actions other than those required in Section 5, the need to include them in the assessment should be agreed with the Overseeing Organisation.
- NOTE 1** *Wind, thermal or longitudinal traffic actions can be critical for some types of structure, but can typically be neglected for common situations where the risk of such actions being critical for assessment is low.*
- NOTE 2** *Assessment of highway structures for abnormal traffic loading (STGO and SO vehicles) is covered in BD 86 [Ref 7.N].*
- NOTE 3** *The HB load models for abnormal traffic loading that were previously defined in BD 37 2001 [Ref 17.I] (withdrawn) for design are included in Appendix C for reference and for exceptional cases where an HB assessment is required by the Overseeing Organisation.*
- 2.18 The limit states to be assessed shall include:
- 1) limit states required to be assessed according to this document;
  - 2) limit states required to be assessed according to the related documents for assessment of resistance (including BD 44 [Ref 6.N] BD 56 [Ref 8.N], and BD 61 [Ref 5.N]);
  - 3) any other limit states that are agreed with the Overseeing Organisations to be assessed for a particular structure.
- 2.18.1 Serviceability verifications should be omitted for assessment where all of the following conditions apply:

- 1) there are no specific requirements for serviceability verifications in the relevant assessment documents for the type of structure, material or component (for example, this document and BD 44 [Ref 6.N], BD 56 [Ref 8.N], and BD 61 [Ref 5.N]);
- 2) there has not been a change in use or increase in loading;
- 3) no serviceability-related concerns have been identified.

2.18.2 Where there is a specific concern relating to fatigue, the need for fatigue verifications should be agreed with the Overseeing Organisations.

*NOTE 1 Requirements and guidance on identifying the need for a fatigue assessment are provided in BD 56 [Ref 8.N], BD 44 [Ref 6.N] and BD 61 [Ref 5.N].*

*NOTE 2 Requirements for assessment of cast iron structures, including permissible stresses that provide assurance against fatigue, are given in Section 8.*

2.19 Where it is proposed to carry out fatigue or serviceability assessment verifications based on calculations, the approach to the verifications shall be defined in the AIP for the assessment or agreed with the Overseeing Organisation.

### Carrying out the assessment

2.20 The assessment shall determine in terms of traffic loading the load that the structure can carry with an acceptable probability that it does not suffer serious damage that can endanger any persons on or near the structure, or cause loss of function.

2.20.1 Where a simple conservative assessment is insufficient to demonstrate the safety of a structure, the use of higher levels of assessment based on refinement of the structural analysis method or updated structure-specific information should be carried out, as illustrated in Table 2.20.1.

**Table 2.20.1 Levels of assessment**

Assessment level	Example criteria
Level 1	Simple structural analysis methods. Conservative assumptions for material properties.
Level 2	Refined structural analysis methods, including non-linear or plastic analysis methods.
Level 3	Use of material properties derived from testing samples of the structure, or use of bridge-specific assessment live loading models derived from the measurement of loading data.

*NOTE 1 Reduced values of partial factors for materials that can be used with worst credible strengths derived from testing are provided in BD 56 [Ref 8.N], BD 44 [Ref 6.N] and BD 61 [Ref 5.N].*

*NOTE 2 Where any upper-bound mechanism analysis based on a valid, compatible failure mechanism suggests there is insufficient load-carrying capacity then further assessment based on refined structural analysis methods is unlikely to be worthwhile.*

*NOTE 3 Load testing is covered in CS 463 [Ref 16.I].*

2.21 Where an immediate risk to public safety is identified at any stage of the assessment process, the provisions of BD 79 [Ref 9.N] for immediate-risk structures shall be followed.

*NOTE Guidance relating to the identification of immediate-risk structures and requirements for the application of emergency interim measures for immediate-risk structures are provided in BD 79 [Ref 9.N].*

### Reporting the assessment

2.22 The assessment shall be documented in a report in accordance with the requirements of BD 101 [Ref 3.N].

- 2.23 The assessment report shall state the assessment live loading level corresponding to the level of traffic loading that the structure has been assessed to have sufficient capacity to carry.

### **Management of substandard structures**

- 2.24 Where any highway structure is assessed to be substandard, or provisionally substandard, BD 79 [Ref 9.N] shall be used to manage the structure.

*NOTE 1 Requirements and advice on the use of interim measures such as weight restrictions, lane closures, propping and the use of monitoring are provided in BD 79 [Ref 9.N].*

*NOTE 2 Requirements and advice for immediate-risk structures are provided in BD 79 [Ref 9.N].*

### 3. Basis of assessment

#### Method of assessment

3.1 The partial factor method shall be used for carrying out assessment verifications, except where other methods are permitted by this document.

*NOTE 1 The use of probabilistic reliability-based assessment methods is not covered by this document. Advice is provided in Appendix F.*

*NOTE 2 Cast iron bridges are assessed on a permissible stress basis using different partial factors (see Appendix A), and restricting stresses to permitted limits (see Section 8).*

*NOTE 3 Where masonry arches are assessed using the Military Engineering Experimental Establishment (MEXE) method, the allowable axle and bogie loads are determined directly without the need for limit state verifications.*

#### Limit states

3.2 The assessment shall include verifications at the ultimate limit state.

3.2.1 The assessment may include verifications at the serviceability limit state.

*NOTE Section 2 covers assessment processes including the definition of limit states to be assessed, which can include the serviceability limit state.*

3.2.2 The assessment may include fatigue verifications.

*NOTE Section 2 covers assessment processes including the definition of limit states to be assessed, which can include fatigue.*

#### Assessment actions

3.3 The assessment actions,  $Q_a^*$ , shall be determined from the characteristic actions  $Q_k$  and the partial factor for each action  $\gamma_{fL}$  according to Equation 3.3.

#### Equation 3.3 Assessment actions

$$Q_a^* = \gamma_{fL} Q_k$$

3.4 The partial factors for actions at the ultimate limit state shall be obtained from Table 3.4.

**Table 3.4 Partial factors for actions at the ultimate limit state (excluding cast iron bridges)**

Action	$\gamma_{fL}$
Cast iron dead load	1.10 <sup>[1]</sup>
Steel dead load	1.05 <sup>[1]</sup>
Concrete, stone, masonry, timber dead load	1.15 <sup>[1]</sup>
Surfacing superimposed dead load	1.75 <sup>[1]</sup>
Other superimposed dead loads	1.20 <sup>[1]</sup>
Vertical traffic loads for normal traffic and restricted traffic	1.5
Footway and cycle track loading	1.5
Note 1. The partial factors for all parts of the dead and superimposed loads are 1.0 where this gives a more severe total effect.	
Note 2. The partial factors in this table do not apply to cast iron bridges (covered in Appendix A).	

3.4.1 The partial factor for surfacing should be applied to the top 100 mm of road surfacing material.

*NOTE 1 The partial factor for surfacing is higher than for other superimposed dead loads, because it includes an allowance for possible future resurfacing or overlay.*

*NOTE 2 The recommendation to use the higher partial factor on the top 100mm of surfacing is applicable for typical situations when there is no assurance that the thickness of surfacing can not increase in the remaining life of the structure.*

3.5 Where the assessment includes actions not listed in Table 3.4, or an SLS assessment is carried out, or the structure is a cast iron bridge, the partial factors shall be taken from Appendix A.

*NOTE Appendix A includes partial factors for wind, thermal, earth pressure, abnormal traffic loads, and longitudinal traffic loads.*

3.6 Where the assessment includes actions that are not listed in Appendix A, the corresponding partial factors shall be agreed with the Overseeing Organisations.

### Assessment action effects

3.7 The assessment action effects,  $S_a^*$ , shall be obtained from Equation 3.7.

#### Equation 3.7 Assessment action effects

$$S_a^* = \gamma_{f3}(\text{effects of}(Q_a^*))$$

*NOTE 1  $\gamma_{f3}$  is a factor that takes account of inaccurate assessment of the effects of actions such as unforeseen stress distribution in the structure, inherent inaccuracies in the calculation model, and variations in the dimensional accuracy from measured values.*

*NOTE 2 The effects of  $Q_a^*$  are determined from a structural analysis as described in Section 6.*

3.8 The value of  $\gamma_{f3}$  at SLS shall be 1.0.

3.9 The value of  $\gamma_{f3}$  at ULS shall be taken as 1.1, except in the following cases:

- 1) 1.0 for cast iron bridges;
- 2) 1.0 for masonry arches;
- 3) 1.15 for bridges (excluding masonry arches) where the assessment is based on an upper-bound mechanism analysis such as yield-line analysis.

### Assessment resistance

3.10 The assessment resistance,  $R_a^*$ , shall be determined from the material strengths and section properties using Equation 3.10a or, for cast iron, Equation 3.10b.

#### Equation 3.10a Assessment resistance

$$R_a^* = F_C(\text{function of}(f_k, \gamma_m))$$

**Equation 3.10b Assessment resistance for cast iron**

$$R_a^* = F_C(\text{function of}(f_p))$$

where:

$F_C$  is a condition factor, less than or equal to 1.0, accounting for potential reductions in resistance associated with condition that are not already accounted for in the values of material strengths, the partial factors for material strengths or the resistance model,

$f_k$  is the characteristic, nominal or worst credible strength of the material as given in Section 4,

$\gamma_m$  is a partial factor for material strength,

$f_p$  is the permissible stress of cast iron as given in Section 8.

3.11 The resistance function and the values for  $F_C$  and  $\gamma_m$  shall be obtained from:

- 1) BD 44 [Ref 6.N] for concrete structures;
- 2) BD 56 [Ref 8.N] for steel and wrought iron structures;
- 3) BD 61 [Ref 5.N] for composite structures;
- 4) Section 7 for masonry arch structures;
- 5) Section 8 for cast iron structures.

**Verification**

3.12 The structure shall be deemed to be capable of resisting the assessment actions when Equation 3.12 is satisfied.

**Equation 3.12 Verification**

$$R_a^* \geq S_a^*$$

3.12.1 For structures assessed to BD 56 [Ref 8.N], the verification of Equation 3.12 may alternatively be satisfied using the format in Equation 3.12.1.

**Equation 3.12.1 Alternative verification format for steel structures**

$$F_C(\text{function of}(f_k, \gamma_m, \gamma_{f3})) \geq \text{effects of}(Q_a^*)$$

NOTE 1 The position of  $\gamma_{f3}$  is different in Equation 3.12 and Equation 3.12.1.

NOTE 2 The format of Equation 3.12.1 aligns with that used in BD 56 [Ref 8.N].

3.12.2 For composite structures assessed to BD 61 [Ref 5.N], in conjunction with BD 56 [Ref 8.N] and BD 44 [Ref 6.N], the verifications should be carried out without double-counting or neglecting the effect of  $\gamma_{f3}$ .

## 4. Properties of materials

### Unit weights, elastic moduli and coefficients of linear thermal expansion

4.1 The characteristic values for unit weights, elastic moduli and coefficients of linear thermal expansion for materials to be used in the assessment shall be estimated and recorded.

4.1.1 Characteristic values for unit weights, and coefficients of linear thermal expansion should be:

- 1) taken from Tables 4.1.1a and 4.1.1b respectively;
- 2) obtained from the standards that were used for the design of the structure; or
- 3) obtained through testing.

**Table 4.1.1a Unit weights of materials**

Material <sup>[1]</sup>	Unit weights (kg/m <sup>3</sup> )	
Metals	Aluminium	2750
	Cast iron	7200
	Wrought iron	7700
	Steel	7850
Concrete	Reinforced concrete	2400
	Plain concrete	2300
Masonry	Engineering bricks	2200-2300
	Other solid bricks	2100
	Granite	2600-2930
	Sandstone	2200-2400
Timber	Pine timber	480-720
	English oak timber	720-960
	Greenheart timber	1040-1200
	Glued laminated timber	360-410
Surfacing materials	Hot-rolled asphalt	2300
	Bituminous macadam (tar)	2400
	Bituminous macadam (water-bound)	2560
Fill	Sand fill	1600-2000 <sup>[2]</sup>
	Gravel ballast fill	1600-2100 <sup>[2]</sup>
	Hardcore fill	1920
	Crushed slag fill	1440
	Packed stone rubble fill	2240
	Compact earth fill	1600-1800 <sup>[2]</sup>
	Puddled clay fill	1920
	Miscellaneous fill	2200
Advanced composites	CFRP plates	1600
Note 1: For materials not covered in Table 4.1.1a, or for further detail, unit weights can be obtained from BS EN 1991-1-1 [Ref 10.]		
Note 2: The range of values for each type of fill represents the range from dry to wet conditions.		

**Table 4.1.1b Coefficients of linear thermal expansion**

Material	Coefficient of linear thermal expansion (10 <sup>-6</sup> / degree C)
Concrete <sup>[1,2]</sup>	12
Steel	12
Aluminium	26
Cast iron	10
Wrought iron	12
Masonry	4-7
Timber (along the grain)	3-5
CFRP plates parallel to longitudinal fibres	0
<p>Note 1: The value for the coefficient of linear thermal expansion for concrete contains an allowance for the presence of reinforcement.</p> <p>Note 2: The value for the coefficient of linear thermal expansion for concrete can vary depending on the aggregate type. The stated value is a default value intended to be used for assessments where the aggregate type is unknown and where the precise value is not critical for the assessment.</p>	

4.1.2 The modulus of elasticity for concrete, reinforcement and prestressing tendons should be obtained from BD 44 [Ref 6.N].

4.1.3 The modulus of elasticity for steel and wrought iron should be obtained from BD 56 [Ref 8.N].

4.1.4 The modulus of elasticity for cast iron should be assumed to be between 90 and 138 GPa.

### Strengths of materials

4.2 The characteristic or worst credible strengths of materials to be used in assessment shall be determined based on information gained from the following sources:

- 1) as-built drawings and records for the structure;
- 2) standards and specifications used at the time of the design of the structure;
- 3) testing of samples from the structure;
- 4) assumed values based on the guidance in this document.

4.2.1 The yield strength of steel should be determined in accordance with BD 56 [Ref 8.N].

4.2.2 The yield strength for wrought iron should be determined in accordance with BD 56 [Ref 8.N].

4.2.3 The strength of steel reinforcement should be determined in accordance with BD 44 [Ref 6.N].

4.2.4 The strength of prestressing tendons should be determined in accordance with BD 44 [Ref 6.N].

4.2.5 The strength of concrete should be determined in accordance with BD 44 [Ref 6.N].

4.2.6 The strength of cast iron should be assessed using Section 8.

4.2.7 The strength of masonry may be estimated using Figures 4.2.7a and 4.2.7b for brick and stone masonry respectively.

Figure 4.2.7a Characteristic strength of brick masonry

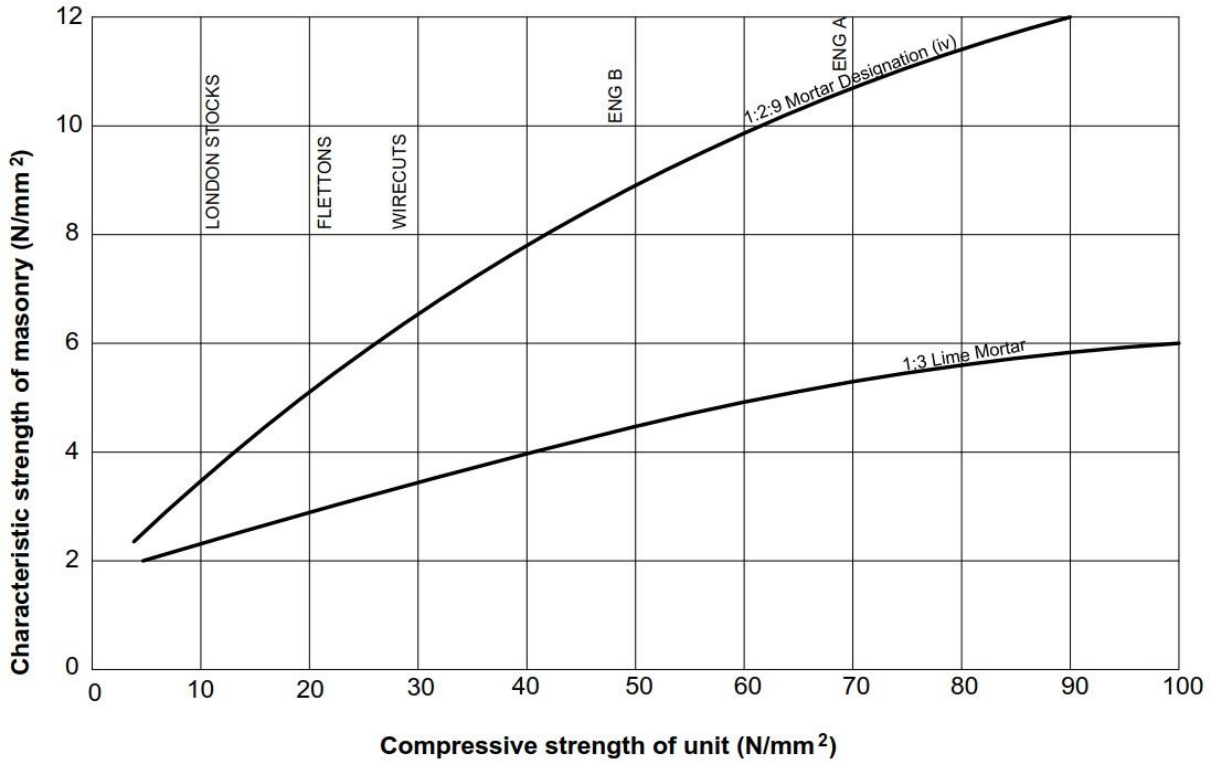
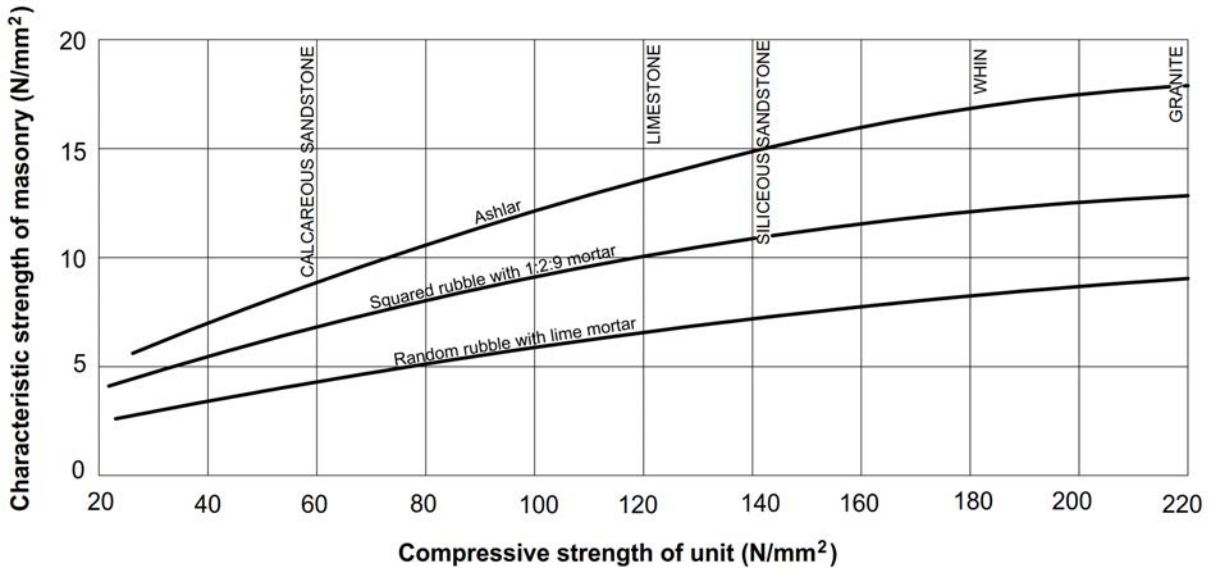

Figure 4.2.7b Characteristic strength of stone masonry



4.2.8 Testing of masonry should be carried out in accordance with TRRL Contractor Report 244 [Ref 18.I] and BS 5628 [Ref 6.I].

## 5. Assessment actions

### General

5.1 The actions to be assessed shall be defined using representative models for assessment.

5.2 The actions to be assessed shall include:

- 1) dead and superimposed dead load;
- 2) carriageway traffic loading;
- 3) accidental vehicle loading;
- 4) footway loading.

5.2.1 The actions to be assessed may include:

- 1) wind loading;
- 2) thermal loading;
- 3) longitudinal traffic loading.

*NOTE* See Section 2 for processes regarding the definition of the scope of the assessment, including agreement of which actions are to be included.

5.3 When modelling the effects of traffic or pedestrian actions on a structure, parts of the structure shall be left unloaded if this causes the most severe effect on the member or element under consideration.

### Dead load and superimposed dead load

5.4 The characteristic actions for dead load and superimposed dead loads shall be derived from the geometry of the structure and the unit weights of materials.

*NOTE 1* Unit weights for materials are provided in Section 4.

*NOTE 2* Section 2 includes requirements for inspection for assessment, including the confirmation of key dimensions.

### Carriageway traffic loading

5.5 The characteristic actions for traffic loading on carriageways shall be defined for assessment using an assessment live loading model that represents:

- 1) the level of traffic to be assessed;
- 2) the influence of the road surface category on the impact effects of vehicles;
- 3) the influence of the traffic flow category on the likelihood of vehicle overloading and lateral bunching.

*NOTE 1* The level of traffic can be categorised as normal traffic, restricted traffic, or abnormal traffic.

*NOTE 2* The road surface category is defined in Section 2.

*NOTE 3* The traffic flow category is defined in Table 5.5N3.

**Table 5.5N3 Traffic flow categories**

Annual average hourly HGV flow (AAHHGVF)	Traffic flow category
AAHHGVF > 70	High (H)
70 > AAHHGVF > 7	Medium (M)
7 > AAHHGVF	Low (L)
Note 1: AAHHGVF is equal to the total annual 2-way HGV flow over the bridge divided by 8760. Note 2: Guidance on obtaining an approximation for AAHHGVF from traffic counts is provided in TRRL SR 802 [Ref 9.I].	

5.5.1 The assessment of abnormal traffic comprising STGO or SOV vehicles should be carried out using BD 86 [Ref 7.N].

5.5.2 The characteristic traffic actions for normal or restricted traffic should be represented using either one of the following assessment live loading (ALL) models:

- 1) ALL model 1;
- 2) ALL model 2.

*NOTE 1 ALL model 1 is suitable for all structures and is based on real vehicles with maximum authorised vehicle weights.*

*NOTE 2 ALL model 2 is suitable for longitudinally spanning bridge decks and is based on nominal Type HA loading as previously included in BD 21 2001 [Ref 27.I] (withdrawn).*

*NOTE 3 ALL model 2 is likely to provide lower effects than ALL model 1 for longer loaded lengths, since it accounts for the reduced probability of the most critical loading effects being experienced on the entire loaded length simultaneously.*

*NOTE 4 ALL model 1 and ALL model 2 both include the effects of road surface category and traffic flow category.*

*NOTE 5 Although they are referred to as characteristic actions, both ALL model 1 and ALL model 2 can be more strictly described as nominal actions that when multiplied by the partial factors in this document provide an assessment load level. The values of the partial factors at SLS and ULS are calibrated on that basis and include an allowance for possible overloading. In contrast, the corresponding characteristic load models in BS EN 1991-2 [Ref 11.I] are higher in magnitude but the associated partial factors in BS EN 1990 [Ref 12.I] are lower.*

5.6 ALL model 2 shall not be used in the following situations:

- 1) structures with transversely spanning trough decks;
- 2) masonry arches with spans less than 20m;
- 3) decks with main members that span transversely, including skew slabs where the traffic loads cannot be assumed to span primarily in the longitudinal direction;
- 4) buried concrete box structures with cover greater than 0.6m;
- 5) structures with longitudinal members at centres of 2.5m or less with low transverse distribution;
- 6) structures with a loaded length of less than 2m.

5.6.1 ALL model 2 may be applied to longitudinally spanning trough decks using the amended method of application described in Section 6.

5.7 Where a structure is assessed to be unable to carry normal traffic, or where a weight restriction is in place, the structure shall be assessed for the effects of restricted traffic, based on the corresponding assessment live loading level.

*NOTE The following assessment live loading levels can be used, expressed as maximum gross vehicle weights:*

- 1) normal traffic, no restrictions;
- 2) 33 tonnes (used for masonry arches only);
- 3) 26 tonnes;
- 4) 18 tonnes;
- 5) fire engines group 1;
- 6) 13 tonnes (used for masonry arches only);
- 7) 10 tonnes (used for masonry arches only);
- 8) 7.5 tonnes;
- 9) fire engines group 2;
- 10) 3 tonnes.

**ALL model 1**

5.8 The ALL model 1 shall consist of vehicle loads, applied in the following situations, considered separately:

- 1) a single vehicle in each lane;
- 2) a convoy of vehicles in each lane.

*NOTE The convoy situation is applicable even when the loaded length can only accommodate a single vehicle.*

5.9 The characteristic loads for ALL model 1 shall be determined from the vehicle loads in Appendix B modified by the following factors:

- 1) an impact factor applied to the most critical axle, obtained from Table 5.9a;
- 2) a traffic flow factor from Table 5.9b;
- 3) a lane factor from Table 5.9c.

**Table 5.9a Impact factors and lane widths**

Load situation	Impact factor applied to critical axle <sup>[1,2]</sup>		Notional lane width	Minimum lateral spacing between wheel centres of adjacent vehicles
	Good road surface <sup>[3]</sup>	Poor road surface <sup>[3]</sup>		
Single vehicle in each lane	1.62	1.8	3m	1.2m
Convoy of vehicles in each lane	1.0		2.5m	0.7m

Note 1: For buried structures with >0.6m fill, the impact factor is applied in one lane only. For other structures the impact factor is applied in all lanes.  
 Note 2: CS 459 [Ref 4.N] includes further rules for buried structures, including a reduction of the impact factor to account for the damping effect of the depth of cover.  
 Note 3: The road surface category is defined in Section 2.

**Table 5.9b Traffic flow factors**

Traffic flow category <sup>[1]</sup>	Traffic flow factor
High	1.0
Medium	0.95
Low	0.9

**Table 5.9b Traffic flow factors** (continued)

Note 1: The traffic flow category is defined in Table 5.5N3.
--

**Table 5.9c Lane factors for ALL model 1**

Lane	Lane factor <sup>[1]</sup>
Lane 1	1.0
Lane 2	1.0
Lane 3	0.5
Lane 4 and subsequent	0.4
Note 1: The lane factors are interchangeable between lanes.	

5.10 For the application of ALL model 1, the carriageway width shall be divided into the maximum integer number of notional lanes of the width given in Table 5.9a and a remaining area.

*NOTE The carriageway width is defined in terms and definitions.*

5.11 The notional lanes for ALL model 1 shall be located to cause the most adverse loading effects on the member or element under consideration.

5.12 When applying ALL model 1, the most onerous effects shall be determined based on the relevant vehicle models in Appendix B corresponding to the level of assessment live loading being assessed.

5.13 For the application of ALL model 1, the vehicles shall be positioned laterally within each notional lane to give the most adverse effect, but no closer than the minimum spacings in Table 5.9a.

5.14 Where a convoy of vehicles is applied, the vehicles shall be placed in each notional lane with a minimum longitudinal spacing of 1.0m between vehicles.

5.15 Where a structure is being assessed for fire engine loading, a maximum of three fire engines shall be applied to the structure, with vehicle loading from the 3 tonne or 7.5 tonne restricted loading level applied to the remainder of the structure.

5.16 Where the assessment live loading exceeds 7.5 tonnes, a UDL of 5kN/m<sup>2</sup> shall be applied over the remaining area of carriageway, except where this provides a relieving effect.

5.16.1 Where the assessment live loading is 7.5 tonnes or lower, the remaining area may be left unloaded.

**ALL model 2**

5.17 The ALL model 2 shall consist of the following loads, applied separately:

- 1) a combined uniform and knife-edge load;
- 2) a single axle load.

**Combined uniform and knife-edge load**

5.18 For the purposes of applying the combined uniform and knife-edge loading, the carriageway width shall be divided into a number of notional lanes,  $n_n$ , using Equation 5.18.

**Equation 5.18 Number of notional lanes**

$$n_n = n_m$$

but not less than  $n_{min}$   
and not greater than  $n_{max}$

where:

- $n_n$  is the number of notional lanes
- $n_m$  is the number of marked lanes (including hard shoulder)
- $n_{min}$  is the minimum number of notional lanes taken from Table 5.19
- $n_{max}$  is the maximum number of notional lanes taken from Table 5.19

**Table 5.18 Minimum and maximum limits on number of notional lanes**

Carriageway width, $C$ (m)	$n_{min}$	$n_{max}$
$C < 5.0$	1	2
$5.0 \leq C < 7.5$	2	2
$C = 7.5$	2	3
$7.5 < C < 10$	3	3
$10 \leq C \leq 10.95$	3	4
$10.95 < C < 12.5$	4	4
$12.5 \leq C \leq 14.6$	4	5
$14.6 < C < 15$	5	5
$15 \leq C < 17.5$	5	6
$17.5 \leq C \leq 18.25$	5	7
$18.25 < C < 20$	6	7
$20 \leq C \leq 21.9$	6	8

Note: For  $C > 7.5$  m (including carriageways wider than listed in the table),  $n_{min}$  is based on the minimum integer value of  $n_n$  for which  $\frac{C}{n_n} \leq 3.65$  m, and  $n_{max}$  is based on the maximum integer value of  $n_n$  for which  $\frac{C}{n_n} \geq 2.5$  m.

5.18.1 The notional lanes should be assumed to be equally distributed across the carriageway width.

5.19 The combined uniform and knife-edge loading, applied in each lane, shall consist of a uniformly distributed load (UDL) together with a single knife-edge load (KEL), determined in accordance with Table 5.19a, modified by the following factors:

- 1) The lane factors in Table 5.19b;
- 2) The K-factors accounting for surface category and traffic flow category given in Figures 5.19a to 5.19f and Table 5.19c.

**Table 5.19a Uniform and knife-edge loading**

Loaded length, $L$ (m)	UDL (kN/m)	KEL (kN)
$L \leq 20\text{m}$	$\frac{230}{L^{0.67}}$	82
$20\text{m} < L < 40\text{m}$	$\frac{336}{L^{0.67}} \cdot \frac{1}{1.92 - 0.023L}$	$\frac{120}{1.92 - 0.023L}$
$40\text{m} \leq L \leq 50\text{m}$	$\frac{336}{L^{0.67}}$	120
$L > 50\text{m}$	$\frac{36}{L^{0.1}}$	120

**Table 5.19b Lane factors for ALL model 2**

Lane	Lane factor
Lane 1	1.0
Lane 2	$\max\left(0.67, \frac{7.1}{\sqrt{L}}\right)$ when $L > 50\text{ m}$ and $N < 6$
	1.0 in all other cases
Lane 3	0.5
Lane 4 and subsequent	0.4
<p>Note 1: Where the bridge carries two-way traffic, <math>N</math> is taken as the total number of notional lanes on the bridge, including all notional lanes for dual carriageway roads.</p> <p>Note 2: Where the bridge carries one-way traffic only, the value of <math>N</math> is taken as twice the number of notional lanes on the bridge.</p> <p>Note 3: The lane factors are interchangeable between lanes.</p>	

Figure 5.19a K-factor for high traffic flow, poor surface

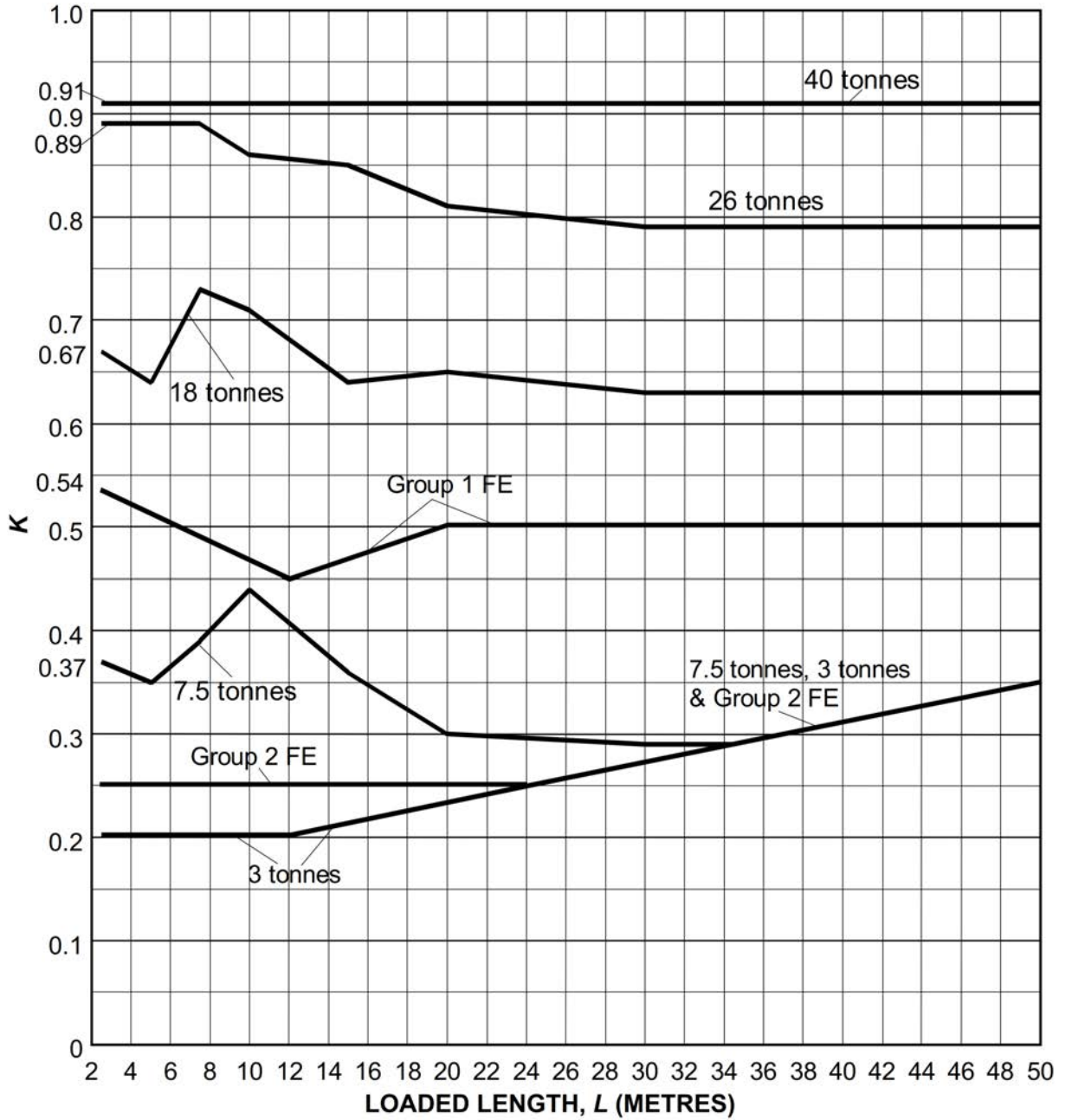

Licensed copy from CIS: RAMBOLLUK, Ramboll UK Ltd, 23/07/2019, Uncontrolled Copy.

Figure 5.19b K-factor for medium traffic flow, poor surface

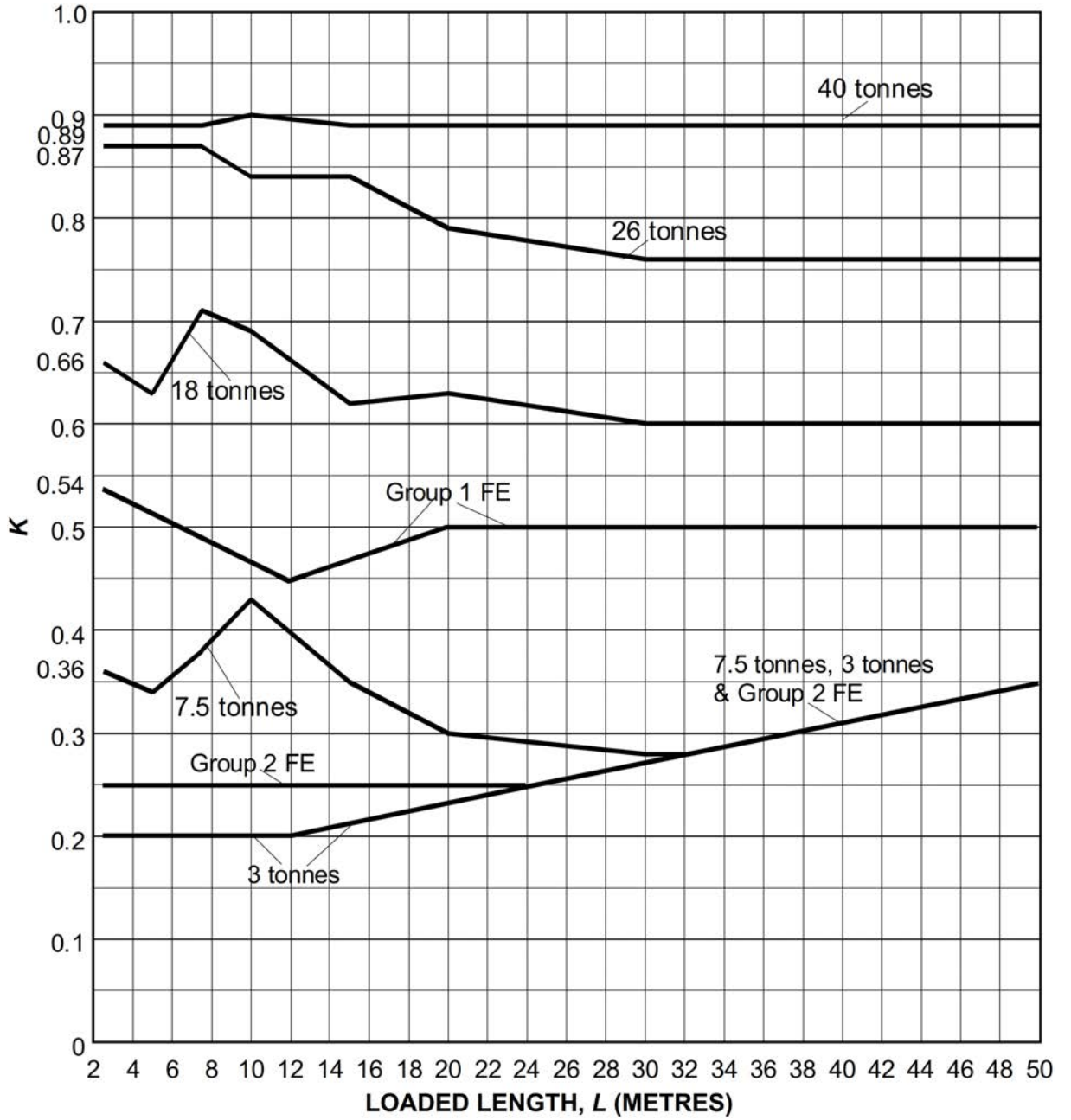

Figure 5.19c K-factor for low traffic flow, poor surface

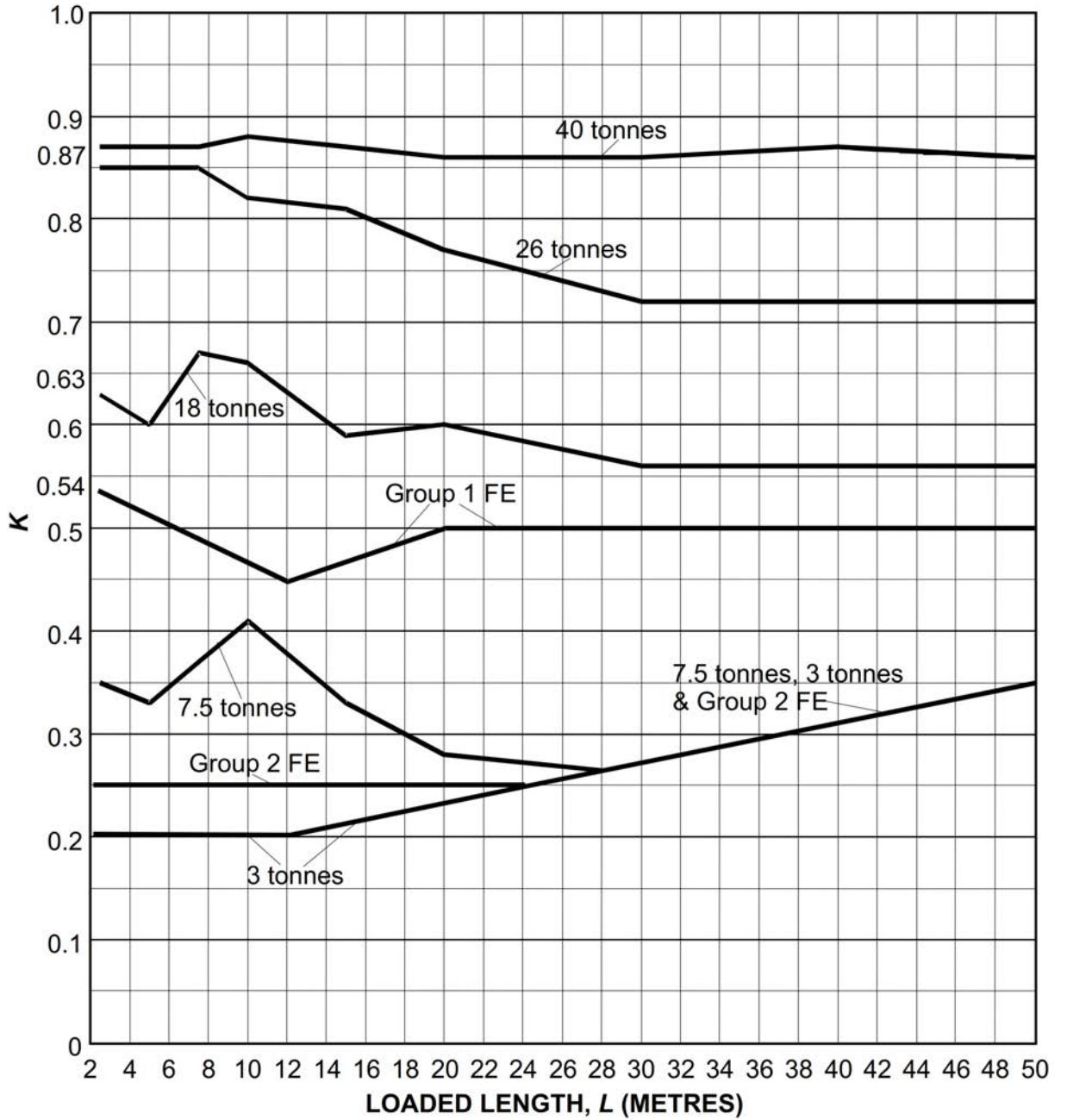

Figure 5.19d K-factor for high traffic flow, good surface

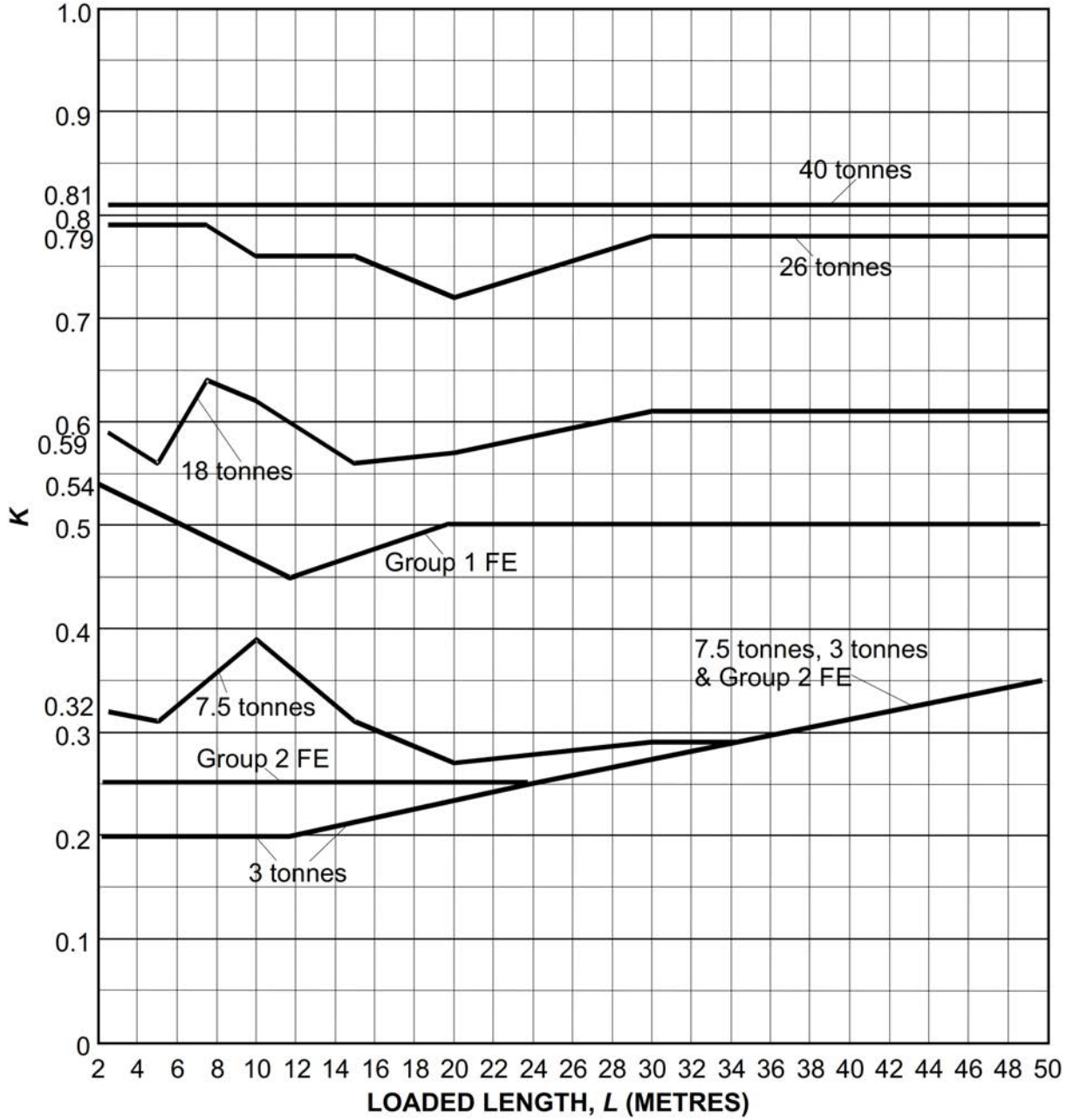
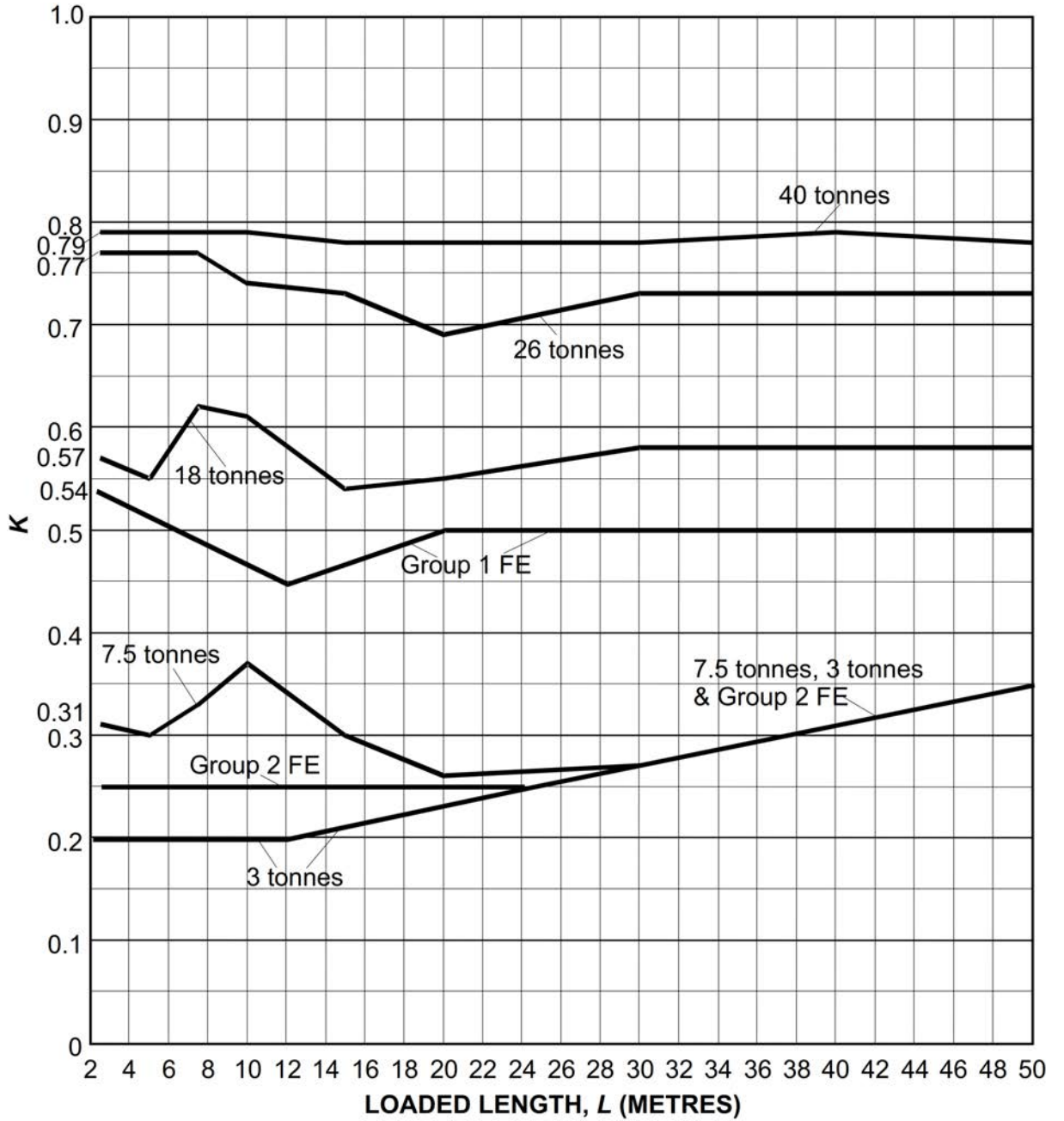

Figure 5.19e K-factor for medium traffic flow, good surface



Licensed copy from CIS: RAMBOLLUK, Ramboll UK Ltd, 23/07/2019, Uncontrolled Copy.

Figure 5.19f K-factor for low traffic flow, good surface

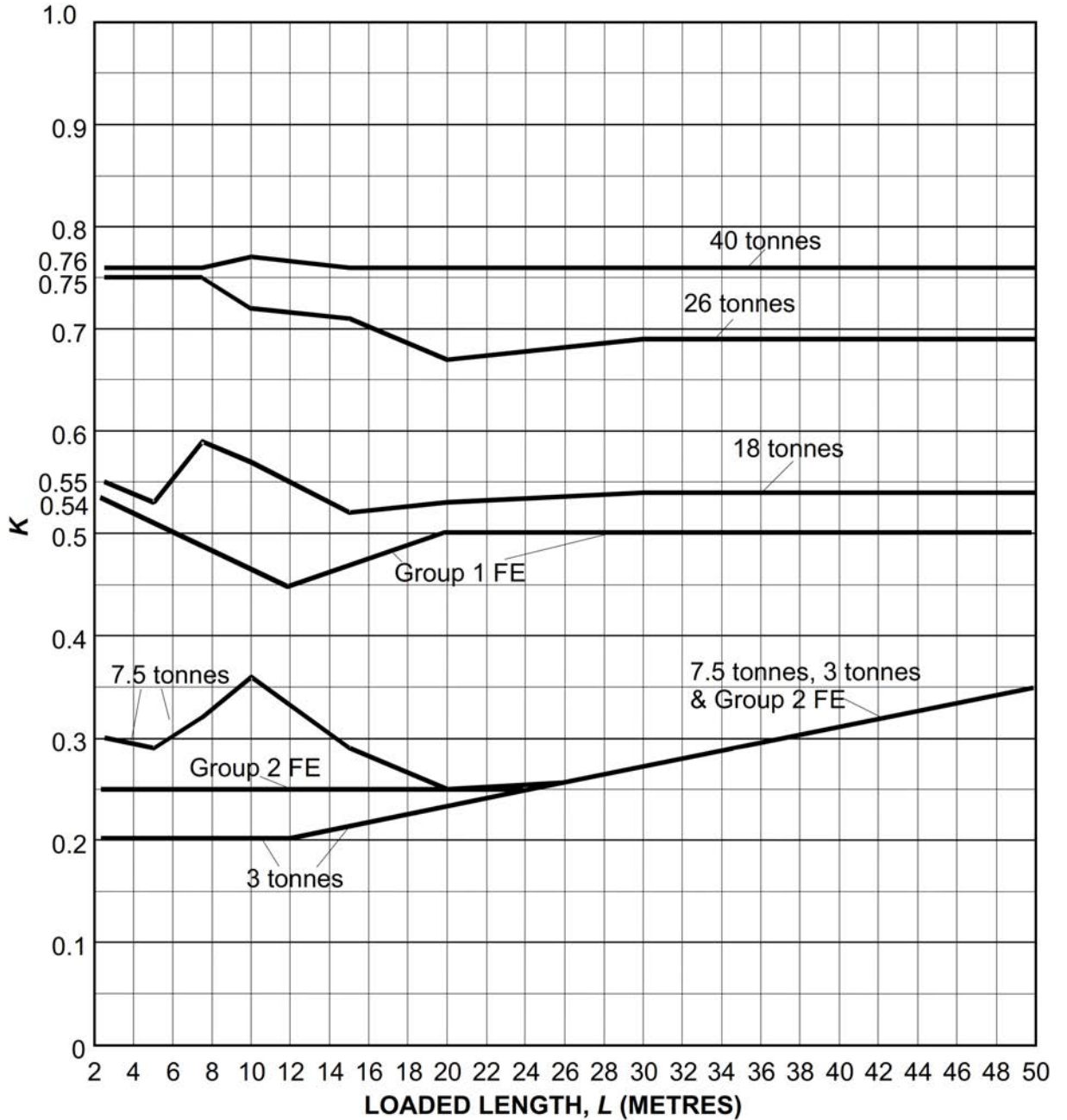

Table 5.19c K-factors for loaded lengths over 50m

Assessment live loading level	K
Normal traffic	0.91
7.5 tonnes	0.4

NOTE In Figures 5.19a to 5.19f, "40 tonnes" refers to normal traffic.

- 5.20 The combined uniform and knife-edge loading shall be applied uniformly across a width of 2.5m in the most onerous transverse position in each notional lane.
- 5.21 The combined uniform and knife-edge loading shall be applied in the appropriate parts of the influence line to cause the most severe effect on the member or element under consideration.

**Single axle loading**

5.22 The single axle loading shall consist of the most critical axle of ALL model 1, applied in each lane, using the same axle loads, wheel spacing, wheel dimensions, load situations, lane widths, traffic flow factors, lane factors and impact factors as for ALL model 1.

*NOTE* Notional lanes used for the application of combined uniform and knife-edge loading are not applicable for the single axle load.

5.22.1 Where the carriageway width is such that it cannot accommodate an integral number of lanes, the remaining area should not be loaded for the application of single axle loading.

5.22.2 Where one wheel of the single axle loading has a relieving effect, the load from the relieving wheel should be taken as zero.

5.23 The single axle load shall be positioned to cause the most severe effect on the member or element under consideration.

**Centrifugal effects**

5.24 Where the vertical effects arising from centrifugal action on horizontally curved carriageways are being assessed, they shall be determined by deriving an equivalent static live load which is adjusted by the centrifugal effect factor,  $F_A$ , determined in accordance with Equation 5.24.

**Equation 5.24 Centrifugal effect factor**

$$F_A = \min \left\{ 2, \left( 1 + \frac{0.2v^2}{r} \right), \left( 1 + \frac{200}{r + 150} \right) \right\}$$

where:

- $v$  is the maximum speed at which HGVs are permitted to travel along the curved carriageway on the bridge (m/s)
- $r$  is the radius of curvature of carriageway (m)

5.24.1 The vertical effects arising from centrifugal action on horizontally curved carriageways may be omitted from the assessment where the centrifugal effect factor is less than 1.25.

5.24.2 The vertical effects arising from centrifugal forces on horizontally curved carriageways may be taken as zero where any of the following criteria apply:

- 1) the horizontal radius of curvature of the carriageway is greater than 600m;
- 2) the span of the longitudinal element under consideration is greater than 15m;
- 3) the bridge has a reinforced or prestressed concrete slab deck.

5.24.3 The vertical effects arising from centrifugal forces may be omitted from the assessment of the following members:

- 1) internal longitudinal girders where the distance between centre lines of the outermost girders is less than 10m;
- 2) longitudinal edge girders outside the carriageway where the distance between the kerb line and the centre of the girder is greater than 0.5m;
- 3) transverse members being assessed for bending effects;
- 4) members with spans greater than 6m being assessed for shear effects.

5.24.4 Where the critical carriageway loading effect is due to single axle loading or ALL model 1, the equivalent static live load,  $W_L$ , should be taken as the wheel loads applied in each lane.

- 5.24.5 Where the critical loading effect is due to the combined uniform and knife-edge loading, the equivalent static live load,  $W_L$ , should be determined from the uniform and knife edge loading applied to each notional lane, converted into two longitudinal line loads applied at 1.8m transverse spacing, and two point loads applied at 1.8m transverse centres.
- 5.24.6 The equivalent longitudinal line loads should be derived by dividing the ALL model 2 UDL for each notional lane by 2.
- 5.24.7 The equivalent point loads should be derived by dividing the ALL model 2 KEL for each notional lane by 2.
- 5.24.8 The transverse positions of the equivalent line loads and point loads should be coincident.
- 5.25 The equivalent static live load shall be applied to each lane to give the worst loading effect on the member or element under consideration.
- 5.26 The equivalent static live load shall be adjusted for centrifugal effects in accordance with Figure 5.26.

Figure 5.26 Application of centrifugal loads

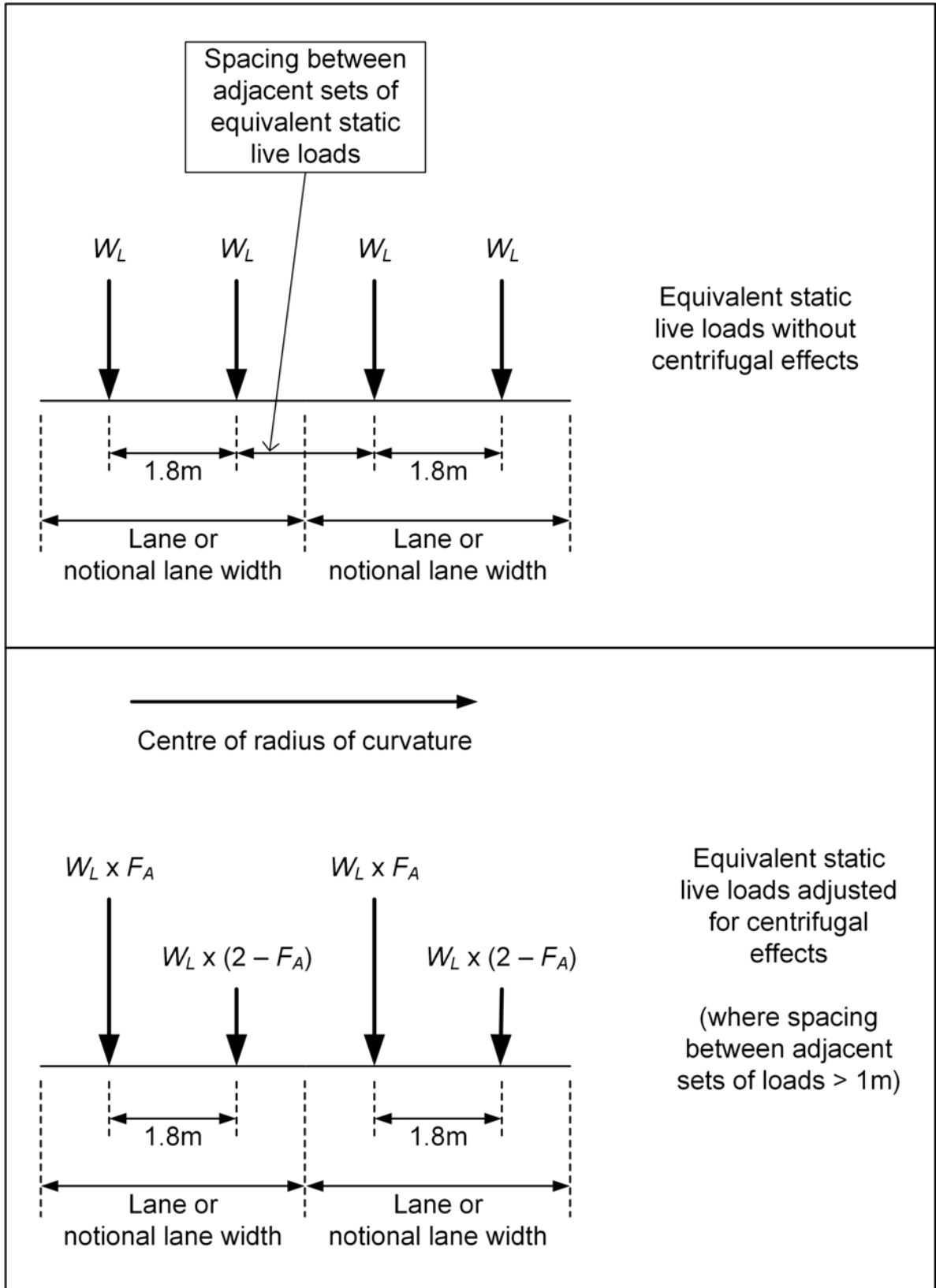

5.26.1

Where it is not possible to fit the equivalent static live load within a lane or notional lane and maintain a 1m spacing from wheel centres of adjacent sets of equivalent static live load, centrifugal effects should be applied to alternating lanes, and omitted in the other lanes by applying the equivalent static live load

without adjustment in those lanes.

**Accidental vehicle loading**

- 5.27 Members supporting central reserves, outer verges and footways that are not protected from vehicular traffic by an effective barrier shall be assessed for accidental vehicle loading.
- 5.27.1 Road restraint systems that have a higher containment level or a very high containment level in accordance with TD 19 [Ref 24.] may be assumed to be effective barriers.
- 5.27.2 Accidental vehicle loading should not be combined with footway loading.
- 5.27.3 The characteristic accidental vehicle loading for cantilevered members should be determined in accordance with Figure 5.27.3 and Table 5.27.3.

**Table 5.27.3 Characteristic accidental wheel loads for cantilevered members**

Assessment live loading level	W <sub>1</sub> (kN)	W <sub>2</sub> (kN)
Normal traffic	100	60
26 tonnes	100	40
18 tonnes	100	10
7.5 tonnes	50	10
3 tonnes	25	0
Fire engines group 1	60	10
Fire engines group 2	30	20

**Figure 5.27.3 Accidental vehicle loading arrangement for cantilevered members**

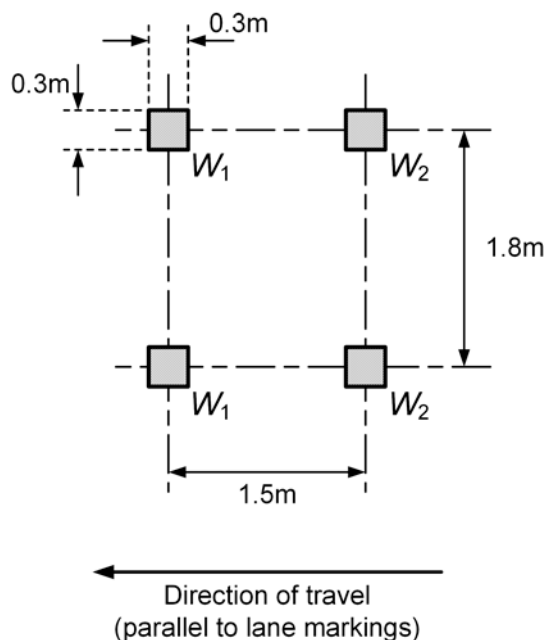

- 5.27.4 The characteristic accidental vehicle loading arrangement for non-cantilevered members should consist of a single vehicle, applied in accordance with the the provisions of ALL model 1, including the impact factor and assuming low traffic flow.
- 5.27.5 Where there is a barrier in place that does not provide a higher containment or very high containment level in accordance with TD 19 [Ref 24.], the characteristic accidental vehicle loading should comprise a single vehicle from ALL model 1, with an impact factor of 1.0 and assuming low traffic flow.

5.28 The accidental vehicle loading shall be placed to produce the most adverse effect on the member or element under consideration.

### Footway loading

5.29 Elements supporting footways or cycleways shall be assessed for the most severe effects arising from the application of:

- 1) accidental vehicle loading;
- 2) pedestrian loading.

5.30 The pedestrian ALL model shall not be used in the following cases, where it is not valid:

- 1) elements supporting footways only, where the loaded length is greater than 36m and crowds are expected;
- 2) structures where the loaded length is greater than 400m;
- 3) elements supporting both footways and carriageways, where crowds are expected.

5.31 Where the pedestrian ALL model is not valid, or where a more accurate assessment is proposed, the pedestrian loading shall be agreed with the Overseeing Organisation.

*NOTE Design load models for pedestrian loading are provided in BS EN 1991-2 [Ref 11.1].*

### Pedestrian ALL model

5.32 The pedestrian ALL model shall comprise a uniformly distributed load as defined in Table 5.32a, as modified by the pedestrian live load factor and width factor in Table 5.32b.

**Table 5.32a UDL for pedestrian live loading model**

Loaded length, $L$ (m)	Pedestrian live load, $P$ (kN/m <sup>2</sup> )
$0 < L \leq 36$	5.0
$36 < L \leq 50$	$\frac{336}{L^{0.67}} \cdot \frac{10}{L+270} \cdot 5.0$
$50 < L \leq 400$	$\frac{36}{L^{0.1}} \cdot \frac{10}{L+270} \cdot 5.0$

**Table 5.32b Pedestrian live load factors and width factors**

Situation	Pedestrian live load factor	Width factor
Elements supporting footways only	1.0	See Table 5.33c
Main structural member supporting two or more notional traffic lanes in addition to a footway	0.8	See Table 5.33c
Elements supporting both footways and a carriageway on bridges with two footways where the load combination being considered is such that only one footway is loaded	0.8	1.0
Any other situation where an element supports both footways and a carriageway	0.8	See Table 5.33c

**Table 5.32c Width factors**

Footway width	Width factor
0m to 2m	1.00
3m	0.95
4m	0.89
5m	0.85
6m	0.83
Note: Interpolation is permitted	

- 5.32.1 The pedestrian live load should be applied in the parts of the footway to cause the most severe effect on the member or element under consideration.

### Wind actions

- 5.33 Where the assessment includes wind actions, the characteristic wind actions shall be defined using a representative model.

- 5.33.1 Where all of the following conditions are satisfied, the characteristic actions for wind loading may be determined using a simplified wind model consisting of a pressure of 6kN/m<sup>2</sup> applied to the vertical projected area of the bridge or structural element under consideration, neglecting areas where the load is beneficial:

- 1) the structure is a highway bridge of concrete slab, or beam and slab construction;
- 2) the structure has a span of 20m or less;
- 3) the structure has a width of 10m or more;
- 4) the structure is at normal height above ground.

- 5.33.2 Where a simplified wind model is not valid, or a more detailed assessment is proposed, the characteristic actions for wind loading may be determined in accordance with the model given in Appendix D.

*NOTE 1 The wind loading model given in Appendix D allows the effects of wind actions to be simulated using static analytical procedures.*

*NOTE 2 The wind loading model given in Appendix D does not account for the effects of any dynamic responses due to turbulence or aerodynamic effects.*

*NOTE 3 The wind loading model given in Appendix D is suitable for highway and rail bridges of up to 200m span and footbridges of up to 30m span.*

### Thermal actions

- 5.34 Where the assessment includes thermal actions, the characteristic thermal actions shall be defined using a representative model.

- 5.34.1 The characteristic actions for thermal loading on bridge superstructures may be determined in accordance with the model given in Appendix D.

*NOTE 1 The thermal loading model given in Appendix D is not suitable for modelling the effects of changes in temperature on bridge piers, towers or cables.*

*NOTE 2 Coefficients of thermal expansion for construction materials are provided in Section 4.*

### Longitudinal traffic loading

- 5.35 Where the assessment includes longitudinal traffic loading, the characteristic longitudinal actions arising from the following shall be defined using a representative model:

- 1) traction or braking of vehicles;
- 2) accidental skidding of vehicles.

5.35.1 The characteristic longitudinal actions arising from traction or braking of normal traffic may be taken from Equation 5.35.1 and applied in one lane only to an area one lane in width over the loaded length.

**Equation 5.35.1 Longitudinal braking or traction load**

$$Q_L = \min(8L + 250, 750)$$

where:

$Q_L$  is the braking or traction load, in kN

$L$  is the loaded length, in m

5.35.2 The characteristic longitudinal actions arising from accidental skidding of normal traffic may be taken as a single point load of magnitude 300kN, applied to the surface of the carriageway, acting in any horizontal direction.

## 6. Structural analysis

### Analysis methods

- 6.1 The distribution of load effects in a bridge shall be assessed using a global analysis model.
- 6.1.1 The choice of the analysis method should be based on the structural form and the required degree of accuracy.
- 6.2 The local effects of wheel loads on the bridge shall be assessed.
- 6.3 The method of analysis shall be selected based on the limit state being assessed.
- 6.3.1 Linear elastic analysis methods may be used for all limit states.
- 6.3.2 Plastic analysis may be used for the ultimate limit state where permitted by the relevant assessment documents, for example BD 44 [Ref 6.N] , BD 56 [Ref 8.N] and BD 61 [Ref 5.N], and where the materials and components have sufficient deformation capacity.
- 6.4 The effects of deterioration in the condition of the structure shall be included in the analysis method.

*NOTE Requirements for the assessment of deterioration for specific materials and structure types are provided in the relevant assessment documents, for example BD 44 [Ref 6.N], BD 56 [Ref 8.N] and BD 61 [Ref 5.N].*

- 6.5 The analysis shall be carried out in accordance with the requirements in the relevant assessment documents, for example BD 44 [Ref 6.N] , BD 56 [Ref 8.N] and BD 61 [Ref 5.N], including material-specific aspects such as the calculation of member stiffnesses, the effects of cracking and deterioration.

### Effective spans

- 6.6 Effective spans shall be calculated based on an assessment of the position of the centroids of the support reactions.
- 6.6.1 Where there are no bearing stiffeners and the member rests directly on brick, masonry, concrete or granite, the effective span should be taken as the distance between the centroids of bearing pressure diagrams, assuming the reaction is linearly distributed from a maximum at the front edge of the support to zero at the back of the bearing area.
- 6.6.2 Where the support is brick or masonry, the length of the bearing area should be taken as no greater than the depth of the member.
- 6.6.3 Where the support is concrete or granite, the length of the bearing area should be taken as no greater than one quarter of the depth of the member.
- 6.6.4 The effective span of a member framing into support members should be taken as the distance between the shear centres of the supporting members.

### Dispersal of loads for decks other than troughs

- 6.7 Where dispersal of wheel loads through fill and other materials on the structure is included in the assessment, the analysis of the dispersal shall be dependent on the properties of the materials and their compaction.
- 6.7.1 Dispersal of wheel loads through surfacing and well compacted fill materials may be taken as 2 vertically to 1 horizontally from the edge of the wheel contact area.
- 6.7.2 Dispersal of nominal wheel loads through concrete slabs may be taken as 1 vertically to 1 horizontally from the edge of the wheel contact area.
- 6.7.3 Dispersal of wheel loads may be included to a depth of:
  - 1) for hogging plates: the highest part of the plate;

- 2) for jack arches: the level of the mid-depth of the arch ring at the crown;
- 3) for reinforced concrete slabs: the mid-depth of the slab.

6.8 No allowance for the dispersal of UDL and KEL shall be made.

**Dispersal and distribution of loads through trough decks**

**General**

6.9 The loading on trough decks shall be based on the orientation of the troughs relative to the direction of the carriageway, as illustrated in Figure 6.9.

**Figure 6.9 Longitudinal transverse trough decks**

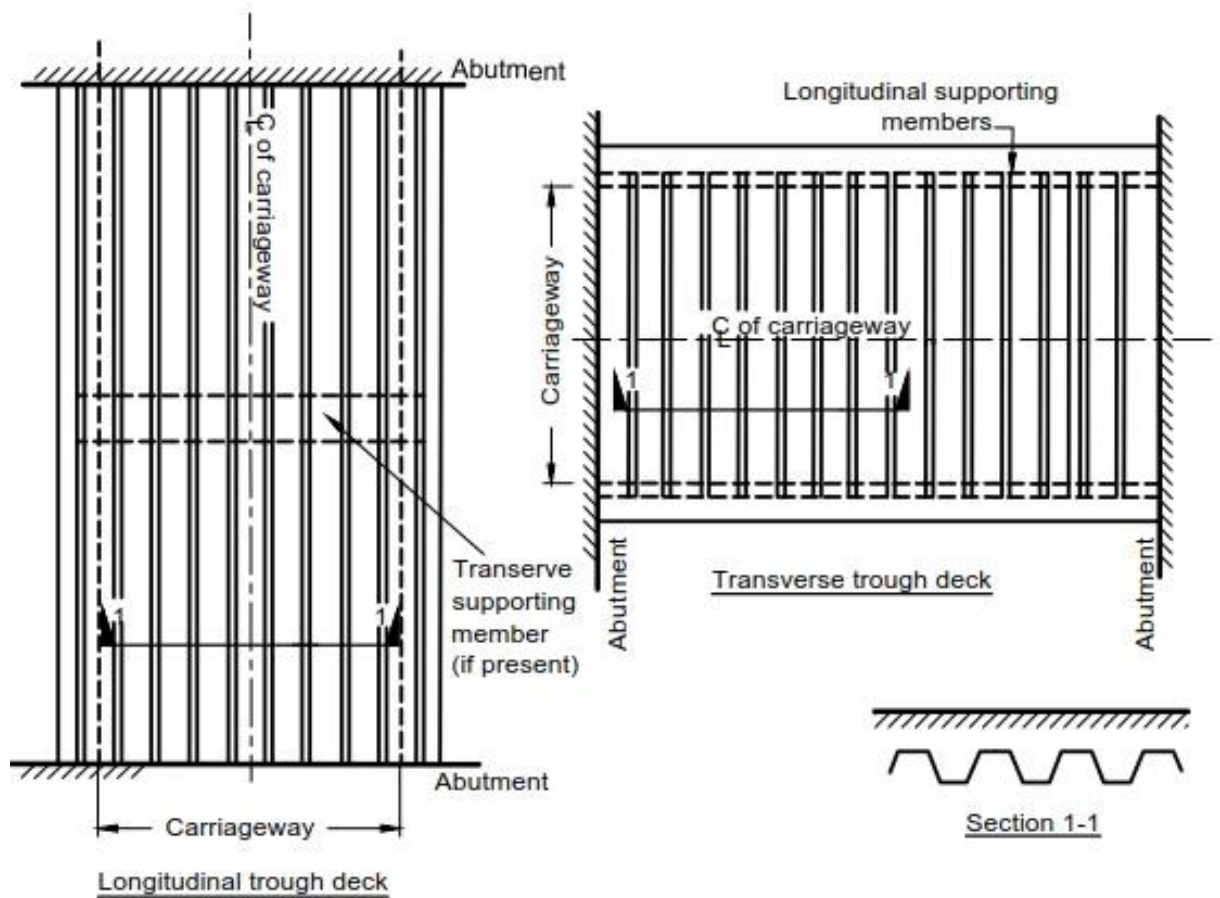

**NOTE 1** In longitudinal trough decks, the troughing runs parallel to the direction of the carriageway and spans between supporting transverse members or abutments, as shown in Figure 6.9.

**NOTE 2** In transverse trough decks, the troughing runs at a right angle to the direction of the carriageway and spans between supporting longitudinal members, as shown in Figure 6.9.

**Loads for longitudinal trough decks**

- 6.10 Where the deck is a longitudinal trough deck, the UDL component of ALL model 2 shall be replaced by two longitudinal strip loads, applied over a transverse width of 0.3m with a 1.8m transverse spacing between the centre lines of the strips, with the load split 50:50 between the strips.
- 6.11 Where the deck is a longitudinal trough deck, the KEL component of ALL model 2 shall be replaced by two wheel loads, applied over a 0.3m x 0.3m square contact area with a 1.8m transverse spacing between their centres, with the load split 50:50 between the wheels.

- 6.12 One set of two longitudinal strip loads and one set of two wheel loads shall be applied per notional lane and positioned within the lane to give the most adverse loading effect.
- 6.13 The transverse positions of the strip loads and wheel loads shall be coincident.
- 6.14 The minimum transverse separation between two adjacent sets, measured between the centre lines of the longitudinal strip loads, shall be 0.7m.

**Loads for transverse trough decks**

- 6.15 Transverse troughs decks shall be assessed for the single axle load in accordance with Section 5, multiplied by the relevant enhancement factor given in Table 6.15.

**Table 6.15 Transverse troughing enhancement factors**

Assessment live loading	Depth from road surface to top of troughing (m)									
	0.2	0.3	0.4	0.5	0.6	0.7	0.8	0.9	1.0	1.5
Normal traffic	1.00	1.04	1.08	1.13	1.17	1.21	1.25	1.30	1.34	1.55
26 tonnes	1.00	1.04	1.08	1.13	1.17	1.21	1.25	1.30	1.34	1.55
18 tonnes	1.00	1.04	1.08	1.13	1.17	1.21	1.25	1.30	1.34	1.55
7.5 tonnes	1.00	1.00	1.02	1.03	1.05	1.06	1.07	1.08	1.09	1.10
3 tonnes	1.00	1.00	1.00	1.00	1.00	1.00	1.00	1.00	1.00	1.00
FE groups one & two	1.00	1.00	1.00	1.00	1.00	1.00	1.03	1.06	1.09	1.16

NOTE 1 Linear interpolation can be used for intermediate values.

NOTE 2 Enhancement factors given in Table 6.15 depend on the depth from the road surface to the top of the troughing and allow for the presence of other axles on the vehicles including bogies.

- 6.15.1 Where loading from a single wheel gives a more critical effect than a single axle load, the enhancement factor may be taken as 1.0 on the single wheel load.

**Dispersal and distribution of loads in trough decks**

- 6.16 For trough decks the distribution of load effects shall be estimated for assessment using a representative model, taking into account:

- 1) the condition of the troughing as determined in the inspection for assessment;
- 2) the location of the loads relative to the edge of the trough.

- 6.16.1 For longitudinal and transverse troughs, where the span of the bridge is more than 4m and the carriageway is at least 3 webs of troughing away from the edge of the trough, the distribution of load effects may be based on Figure 6.16.1.

**Figure 6.16.1 Dispersal and distribution of load through troughing**

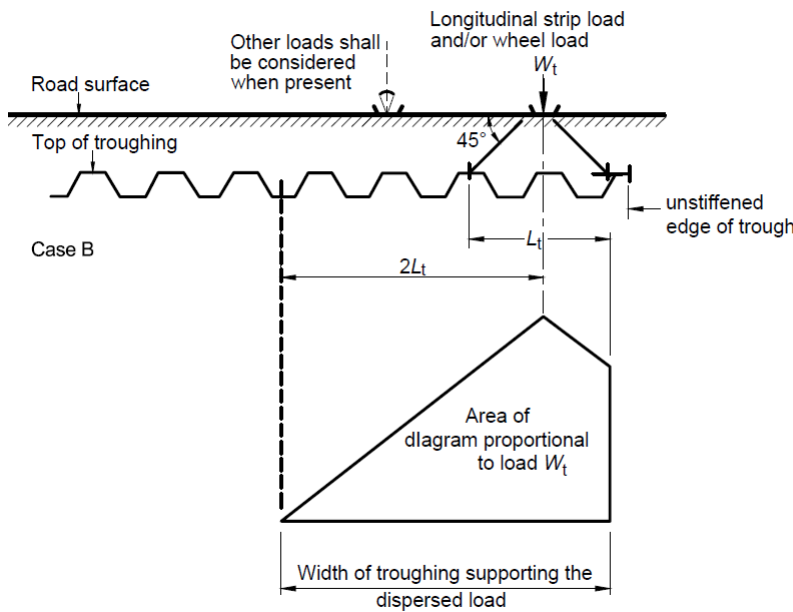
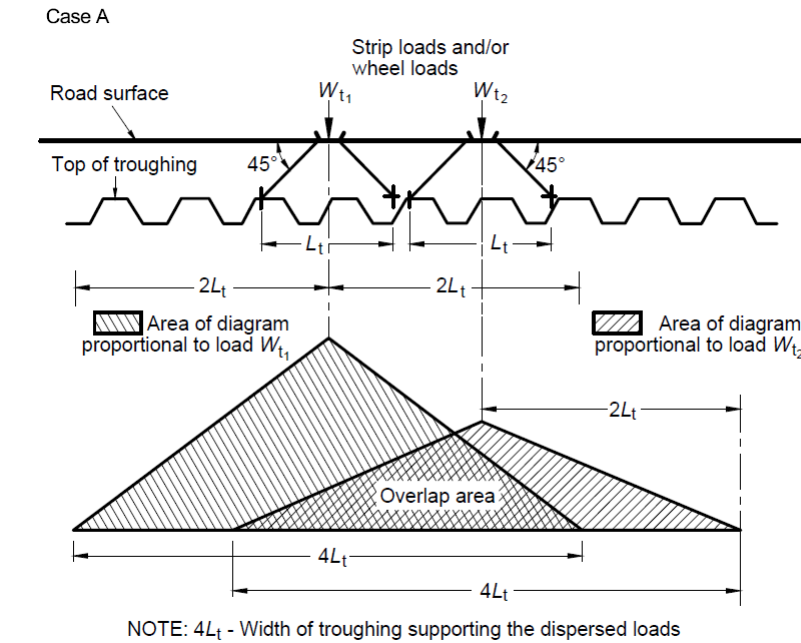

**NOTE 1** In Figure 6.16.1, the proportion of each load taken by individual troughs is given by the ratio obtained by dividing the area of the portion of the distribution diagram that corresponds to the trough width by the total area of the diagram for each load. Load effects are superposed where the diagrams overlap.

**NOTE 2** In Figure 6.16.1, case B can be used to model troughs adjacent to an area exhibiting poor condition or distress, or troughs that do not extend far enough to use case A.

6.16.2 Figure 6.16.1 should not be used for transverse troughs with a fill depth greater than 300mm.

6.16.3 In cases where Figure 6.16.1 is not used, the distribution may be modelled using a grillage analysis, with each web and its associated flanges modelled individually.

6.16.4 When using a grillage analysis, in areas of the deck where the transverse bending moment is sagging, the transverse bending rigidity may be enhanced in alternating elements to take account of the

composite action of the concrete trapped within the webs.

- 6.16.5 Where the edge of the outside trough is stiffened or otherwise supported, this detail should be included in the analysis model.

## 7. Assessment of masonry arches

### Limit state verifications for masonry arches

7.1 At the ULS, the assessment resistance for masonry arches shall be verified to exceed the assessment load effects in accordance with the basis of assessment set out in Section 3, together with the requirements in this section regarding:

- 1) application of actions;
- 2) material partial factor and condition factor;
- 3) structural analysis.

7.2 The assessment of masonry arches shall confirm that there is a sufficient live load capacity factor to avoid the traffic loading reaching levels that can cause further distress and reduce the life of the arch, according to Equation 7.2.

#### Equation 7.2 Required live load capacity factor to avoid further distress

$$C \geq C_{\min}$$

where:

$C$  is the live load capacity factor, defined as the additional factor that can be applied to the assessment traffic actions (in addition to the partial factors as defined in Section 3) without causing the assessment action effects to exceed the assessment resistance at ULS.

$C_{\min}$  is the value of live load capacity factor that corresponds to the loads frequently reaching levels that could result in further distress and reduce the life of the arch, taken as  $C_{\min} = 1.2$  for normal and restricted traffic or  $C_{\min} = 1.5$  for abnormal traffic.

**NOTE 1** The values for  $C_{\min}$  have been derived based on the formulation  $C_{\min} = \frac{\psi \gamma_{fL,SLS}}{K \gamma_{f3} \gamma_{fL,ULS}}$  where  $K$  is the proportion of the ULS resistance where further distress could occur, assumed here to be  $K = 0.5$ , and  $\psi$  is the proportion of the SLS traffic load that would be frequently experienced, taken as  $\psi = 0.75$  for normal or restricted traffic. For abnormal traffic,  $\psi$  is taken as  $\psi = 1.0$  to align with previous practice. The values of  $\gamma_{fL,SLS}$  and  $\gamma_{fL,ULS}$  are the partial factors for traffic loading given in Appendix A, and  $\gamma_{f3}$  is the value for masonry arches given in Section 3.

**NOTE 2** In previous versions of this document  $C_{\min}$  was included within the ULS partial factor for traffic on arches.

### Application of actions for masonry arch assessment

7.3 The assessment load effects in the arch shall be assessed, including the effects of:

- 1) dead loads;
- 2) superimposed dead loads;
- 3) traffic actions.

**NOTE** Dead loads and superimposed dead loads can have a relieving effect on masonry arches. Section 3 defines lower partial factors for permanent actions that have a relieving effect.

7.3.1 The characteristic traffic actions for normal traffic on masonry arches should be represented by the axle loads for the single axle, double axle bogie or triple axle bogies listed in Table 7.3.1a, applied using the same wheel dimensions, wheel spacings and lane widths as for ALL model 1 as defined in Section 5, modified by:

- 1) the conversion factors in Table 7.3.1b;
- 2) the impact factors, lane factors and traffic flow factors as given for ALL model 1 in Section 5.

**Table 7.3.1a Authorised axle loads and spacings for normal and restricted traffic**

Assessment live loading level	Single axle	Double axle bogie		Triple axle bogie	
	Axle load (tonnes)	Axle load (tonnes)	Range of axle spacing $s$ (m)	Axle load (tonnes)	Range of axle spacing (m)
Normal traffic	11.5	8	$1.00 \leq s < 1.30$	7	$s < 2.60$
		9.5	$1.30 \leq s < 1.80$	8	$s \geq 2.60$
		10	$s \geq 1.80$	-	-
33 tonnes	11.5	9.5	$s \geq 1.30$	-	-
26 tonnes	11.5	9.5	$s \geq 1.30$	-	-
18 tonnes	11.5	-	-	-	-
Fire engines group 1	10	-	-	-	-
13 tonnes	9	-	-	-	-
10 tonnes	7	-	-	-	-
7.5 tonnes	5.5	-	-	-	-
Fire engines group 2	5	-	-	-	-
3 tonnes	2	-	-	-	-

**Table 7.3.1b Characteristic axle weight conversion factors for masonry arches**

Loading	Location	Conversion factors	
		No axle lift-off	With axle lift-off
Single axle	-	1.0	-
Double axle bogie <sup>[1]</sup>	Axle 1	1.0	1.5
	Axle 2	1.0	0.5
Triple axle bogie <sup>[2]</sup>	Axle 1	1.0	1.5
	Axle 2 (middle axle)	1.0	1.0
	Axle 3	1.0	0.5

Note 1: Conversion factor values for axles 1 and 2 of the double-axle bogie are interchangeable.  
Note 2: Conversion factor values for axles 1 and 3 of the triple-axle bogie are interchangeable.

7.3.2 Axle lift-off should be assessed where there are any of the following conditions:

- 1) a vertical road alignment with significant changes from positive to negative gradient over a short distance (e.g. a humped back bridge);
- 2) arch located at the bottom of a hill or on a straight length of road where approach speeds are likely to be high;
- 3) irregularities in road surface on the arch.

7.3.3 Where the assessment is being carried out specifically for bogies with air or fluid suspension, axle lift-off may be omitted.

7.3.4 Masonry arches with spans over 20m should be assessed for normal traffic as represented by ALL model 2 based on a loaded length equal to half of the arch span.

**NOTE** ALL model 2 is applied separately from the single axle, double axle and triple axle bogies that are applicable for all spans. Both load models are applicable for spans over 20m.

7.3.5 Wheel loads should be dispersed through the fill at an angle 2 vertically to 1 horizontally.

### Material partial factor and condition factor for masonry arches

7.4 The effects of material degradation and defects in condition shall be included in the assessment of arches, through the following:

- 1) the value of the partial factor for material strength  $\gamma_m$  ;
- 2) the value of the condition factor  $F_c$  ;
- 3) the analysis model.

7.4.1 Where the effects of material degradation and defects in condition are accounted for through the analysis model or through the condition factor  $F_c$  , the partial factor for material strength  $\gamma_m$  should be taken as 1.0.

7.4.2 Where a defect is included in the analysis model, the effect of the defect should not be included in the value of  $F_c$  .

7.5 Where a condition factor is used, the value of  $F_c$  shall be determined based on the inspection for assessment.

**NOTE** *Inspection for assessment is covered in Section 2.*

7.5.1 The condition factor  $F_c$  should be taken from Equation 7.5.1a:

#### Equation 7.5.1a Condition factor

$$F_c = F_{cM}F_j$$

where:

$F_{cM}$  Arch barrel condition factor based on the guidance in Table 7.5.1a with  $0 \leq F_{cM} \leq 1.0$

$F_j$  Joint factor obtained from Equation 7.5.1b

#### Equation 7.5.1b Joint factor

$$F_j = F_w F_d F_{mo}$$

where:

$F_w$  Joint width factor obtained from Table 7.5.1b

$F_d$  Joint depth factor obtained from Table 7.5.1c

$F_{mo}$  Mortar factor obtained from Table 7.5.1d

**Table 7.5.1a Arch barrel condition factor**

Type of cracks	Condition/cause of cracks	Arch barrel condition factor $F_{cM}$
Longitudinal cracks that are not already included in the analysis model	Longitudinal cracks can be caused by differential settlement in the abutments. Wide longitudinal cracks can indicate that the barrel has broken up into independent sections. <sup>[1]</sup>	0.4 - 0.6 <sup>[1]</sup>
Lateral cracks or permanent deformation of the arch that are not already included in the analysis model	Lateral cracks or permanent deformations can be caused by partial failure of the arch or movement at the abutments. These faults can be accompanied by a dip in the parapet.	0.6 - 0.8
Diagonal cracks <sup>[3]</sup> that are not already included in the analysis model	Diagonal cracks can start near the sides of the arch at the springings and spread up towards the centre of the barrel at the crown.	0.3 - 0.7
Cracks in spandrel walls near quarter points that are not already included in the analysis model	Cracks in spandrel walls near the quarter points can indicate flexibility of the arch barrel over the centre half of the span.	0.8
Only minor defects that are not already included in the analysis model, with no significant cracking or deformation	Minor defects can include dampness, minor cracks or gouging to a few individual stones.	0.9
<p>Note 1: If the indications are that the barrel is broken up into 1m or less wide sections and this effect is not included in the analysis model, then <math>F_{cM} = 0.4</math>.</p> <p>Note 2: The value of <math>F_{cM}</math> is selected based on the worst type of defect present, and not by multiplying the factors for several separate defects.</p> <p>Note 3: Further guidance regarding the effects of diagonal cracks can be found in [Ref 8.].</p> <p>Note 4: Further guidance on the arch barrel factor can be found in [Ref 4.].</p>		

**Table 7.5.1b Joint width factor**

Width of joint	Joint width factor $F_w$
Joints with widths up to 6mm	1.0
Joints with widths between 6mm and 12.5mm	0.9
Joints with widths over 12.5mm	0.8

**Table 7.5.1c Joint depth factor**

Construction of joint	Joint depth factor $F_d$
Pointed joints in good condition	1.0
Unpointed joints, pointing in poor condition and joints insufficiently filled up to 12.5mm from the edge	0.9
Joints with 10% of the thickness of the barrel insufficiently filled <sup>[2]</sup>	0.8
Joints insufficiently filled for more than 10% but less than 30% of the thickness of the barrel	$\left(\frac{d-d_j}{d}\right)^2$

Note 1: In the table,  $d$  is the arch barrel thickness; and  $d_j$  is the depth of missing mortar in the joint.  
 Note 2: Interpolation between 0.8 and 0.9 can be carried out.  
 Note 3: Where the barrel thickness is reduced in the analysis by the amount of missing mortar, the depth factor is 1.0.  
 Note 4: Where the joint is insufficiently filled for more than 30% of the thickness, the depth factor is based on judgement, but not greater than the value given for an insufficiently filled joint for 30% of the thickness.  
 Note 5: Guidance on the estimation of the joint depth factor can be found in [Ref 1.] and [Ref 4.].

**Table 7.5.1d Mortar factor**

Condition of joint	Mortar factor $F_{mo}$
Mortar in good condition	1.0
Loose or friable mortar	0.9

7.6 Where the combination of defects in an arch are judged to pose an immediate risk, the structure shall be managed as an immediate risk structure according to the requirements of BD 79 [Ref 9.N].

*NOTE 1 A very low condition factor can indicate that the arch is an immediate risk structure.*

*NOTE 2 The condition factor for an arch can often be improved by carrying out minor repairs.*

### Analysis of masonry arches

7.7 The method of analysis for arch assessment shall be selected and defined in the AIP for the assessment.

*NOTE 1 A method for the assessment of jack arches is provided in BD 61 [Ref 5.N].*

*NOTE 2 The assessment of spandrel walls, wing walls and foundations is covered in CS 459 [Ref 4.N].*

7.7.1 The analysis model for an arch should include the arch barrel and piers.

7.7.2 The analysis model for an arch may include:

- 1) the dispersal of loading through soil;
- 2) the restraint to the movement of the arch barrel provided by earth pressures.

7.7.3 Spandrel walls should not be assumed to provide support or strength to the arch barrel.

7.7.4 Where the arch barrel includes longitudinal cracks that divide the barrel into sections, the critical section of arch barrel between the longitudinal cracks should be analysed and assessed for the effects of the assessment loading.

7.7.5 Where an arch barrel comprises multiple rings and there is evidence of ring separation or where there is a risk of ring separation occurring, the effect of the ring separation should be included in the assessment of resistance.

**NOTE** The inter-ring bond strength can often be insufficient to prevent ring separation at ULS even where there is no historic evidence of ring separation occurring in service. This is particularly true in longer spans. For further guidance see [Ref 28.].

7.7.6 Where the analysis model is 2-dimensional, the effective width of the arch should be taken as the minimum of the following:

- 1) the width of the arch barrel;
- 2) the width between longitudinal cracks that divide the arch barrel into sections;
- 3) the combined effective width based on the position of the applied wheel loads in accordance with Figure 7.7.6.

**Figure 7.7.6 Combined effective width**

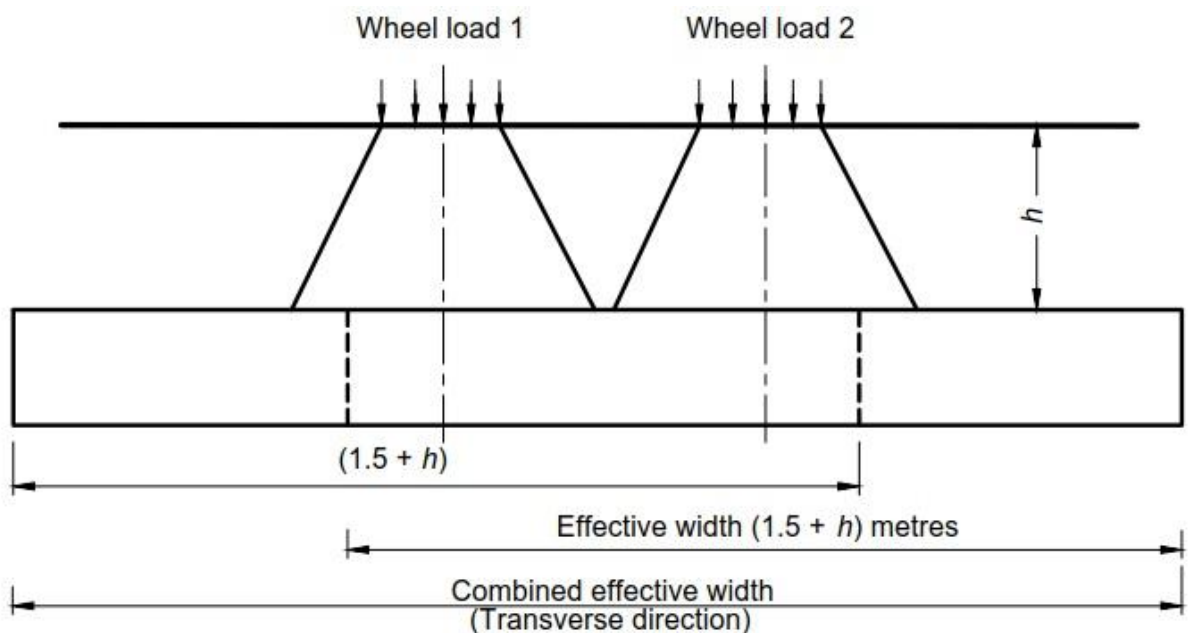

**NOTE** In the figure for effective width  $h$  is the depth of the fill at the point under consideration.

7.7.7 Where the analysis model does not account for skew, and the masonry arch has a constant skew angle and bridge width, the effect of skew angles up to 30 degrees may be assessed using Equation 7.7.7.

**Equation 7.7.7 Effect of skew on arch assessment**

$$R_{skew} = \left(\frac{b}{w}\right)^2 R_{square} \quad \text{for } 0^\circ \leq \alpha \leq 30^\circ$$

where:

- $R_{skew}$  is the assessment resistance of a skew arch with skew span  $L$
- $R_{square}$  is the assessment resistance of a square arch with span  $L$
- $b$  is the abutment width
- $w$  is the bridge width
- $\alpha$  is the skew angle (angle between the lines defining  $b$  and  $w$ )

7.7.8 Methods of analysis for arch assessment may comprise one or more of the following:

- 1) mechanism analysis;

- 2) equilibrium-based analysis;
- 3) non-linear finite element analysis;
- 4) the modified MEXE method.

### **Mechanism analyses**

7.8 Where a mechanism analysis is used for arch assessment, the assessment resistance shall be determined by evaluating the lowest load that would cause any compatible failure mechanism to form.

*NOTE 1 Software-based optimisation procedures can identify the most critical mechanism.*

*NOTE 2 Mechanisms can include:*

- 1) the development of hinges in the arch barrel or piers and rotation of the arch sections between the hinges;
- 2) sliding in joints.

*NOTE 3 More complicated mechanisms are possible in multi-ring arch barrels [Ref 28.I].*

*NOTE 4 Further information on mechanism analysis of arches can be found in [Ref 3.I] and [Ref 29.I].*

*NOTE 5 Some software packages allow both mechanism analyses and equilibrium-based analyses to be carried out together.*

7.9 Where a mechanism analysis is used, it shall be verified that the line of compressive thrust for the critical mechanism remains entirely within the arch barrel between hinge positions.

### **Equilibrium-based analysis**

7.10 Where an equilibrium-based analysis is used for arch assessment, the assessment resistance shall be determined by:

- 1) determining a set of internal stresses or lines of compressive thrust that are in equilibrium with the assessment actions;
- 2) verifying that the stresses do not exceed the strength of the masonry;
- 3) verifying that the lines of compressive thrust remain entirely within the arch barrel, or within any additional structural backing material.

*NOTE 1 Guidance on determining the strength of masonry is given in Section 4.*

*NOTE 2 Further information on equilibrium-based analysis for masonry arches can be found in [Ref 33.I].*

*NOTE 3 Elastic solutions can be obtained using Castigliano-type methods, based on minimum elastic energy principles. Further guidance on this method can be found in [Ref 2.I].*

### **Non-linear finite element analysis**

7.11 Where a non-linear finite element analysis is used for arch assessment, the assessment resistance shall be determined from an analysis of the non-linear behaviour of the structure and its interaction with the soil, in response to the application of the assessment actions.

7.11.1 Non-linear finite element analysis may include:

- 1) the definition of non-linear material properties for the masonry;
- 2) the definition of non-linear material properties for the soil;
- 3) analysis of geometrically non-linear behaviour.

7.11.2 The modelling methodology and assumptions for non-linear finite element analysis, including the values or ranges of values for all input parameters to the non-linear material models, should be confirmed, validated and agreed with the Overseeing Organisation.

*NOTE 1 The assessment of arches using non-linear finite element analysis can be sensitive to the modelling of tensile strength. High values of tensile strength can provide an unconservative assessment of stiffness and resistance.*

*NOTE 2 Further guidance on finite element analysis of masonry arch bridges can be found in [Ref 13.I].*

**The modified MEXE method**

7.12 Where the modified MEXE method is used for arch assessment, the resistance shall be determined using Appendix E.

7.13 The modified MEXE method shall not be used for any of the following:

- 1) multi-span arches;
- 2) multi-ring arches where ring separation is likely to limit the capacity of the structure;
- 3) arches with deformed profiles;
- 4) arches with span lengths less than 5m;
- 5) arches with span lengths greater than 18m;
- 6) arches with a depth of the fill at the crown that exceeds the thickness of the arch barrel;
- 7) flat arches and arches with a span/rise ratio that exceeds 8;
- 8) arches with a skew angle that exceeds 35 degrees.

*NOTE The modified MEXE method is based on Pippard's equations. Further information on Pippard's equations and methods can be found in [Ref 26.I].*

## 8. Assessment of cast iron

8.1 Cast iron members shall be assessed by verifying that the stresses do not exceed permissible values.

8.1.1 Where cast iron struts are adequately braced, they may be assessed by limiting the compressive force using Equation 8.1.1:

**Equation 8.1.1 Limiting compressive force in cast iron struts**

$$P_c = \left( \frac{0.2Af_c}{1 + F_{ef} \cdot \frac{L_s^2}{1600K_r^2}} \right) \cdot 10^{-3}$$

where:

- $P_c =$  limiting compressive force in the strut (kN)
- $f_c =$  compressive yield stress taken as 555 MPa
- $A =$  cross-section area (mm<sup>2</sup>)
- $L_s =$  length (mm)
- $K_r =$  minimum radius of gyration (mm)
- $F_{ef} =$  end fixity factor given in Table 8.1.1

**Table 8.1.1 Values of end fixity factor**

End condition	$F_{ef}$
Both ends pin jointed	1
One end fixed, one end pin jointed	0.5
Both ends rigidly fixed	0.25
One end fixed, one end entirely free	4

8.1.2 For the analysis of the effects of live loading on cast iron girders in bending, the section modulus of the cast iron girders may be increased by the section modulus factor  $F_I$  given in Equation 8.1.2, provided the following conditions are met:

- 1) the girders are known to be firmly embedded in well consolidated filling material other than pure sand or pure clay;
- 2) there are no services in the carriageway which would decrease the support rendered by the fill;
- 3) the probability of removal of the embedment material is low, or it can be confirmed that any openings made in the carriageway that affect the assessment assumptions are backfilled with concrete.

**Equation 8.1.2 Section modulus factor**

$$F_I = \min \left( 2.0; \frac{D}{d} \right)$$

where:

- $F_I$  is the section modulus factor
- $D$  is the overall depth of the carriageway minus a surfacing material thickness assumed to be 75mm
- $d$  is the depth of the bare girder at midspan

**NOTE 1** The section modulus factor does not apply to cast iron troughs.

**NOTE 2** Further information on the section modulus factor can be found in [Ref 34.I].

8.2 Deterioration in the condition of cast iron shall be included in the assessment.

8.2.1 Where the effect of the deterioration is included explicitly in the assessment, for example through the use of reduced cross section dimensions, the condition factor  $F_c$  should be taken as 1.0.

**Permissible stresses in cast iron**

8.3 The total compressive stress in cast iron shall not exceed 154 MPa.

8.4 The total tensile stress in cast iron shall not exceed 46 MPa.

8.5 The stress due to traffic loads  $\sigma_{tr}$  shall not exceed the tensile stress limit  $f_{p1}$  as described by Equation 8.5.

**Equation 8.5 Tensile stress limit for traffic loading in cast iron**

$$\sigma_{tr} \leq f_{p1}$$

where:

$$f_{p1} = 25 - 0.44\sigma_g \quad \text{when } \sigma_g > -16 \text{ MPa}$$

$$f_{p1} = 20 - 0.76\sigma_g \quad \text{when } \sigma_g \leq -16 \text{ MPa}$$

$\sigma_g$  is the stress due to permanent loads,  
all stresses are in MPa,  
and tensile stress is positive.

**NOTE** The limitations in Equation 8.5 provide assurance against fatigue.

8.6 The compressive stress due to traffic loads only shall not numerically exceed the compressive stress limit as described by Equation 8.6.

**Equation 8.6 Compressive stress limit for traffic loading in cast iron**

$$-\sigma_{tr} \leq -f_{p2}$$

where:

$$f_{p2} = - (44 - 0.79\sigma_g) \quad \text{when } \sigma_g > 16 \text{ MPa}$$

$$f_{p2} = - (81 - 3.15\sigma_g) \quad \text{when } \sigma_g \leq 16 \text{ MPa}$$

$\sigma_g$  is the stress due to permanent loads,  
all stresses are in MPa,  
and tensile stress is positive.

**NOTE** The limitations in Equation 8.6 provide assurance against fatigue.

8.7 The total shear stress in cast iron shall not exceed 46 MPa.

8.8 The shear stress due to traffic loads  $\tau_{tr}$  shall not exceed the limit in Equation 8.8.

**Equation 8.8 Shear stress limit for traffic loading in cast iron**

$$\tau_{tr} \leq \min \begin{cases} 25 - 0.44\tau_g \\ 44 + 0.79\tau_g \end{cases}$$

where:

$\tau_{tr}$  is the shear stress due to traffic loads only, in MPa, taken as positive

$\tau_g$  is the shear stress due to permanent loads, in MPa,  
taken as positive where it acts in the same direction as  $\tau_{tr}$   
and negative when it acts in the opposite direction as  $\tau_{tr}$

**NOTE** *The limitations in Equation 8.8 provide assurance against fatigue.*

## 9. Normative References

The following documents, in whole or in part, are normative references for this document and are indispensable for its application. For dated references, only the edition cited applies. For undated references, the latest edition of the referenced document (including any amendments) applies.

Ref 1.N	Highways England. BD 63, 'Inspection of highway structures'
Ref 2.N	Highways England. GG 101, 'Introduction to the Design Manual for Roads and Bridges'
Ref 3.N	Highways England. BD 101, 'Structural Review and Assessment of Highway Structures'
Ref 4.N	Highways England. CS 459, 'The assessment of bridge substructures, retaining structures and buried structures'
Ref 5.N	Highways England. BD 61, 'The Assessment of Composite Highway Bridges and Structures'
Ref 6.N	Highways England. BD 44, 'The Assessment of Concrete Highway Bridges and Structures'
Ref 7.N	Highways England. BD 86, 'The Assessment of Highway Bridges and Structures For The Effects of Special Types General Order (STGO) and Special Order (SO) Vehicles'
Ref 8.N	Highways England. BD 56, 'The Assessment of Steel Highway Bridges and Structures'
Ref 9.N	Highways England. BD 79, 'The Management of Sub-standard Highway Structures'

## 10. Informative References

The following documents are informative references for this document and provide supporting information.

Ref 1.l	Proceedings. First ASCE Congress on Computing in Civil Engineering, Washington D.C. Choo B.S., and Gong N.G.. 'An assessment of the Joint Factor as used in the modified MEXE Method' , 20-22nd June 1994, pp. 704-711
Ref 2.l	Proceedings of the ICE. Bridle R.J. and Hughes T.G.. 'An energy method for arch bridge analysis' , Part 2, 1990
Ref 3.l	The Structural Engineer. Harvey W.J.. 'Application of the mechanism analysis to masonry arches' , Vol 66 No.5, March 1988
Ref 4.l	Dept of Civil Engineering, University of Nottingham. Gong, N.G. and Choo, B.S.. 'Assessment of masonry arch bridges - effects of some defects in arch rings' , Report no. SR94014, September 1994, 109pp
Ref 5.l	DCC Document Competence Center Siegm. Kastl e.K.. fib bulletin 80, 'Bulletin 80: Partial factor methods for existing concrete structures'
Ref 6.l	BSI. BS 5628, 'Code of practice for the use of masonry'
Ref 7.l	Highways England. HD 29, 'Data for Pavement Assessment'
Ref 8.l	Proceedings, The Centenary Year Bridge Conference, Cardiff. Gong N.G. and Choo B.S.. 'Effects of diagonal cracks on the behaviour of masonry arch bridges' , 26-30th September 1994, pp. 205-210
Ref 9.l	Transport and Road Research Laboratory. Garwyn Phillips, Philip Blake, David Reeson. TRRL SR 802, 'Estimation of Annual Flow from Short Period Traffic Counts'
Ref 10.l	BSI. BS EN 1991-1-1, 'Eurocode 1 - Actions on Structures - Part 1-1: General actions- Densities, self weight, imposed loads for buildings'
Ref 11.l	BSI. BS EN 1991-2, 'Eurocode 1. Actions on structures. Traffic loads on bridges'
Ref 12.l	BSI. BS EN 1990, 'Eurocode: Basis of structural design'
Ref 13.l	Proceedings of ICE. Choo, B.S., Coutie, M.G. and Gong, N.G.. 'Finite Element Analysis of Masonry Arch Bridges using Tapered Beam Elements' , Part 2, 91, paper no. 9774, December 1991, pp. 755-770
Ref 14.l	ISO. ISO 2394, 'General principles on reliability for structures'
Ref 15.l	CIRIA. CIRIA C764, 'Hidden defects in bridges. Guidance for detection and maintenance'
Ref 16.l	Highways England. CS 463, 'Load testing for bridge assessment'
Ref 17.l	Highways England. BD 37, 'Loads for Highway Bridges' , 2001
Ref 18.l	TRRL Contractor Report 244, 'Masonry properties for assessing arch bridges'
Ref 19.l	Christchurch (MEXE). 'Military load classification (of civil bridges) by the reconnaissance and correlation method' , May 1963
Ref 20.l	'Motor Vehicles (Authorisation of Special Types) Order (Northern Ireland) 1997'
Ref 21.l	'Motor Vehicles (Authorised Weight) Regulations (Northern Ireland) 1999'
Ref 22.l	'Motor Vehicles (Construction and Use) Regulations (Northern Ireland) 1999'

Ref 23.l	ICE Publishing. C.R. Hendy, L.S. Man, R.P. Mitchell and H. Takano. 'Reduced partial factors in UK standards for assessment of bridges and structures, Proceedings of the Institution of Civil Engineers, Bridge Engineering 171, March 2018, Issue BE1, pp3-12'
Ref 24.l	Highways England. TD 19, 'Requirement for Road Restraint Systems'
Ref 25.l	TRRL Laboratory Report 765, 'Temperature differences in bridges: Basis of design requirements'
Ref 26.l	ICE. Pippard A.J.S.. 'The approximate estimation of safe loads on masonry arches' , Civil Engineer in war, 1948
Ref 27.l	Highways England. BD 21, 'The Assessment of Highway Bridges and Structures' , 2001
Ref 28.l	Melbourne, C and Gilbert, M. 'The behaviour of multi-ring brickwork arch bridges, The Structural Engineer Vol 73, No 3, pp39-47, 1995'
Ref 29.l	Proceedings of the ICE. Heyman J.. 'The estimation of the strength of masonry arches' , Part 2, 1980
Ref 30.l	'The Road Vehicles (Authorisation of Special Types) (General) Order 2003'
Ref 31.l	'The Road Vehicles (Authorised Weight) Regulations 1998'
Ref 32.l	'The Road Vehicles (Construction and Use) Regulations 1986'
Ref 33.l	Cambridge University Press. Heyman J.. 'The stone skeleton: structural engineering of masonry architecture' , 1995
Ref 34.l	Journal of the Institution of Civil Engineers. C.S. Chettoe, N. Davey and G.R. Mitchell. 'The Strength of Cast Iron Bridges' , No 8 October 1944

## Appendix A. Partial factors for actions

**Table A.1 Partial factors for actions**

Action	Reference	Limit state	Cast iron structures	Structures excluding cast iron			
				Combination			
				1	2	3	4
Cast iron dead load	Section 5	ULS	1.00	1.10 <sup>[1]</sup>			
		SLS	-	1.00			
Steel dead load	Section 5	ULS	1.00	1.05 <sup>[1]</sup>			
		SLS	-	1.00			
Concrete, stone, masonry or timber dead load	Section 5	ULS	1.00	1.15 <sup>[1]</sup>			
		SLS	-	1.00			
Surfacing superimposed dead load	Section 5	ULS	1.5 <sup>[1]</sup>	1.75 <sup>[1]</sup>			
		SLS	-	1.20			
Other superimposed dead loads	Section 5	ULS	1.0	1.20 <sup>[1]</sup>			
		SLS	-	1.00			
Wind (applied with dead and superimposed dead load only)	Appendix D	ULS	1.00	-	1.40	-	-
		SLS	-	-	1.00	-	-
Wind (applied with dead and superimposed dead load and other combination 2 actions as appropriate)	Appendix D	ULS	1.00	-	1.10	-	-
		SLS	-	-	1.00	-	-
Thermal (restraint to movement)	Appendix D	ULS	1.00	-	-	1.30	-
		SLS	-	-	-	1.00	-
Thermal (temperature difference)	Appendix D	ULS	1.00	-	-	1.00	-
		SLS	-	-	-	0.80	-
Earth pressures (vertical effects)	CS 459 [Ref 4.N]	ULS	1.00	1.20 <sup>[1]</sup>			
		SLS	-	1.00			
Earth pressures (horizontal effects)	CS 459 [Ref 4.N]	ULS	1.00	1.50 <sup>[1]</sup>			
		SLS	-	1.00			
Traffic actions for normal traffic and restricted traffic	Section 5	ULS	1.00	1.50	1.25		
		SLS	-	1.20	1.00		

**Table A.1 Partial factors for actions (continued)**

Action	Reference	Limit state	Cast iron structures	Structures excluding cast iron			
				Combination			
				1	2	3	4
Abnormal traffic actions (SV, SOV, STGO and SO vehicles)	BD 86 [Ref 7.N]	ULS	1.00	1.10	1.00		
		SLS	-	1.00	1.00		
Associated normal traffic when combined with SV, SOV, STGO and SO vehicles	Section 5	ULS	1.00	1.30	1.10		
		SLS	-	1.00	1.00		
Abnormal traffic actions (HB load model and associated normal traffic)	Appendix C	ULS	1.00	1.30	1.10		
		SLS	-	1.10	1.00		
Footway and cycle track loading	Section 5	ULS	1.00	1.50	1.25	1.25	-
		SLS	-	1.00	1.00	1.00	-
Longitudinal load for normal traffic and restricted traffic	Appendix D	ULS	1.00	-	-	-	1.25
		SLS	-	-	-	-	1.00
Longitudinal load for abnormal traffic (SV, SOV, STGO and SO vehicles)	BD 86 [Ref 7.N]	ULS	1.00	-	-	-	1.30
		SLS	-	-	-	-	1.00
Longitudinal load for abnormal traffic (HB load model)	Appendix C	ULS	1.00	-	-	-	1.10
		SLS	-	-	-	-	1.00
Note 1. The partial factors for all parts of the dead and superimposed loads are taken as 1.0 where this gives a more severe total effect.							

65

CS 454 Revision 0

Appendix A. Partial factors for actions

## Appendix B. Vehicle load models

### B1 Vehicle load models for normal and restricted loading levels

Table B.1 contains axle weights and spacings for the critical vehicles in each of the assessment live loading levels. Table B.2 contains the axle weights and spacings for fire engines in group 1 and group 2. Where an assessment of the load effects for specific fire engines is required, the axle weights and spacings should be obtained from the manufacturer.

Each axle load should consist of two equal wheel loads, with a transverse spacing of 1.8m between their centres.

Each wheel load should be uniformly distributed over a 0.3 x 0.3m square contact area.

**Table B.1 Vehicle load models**

Assessment live loading level	Vehicle details			Axle weights and spacings <sup>[2]</sup>												
	Ref <sup>[1]</sup>	Gross vehicle weight (tonnes)	No. of axles	O <sub>1</sub> (m)	W <sub>1</sub> (kN)	A <sub>1</sub> (m)	W <sub>2</sub> (kN)	A <sub>2</sub> (m)	W <sub>3</sub> (kN)	A <sub>3</sub> (m)	W <sub>4</sub> (kN)	A <sub>4</sub> (m)	W <sub>5</sub> (kN)	A <sub>5</sub> (m)	W <sub>6</sub> (kN)	O <sub>2</sub> (m)
Normal traffic	A	32	4	1.00	64	1.20	64	3.90	113	1.30	74					1.00
	B	38	4	1.00	64	3.00	113	5.10	98	1.80	98					1.00
	C	40	5	1.00	59	3.00	113	4.20	74	1.35	74	1.35	74			1.00
	D	40	5	1.00	59	2.80	113	1.30	64	5.28	78	1.02	78			1.00
	D	40	5	1.00	59	2.80	64	1.30	113	5.28	78	1.02	78			1.00
	E	40	5	1.00	49	2.80	103	1.30	44	4.80	98	1.80	98			1.00
	E	40	5	1.00	49	2.80	44	1.30	103	4.80	98	1.80	98			1.00
	F	41	6	1.00	49	2.80	103	1.30	49	4.18	67	1.35	67	1.35	67	1.00
	F	41	6	1.00	49	2.80	49	1.30	103	4.18	67	1.35	67	1.35	67	1.00
	G	44	6	1.00	59	2.80	103	1.30	49	4.70	74	1.35	74	1.35	74	1.00
	G	44	6	1.00	59	2.80	49	1.30	103	4.70	74	1.35	74	1.35	74	1.00
	H	44	5	1.00	69	2.80	113	1.30	74	7.60	88	1.35	88			1.00
H	44	5	1.00	69	2.80	74	1.30	113	7.60	88	1.35	88			1.00	
26 tonnes	I	26	3	1.00	42	2.67	78	1.02	78							1.00
	J	26	3	1.00	69	3.42	93	1.30	93							1.00
	K	26	3	1.00	69	3.42	113	1.30	74							1.00
	K	26	3	1.00	69	3.42	74	1.30	113							1.00
	L	26	3	1.00	64	3.00	113	5.30	78							1.00
	L	26	3	1.00	64	3.00	78	5.30	113							1.00
18 tonnes	M	18	2	1.00	64	3.00	113									1.00

**Table B.1 Vehicle load models** (continued)

7.5 tonnes	N	7.5	2	1.00	59	2.00	15									1.00
3 tonnes	O	3	2	0.75	21	2.00	9									1.00

Note 1: Vehicle references are described in Table B.3.

Note 2: Notations for axle weights and spacings are defined in Figure B.1.

**Table B.2 Vehicle load models for fire engines groups 1 and 2**

Fire engine group <sup>[1,2]</sup>	$W_1$ (kN)	$A_1$ (m)	$W_2$ (kN)
Group 1	65	3.5-5.8 <sup>[3]</sup>	100
Group 2	32	3.5	50

Note 1: Group 1 includes 2-axle fire engines up to a gross vehicle weight of up to 17 tonnes, a maximum axle load of up to 100kN, and an axle spacing of between 3.5m and 5.8m.  
 Note 2: Group 2 includes 2-axle fire engines up to a gross vehicle weight of up to 8.5 tonnes, and a maximum axle load of up to 50kN, and a minimum axle spacing of 3.5m.  
 Note 3: The axle spacing should be selected from the range of values to give the most onerous effect.

**Figure B.1 Notation for axle weights and spacings defined in vehicle models**

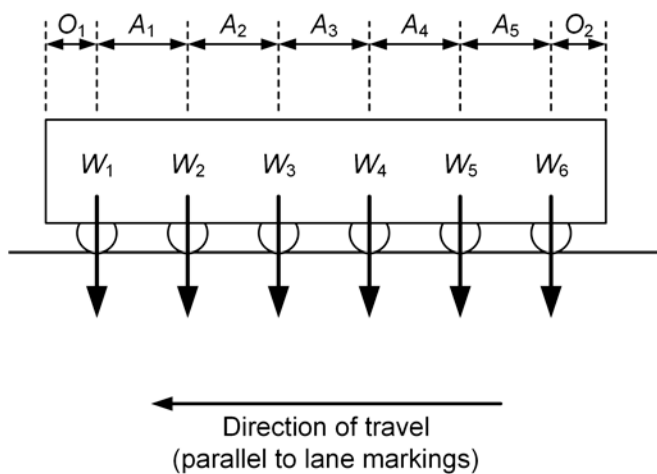

**Table B.3 Vehicle descriptions**

Vehicle reference	Description
A	4-axle rigid
B	2+2 articulated
C	2+3 articulated
D	3+2 articulated
E	3+2 articulated with 10.5 tonne drive axle
F	3+3 articulated, maximum axle weight 10.5 tonnes
G	3+3 articulated, maximum axle weight 10.5 tonnes
H	3+2 articulated, 40ft ISO container, international intermodal journeys only
I	short wheelbase, minimum bogey axle spacing vehicle
J	maximum equal bogey axle weight vehicle
K	maximum axle weight
L	3 axle articulated, king-pin assumed 0.2m in front of centreline of rear axle
M	18 tonne vehicle
N	7.5 tonne vehicle
O	3 tonne vehicle

## Appendix C. HB Vehicle load models

### C1 Introduction

The HB Vehicle load model can be used to model the load effects of vehicles carrying exceptional industrial loads, such as electrical transformers, generators, pressure vessels and machine presses.

The HB Vehicle load model consists of a vehicle model, with axle loads dependent on the number of units of HB loading under consideration.

When HB loading was used for design, the number of units was typically between 30 and 45, as in BD 37 2001 [Ref 17.1]. For assessment, the number of units that the structure can take can be determined by calculation.

### C2 HB Vehicle model

One unit of the HB vehicle model consists of a four axle vehicle with each axle consisting of four 2.5kN wheel loads, arranged as shown in Figure C.1.

The inner axle spacing of the HB Vehicle load model should be selected from the values given in Figure C.1 to cause the most severe effect on the member or element under consideration.

**Figure C.1 Dimensions of HB Vehicle model**

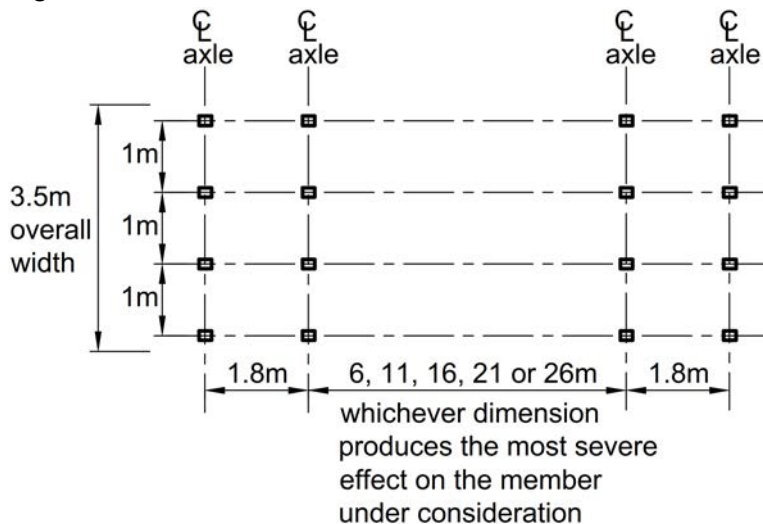

The wheel loads should be uniformly distributed over a circular or square contact area, with an effective pressure of 1.1N/mm<sup>2</sup>.

The wheel loads should be dispersed at a spread to depth ratio of 1 horizontally to 2 vertically through asphalt and similar surfacing, or a spread to depth ratio of 1 horizontally to 1 vertically through structural concrete slabs.

The longitudinal actions arising from traction or braking of vehicles should be taken as 25% of the total applied HB load, applied equally distributed between the eight wheels of two axles of the vehicle.

### C3 Application of HB Vehicle load

A single HB Vehicle should be applied to the bridge, at any transverse position, selected to cause the most severe effect on the member or element under consideration.

Loading from normal traffic should be applied to the carriageway in all areas where vehicles would not be displaced by the HB Vehicle.

Where ALL model 1 is used, the normal traffic loading for each lane should be applied in accordance with Table C.1.

**Table C.1 Normal traffic loading to accompany HB Vehicle using ALL model 1**

Lane	Normal traffic loading within lane
HB Vehicle in lane with remaining width of lane (measured from the side of the HB vehicle to the edge of the lane) less than 2.5m.	No other traffic loading within 25m of the front or rear axles of the HB vehicle. ALL model 1 applied to remainder of lane.
Otherwise	ALL model 1 applied to lane.

The lane factors used for ALL model 1 are interchangeable between lanes and should be selected to cause the most severe effect on the member or element under consideration.

Where ALL model 2 is used, the normal traffic loading for each notional lane should be applied in accordance with Table C.2.

**Table C.2 Normal traffic loading to accompany HB Vehicle, using ALL model 2,**

Notional Lane	Normal traffic loading within notional lane
HB Vehicle in notional lane with remaining width of notional lane (measured from the side of the HB vehicle to the edge of the notional lane) less than 2.5m.	No other traffic loading within 25m of the front or rear axles of the HB Vehicle. ALL model 2 UDL applied to remainder of notional lane, calculated using the whole loaded length, including the length occupied by the HB vehicle and the two 25m areas.
HB Vehicle in notional lane with remaining width of notional lane (measured from the side of the HB Vehicle to the edge of the notional lane) greater than or equal to 2.5m.	ALL model 2 UDL applied to lane.
Notional lane with no HB Vehicle.	ALL model 2 (UDL and KEL) applied to lane.

The notional lane factors used for ALL model 2 are interchangeable between notional lanes and should be selected to cause the most severe effect on the member or element under consideration.

Figure C.2 illustrates typical configurations of HB vehicle loading in combination with ALL model 2 (lane factors are denoted  $\beta_1, \beta_2, \dots, \beta_n$ ).

**Figure C.2 Typical configurations of HB Vehicle loading, applied in combination with ALL model 2**

(1) HB vehicle within one notional lane

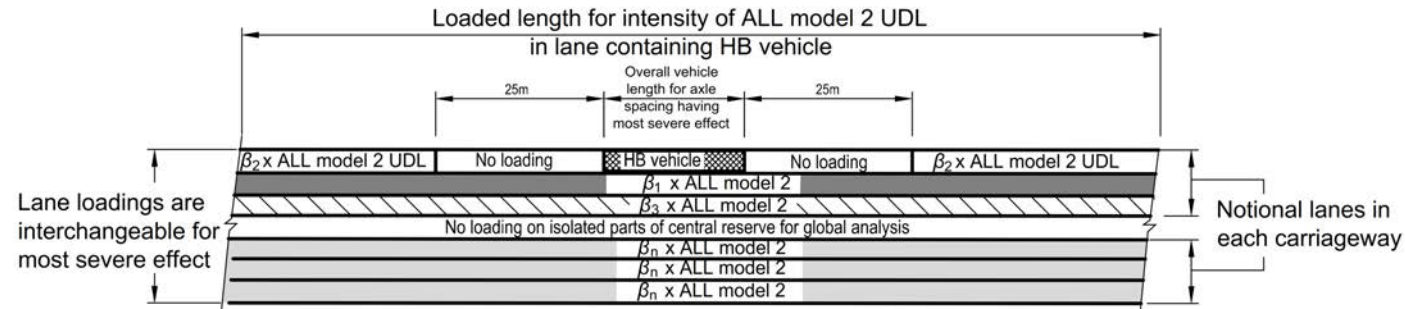

(2) HB vehicle straddling two notional lanes

(a)

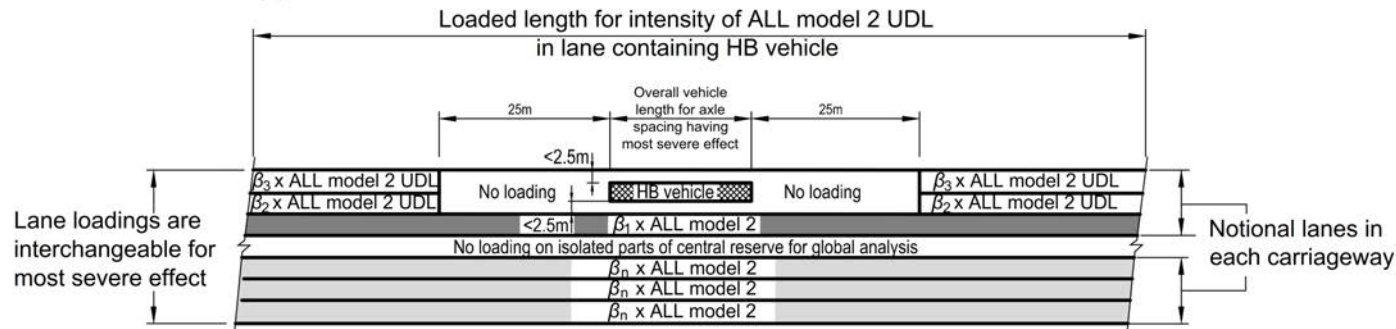

(b)

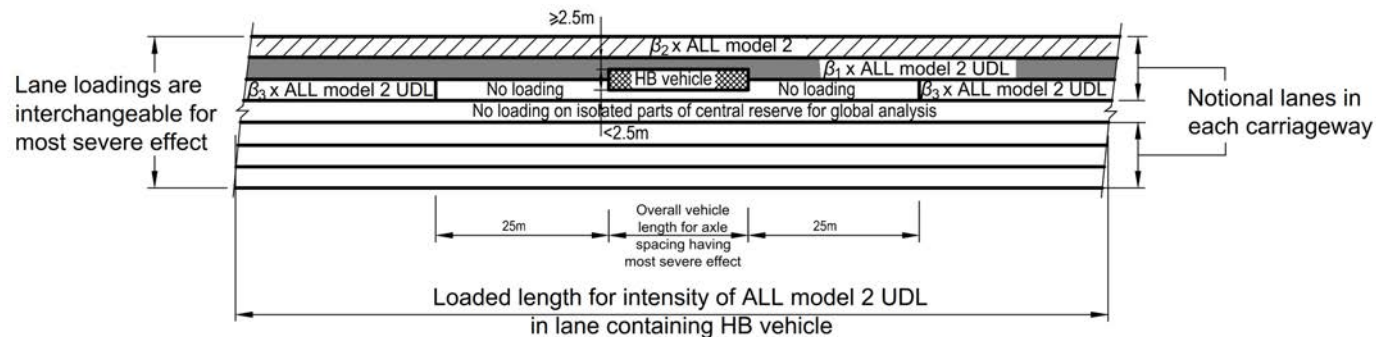

## Appendix D. Models for wind and thermal actions

### D1 Wind loading

#### D1.1 General

In this wind loading model, the wind action is represented by a simplified set of static forces whose effects are equivalent to the extreme effects of turbulent wind.

The wind force on a bridge depends on:

- 1) the wind speed;
- 2) the geographical location;
- 3) the terrain of the surrounding area;
- 4) the fetch of terrains upwind of the site location;
- 5) the local topography;
- 6) the height of the bridge above ground;
- 7) the horizontal dimensions and cross-section of the bridge or element under consideration.

Vertical elements such as piers and towers should be divided into sections in accordance with the heights given in Table D.1, with a separate wind force derived for each section.

Where the bridge is located over tidal waters, the height above ground should be measured from the mean water level.

**Table D.1 Heights above ground for division of vertical elements**

Height above ground (m)
5
10
15
20
30
40
50
60
80
100
150
200

#### D1.2 Wind speed

The wind speed for assessment,  $V_w$ , should be determined.

Where wind on any part of the bridge increases the effect under consideration, the wind speed for assessment,  $V_w$ , should be taken as the maximum wind gust speed,  $V_d$ .

Where wind on any part of the bridge decreases the effect under consideration, the wind speed for assessment,  $V_w$ , should be taken as the hourly mean wind speed,  $V_r$ .

##### D1.2.1 Maximum wind gust speed

The maximum wind gust speed,  $V_d$ , should be determined in accordance with Equation D.1.

**Equation D.1 Maximum wind gust speed**

$$V_d = V_s \cdot S_g$$

where:

$V_s$	the site hourly mean wind speed
$S_g$	the gust factor

Where wind loading is being applied in combination with vehicular or pedestrian loading on a highway, pedestrian, or cycle bridge, the maximum wind gust speed,  $V_d$ , should not exceed 35m/s.

The site hourly mean wind speed,  $V_s$ , should be determined in accordance with Equation D.2.

**Equation D.2 Site hourly mean wind speed**

$$V_s = V_b \cdot S_p \cdot S_a \cdot S_d$$

where:

$V_b$	the basic hourly mean wind speed
$S_p$	the probability factor
$S_a$	the altitude factor
$S_d$	the direction factor

The basic hourly mean wind speed,  $V_b$ , for the location of the bridge should be obtained from the map of isotachs given in Figure D.1.

Figure D.1 Basic hourly mean wind speed (m/s)

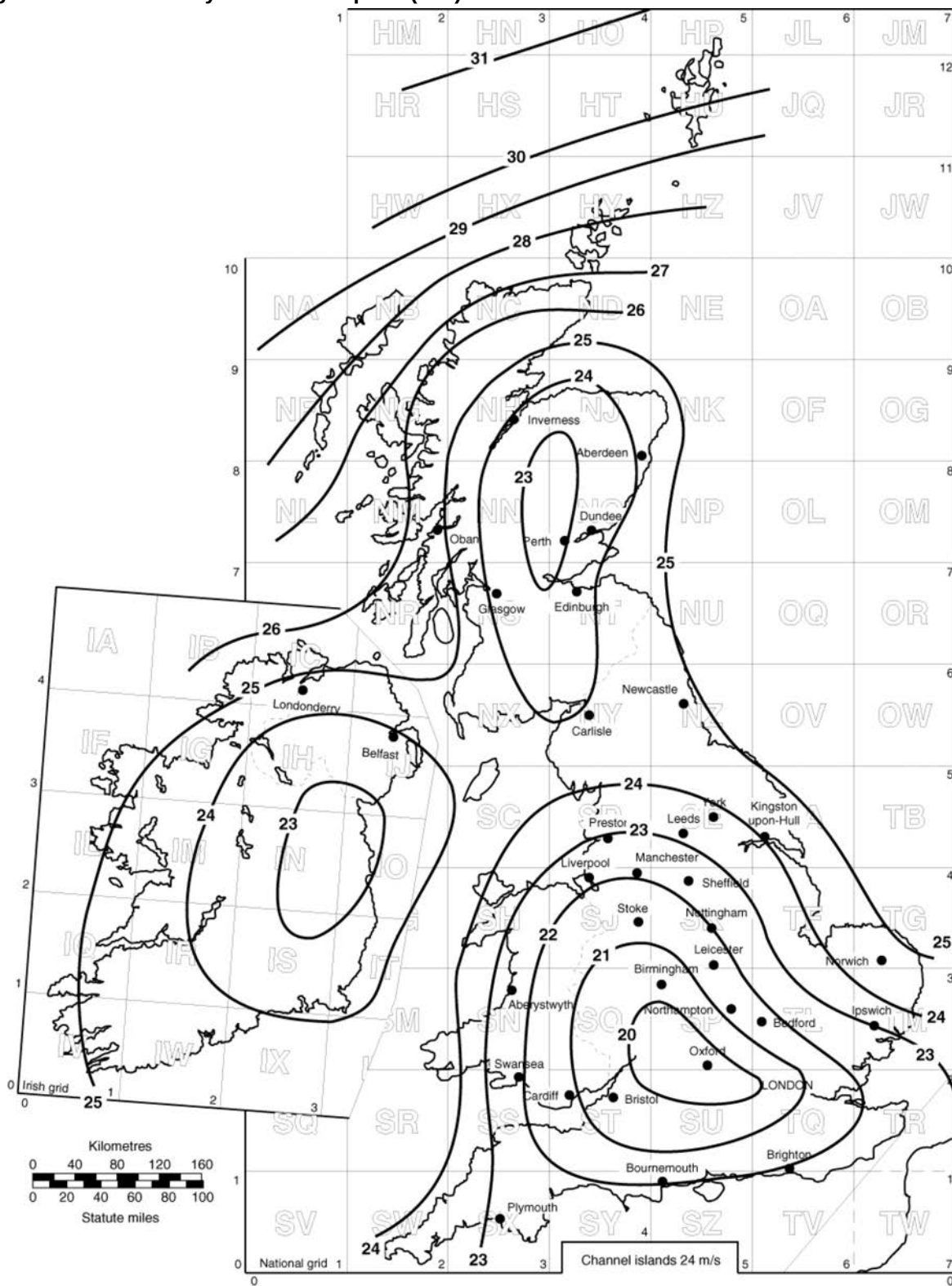

**Copyright BRE**

The basic hourly mean wind speed values given in Figure D.1 are hourly mean wind speeds with an annual probability of exceedance of 0.02 in flat open country at an altitude of 10m above sea level.

The probability factor,  $S_p$ , should be determined in accordance with Equation D.3.

**Equation D.3 Probability factor**

$$S_p = \sqrt{\frac{5 - \ln(-\ln(1 - Q))}{5 - \ln(-\ln(0.98))}}$$

where:

- $Q$  the required annual risk of exceedance  
 $Q = 0.02$  for a 50 year return period, giving  $S_p = 1.00$   
 $Q = 0.0083$  for a 120 year return period, giving  $S_p = 1.05$

The altitude factor,  $S_a$ , should be determined in accordance with Equation D.4.

**Equation D.4 Altitude factor**

$$S_a = 1 + 0.001\Delta$$

where:

- $\Delta$  the altitude (in metres) above mean sea level of:
  - 1) the ground level of the site, when the structure is not affected by any topographic features with an upwind slope greater than 0.05;
  - 2) the base of the topographic feature, when the structure is affected by significant topography (determined in accordance with Figure D.2 and Table D.2).



**Table D.2 Topographic dimensions**

Dimension	Definition
$L_U$	the length of the upwind slope in the wind direction
$L_D$	the length of the downwind slope in the wind direction
$Z$	the effective height of the topographic feature
$\Psi_U$	the upwind slope in the wind direction, $\Psi_U = \frac{Z}{L_U}$
$\Psi_D$	the downwind slope in the wind direction, $\Psi_D = \frac{Z}{L_D}$
$X$	the horizontal distance of the bridge site from the crest
$\Delta_T$	the altitude of the upwind base of the topographic feature. In undulating terrain this should be taken as the average level of the terrain upwind of the site for a distance of 5km.
$\Delta_S$	the altitude of the site

The direction factor,  $S_d$ , should be taken from Table D.3 (values may be interpolated).

**Table D.3 Direction factor**

Wind direction	Wind angle (degrees)	Direction factor, $S_d$
North	0	0.78
	30	0.73
	60	0.73
East	90	0.74
	120	0.73
	150	0.80
South	180	0.85
	210	0.93
	240	1.00
West	270	0.99
	300	0.91
	330	0.82

Where the orientation of the bridge is unknown, the direction factor,  $S_d$ , should be taken as 1.00 for all wind directions.

The gust factor,  $S_g$ , should be determined in accordance with Equation D.5.

**Equation D.5 Gust factor**

$$S_g = S'_b \cdot K_F \cdot T_g \cdot S'_h$$

where:

$S'_b$	the bridge and terrain factor
$K_F$	the fetch correction factor
$T_g$	the town gust reduction factor
$S'_h$	the topography factor

The bridge and terrain factor,  $S'_b$ , should be taken from Table D.4.

**Table D.4 Bridge and terrain factor**

Height above ground (m)	Bridge and terrain factor, $S'_b$					
	Loaded length for wind loading (m)					
	20	40	60	100	200	400
5	1.56	1.51	1.48	1.44	1.39	1.34
10	1.68	1.64	1.61	1.57	1.52	1.47
15	1.76	1.71	1.68	1.64	1.60	1.55
20	1.81	1.76	1.73	1.69	1.65	1.60
30	1.88	1.83	1.80	1.76	1.71	1.66
40	1.92	1.87	1.85	1.81	1.76	1.71
50	1.96	1.91	1.88	1.84	1.80	1.75
60	1.98	1.94	1.91	1.87	1.83	1.78
80	2.02	1.98	1.95	1.92	1.87	1.82
100	2.05	2.01	1.98	1.95	1.90	1.86
150	2.11	2.06	2.04	2.01	1.97	1.92
200	2.15	2.11	2.08	2.05	2.01	1.97

The fetch correction factor,  $K_F$ , should be taken from Table D.5.

**Table D.5 Fetch correction factor**

Height above ground (m)	Fetch correction factor, $K_F$					
	Upwind distance of site from sea (km)					
	$\leq 0.3$	<b>1</b>	<b>3</b>	<b>10</b>	<b>30</b>	$\geq 100$
5	1.00	0.96	0.94	0.91	0.90	0.85
10	1.00	0.99	0.96	0.94	0.92	0.88
15	1.00	0.99	0.98	0.96	0.94	0.89
20	1.00	1.00	0.99	0.97	0.95	0.90
30	1.00	1.00	0.99	0.98	0.96	0.92
40	1.00	1.00	1.00	0.99	0.98	0.93
50	1.00	1.00	1.00	0.99	0.98	0.93
60	1.00	1.00	1.00	0.99	0.99	0.94
80	1.00	1.00	1.00	1.00	0.99	0.95
100	1.00	1.00	1.00	1.00	0.99	0.95
150	1.00	1.00	1.00	1.00	1.00	0.96
200	1.00	1.00	1.00	1.00	1.00	0.97

Where the bridge site is situated within a built up area with a general level of roof tops of at least 5m above ground level, or within permanent forest or woodland, the town gust reduction factor,  $T_g$ , should be taken from Table D.6.

**Table D.6 Town gust reduction factor**

Height above ground (m)	Town gust reduction factor, $T_g$			
	Distance from edge of town, or woodland, in upwind direction (km)			
	<b>&lt; 3</b>	<b>3</b>	<b>10</b>	<b>30</b>
5	1.00	0.84	0.81	0.79
10	1.00	0.91	0.87	0.85
15	1.00	0.94	0.90	0.88
20	1.00	0.96	0.92	0.90
30	1.00	0.98	0.95	0.92
40	1.00	0.99	0.97	0.94
50	1.00	0.99	0.98	0.95
60	1.00	0.99	0.99	0.96
80	1.00	0.99	0.99	0.98
100	1.00	1.00	1.00	1.00
150	1.00	1.00	1.00	1.00
200	1.00	1.00	1.00	1.00

Where the bridge site is not situated within a built up area, or permanent forest or woodland, the town gust reduction factor,  $T_g$ , should be taken as 1.00.

The topography factor,  $S'_h$ , should be determined in accordance with Table D.7.

**Table D.7 Topography factor**

Situation	Topography factor, $S'_h$
Bridge located in a valley where local funnelling of the wind occurs	At least 1.1. Specialist advice should be sought.
Bridge located to the lee of a range of hills causing local acceleration of the wind	At least 1.1. Specialist advice should be sought.
Bridge affected by a significant topographic feature (as defined in Figure D.2)	Calculate in accordance with guidance provided in D1.6.
Bridge located in a steep-sided enclosed valley where wind speeds are expected to be less than in level terrain	Specialist advice should be sought.
Otherwise	1.0

**D1.2.2 Hourly mean wind speed**

The hourly mean wind speed,  $V_r$ , should be determined in accordance with Equation D.6.

**Equation D.6 Hourly mean wind speed**

$$V_r = V_s \cdot S_m$$

where:

- $V_s$  the site hourly mean wind speed
- $S_m$  the hourly mean speed factor

Where wind loading is being applied in combination with vehicular or pedestrian loading on a highway, pedestrian, or cycle bridge, the hourly mean wind speed,  $V_r$ , should not exceed  $35 \cdot \frac{S'_c}{S'_b}$  m/s, where  $S'_c$  is the hourly speed factor and  $S'_b$  is the bridge and terrain factor.

The site hourly mean wind speed,  $V_s$ , should be determined in accordance with Equation D.2.

The hourly mean speed factor,  $S_m$ , should be determined in accordance with Equation D.7.

**Equation D.7 Hourly mean speed factor**

$$S_m = S'_c \cdot K_F \cdot T_c \cdot S'_h$$

where:

- $S'_c$  the hourly speed factor
- $K_F$  the fetch correction factor
- $T_c$  the hourly mean town reduction factor
- $S'_h$  the topography factor

The hourly speed factor,  $S'_c$ , should be taken from Table D.8.

**Table D.8 Hourly speed factor**

Height above ground (m)	Hourly speed factor, $S'_c$
5	1.02
10	1.17
15	1.25
20	1.31
30	1.39
40	1.43
50	1.47
60	1.50
80	1.55
100	1.59
150	1.67
200	1.73

The fetch correction factor,  $K_F$ , should be taken from Table D.5.

Where the bridge site is situated within a built up area with a general level of roof tops of at least 5m above ground level, or within permanent forest or woodland, the hourly mean town reduction factor,  $T_c$ , should be taken from Table D.9.

**Table D.9 Hourly mean town reduction factor**

Height above ground (m)	Hourly mean town reduction factor, $T_c$			
	Distance from edge of town, or woodland, in upwind direction (km)			
	< 3	3	10	30
5	1.00	0.74	0.71	0.69
10	1.00	0.81	0.78	0.76
15	1.00	0.84	0.82	0.80
20	1.00	0.87	0.84	0.82
30	1.00	0.89	0.86	0.84
40	1.00	0.91	0.88	0.86
50	1.00	0.93	0.90	0.87
60	1.00	0.94	0.91	0.88
80	1.00	0.95	0.92	0.90
100	1.00	0.96	0.93	0.91
150	1.00	0.98	0.95	0.93
200	1.00	1.00	0.96	0.94

Where the bridge site is not situated within a built up area, or permanent forest or woodland, the hourly mean town reduction factor,  $T_c$ , should be taken as 1.00.

The topography factor,  $S'_h$ , should be determined in accordance with Table D.7.

### D1.3 Transverse wind load

#### D1.3.1 General

The nominal transverse wind load acting on an element,  $P_T$ , should be derived in accordance with

Equation D.8.

**Equation D.8 Nominal transverse wind load**

$$P_T = 0.613 \cdot V_w^2 \cdot A_1 \cdot C_D$$

where:

- $V_w$  the wind speed for assessment (m/s)
- $A_1$  the solid area of the structure or element in normal projected elevation ( m<sup>2</sup> )
- $C_D$  the drag coefficient

The nominal transverse wind load,  $P_T$  , should be taken as acting horizontally at the centroid of the area of the element, unless local conditions change the direction of the wind.

**D1.3.2 Highway and rail bridge superstructures with solid elevation**

The nominal transverse wind load,  $P_T$  , should be derived separately for the area of each of the elements given in Table D.10.

**Table D.10 Nominal transverse wind load for highway and rail bridge superstructures with solid elevation**

Live load present	Parapet type	Elements for which nominal transverse wind load should be derived
No	Open	1) the superstructure, using depth $d = d_1$ from Figure D.3; 2) the solid areas of no more than two parapets or safety fences, selected to produce the most onerous effect.
	Solid	1) the superstructure, using depth $d = d_2$ from Figure D.3; 2) the solid areas of any additional parapets or safety fences above the top of the solid windward parapet.
Yes	Open	1) the superstructure and live load, using depth $d = d_3$ from Figure D.3, where $d_L$ should be taken as 2.5m for highway bridges, 3.7m for rail bridges, or 1.25m for foot or cycle bridges; 2) the solid areas of any additional parapets or safety fences above the top of the live load.
	Solid	1) the superstructure and live load, using the greater of depth $d = d_2$ or $d = d_3$ from Figure D.3, where $d_L$ should be taken as 2.5m for highway bridges, 3.7m for rail bridges, or 1.25m for foot or cycle bridges; 2) the solid areas of any additional parapets or safety fences above the top of the live load.

**Figure D.3 Depth to be used when deriving solid area of superstructure**

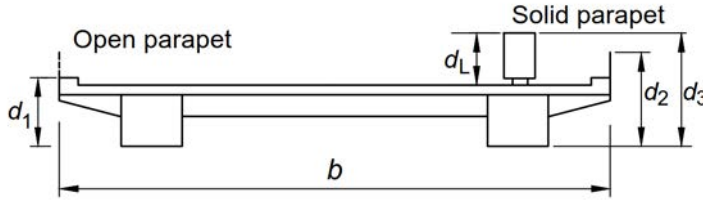

**D1.3.3 Foot / cycle bridge superstructures with solid elevation**

Where the ratio  $\frac{b}{d}$ , derived in accordance with Figure D.3 and Table D.10, is greater than or equal to 1.1, the nominal transverse wind load,  $P_T$ , should be derived as for a highway bridge superstructure.

Where the ratio  $\frac{b}{d}$ , derived in accordance with Figure D.3 and Table D10, is less than 1.1, the nominal transverse wind load,  $P_T$ , should be derived as for a highway bridge superstructure except that the solid area of the leeward parapet should be ignored.

**D1.3.4 Truss girder bridge superstructures**

The nominal transverse wind load,  $P_T$ , should be derived separately for the solid areas of each of the following elements:

- 1) the windward and leeward truss girders;
- 2) the deck;
- 3) the windward and leeward parapets or safety fences;
- 4) the depth of any live load.

The nominal transverse wind load,  $P_T$ , should be neglected on projected areas under the following circumstances:

- 1) parts of the windward parapet which are screened by the windward truss;
- 2) parts of the windward truss which are screened by the windward parapet or the deck;
- 3) parts of the deck which are screened by the windward truss;
- 4) parts of any live load which are screened by the windward truss or the windward parapet;
- 5) parts of the leeward truss which are screened by any live load or the deck or the leeward parapet;
- 6) parts of the leeward parapet which are screened by any live load or the leeward truss.

**D1.3.5 Piers**

The nominal transverse wind load,  $P_T$ , should be determined for the solid area of each pier with no allowance for any shielding.

Piers should be divided into sections in accordance with the heights given in Table D.1, with a separate transverse wind load determined for each section.

**D1.3.6 Drag coefficient for all superstructures with solid elevation**

Where any of the following conditions occur, the drag coefficient,  $C_D$ , should be determined from wind tunnel tests:

- 1) the superstructure has any of the forms shown in Figure D.4;
- 2) the superstructure is subject to inclined wind at an angle exceeding 5°;
- 3) the superstructure is superelevated and also subject to inclined wind.

**Figure D.4 Typical superstructures that require wind tunnel tests to determine drag coefficient**

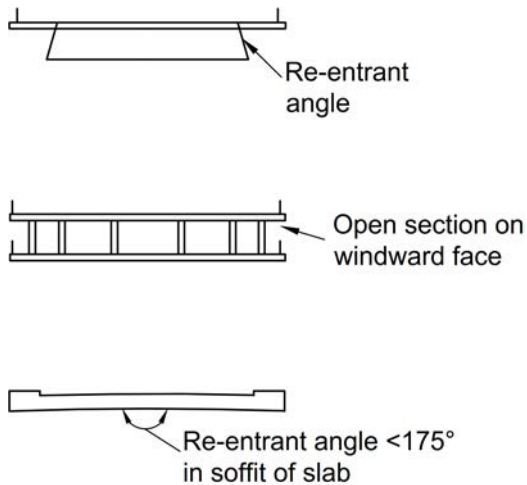

Where the superstructure has any of the forms shown in Figure D.5, the drag coefficient,  $C_D$ , should be determined in accordance with Figure D.6, using the breadth to depth ratio,  $\frac{b}{d}$ , determined in accordance with Table D.11.

**Figure D.5 Typical superstructures to which Figure D.6 applies**

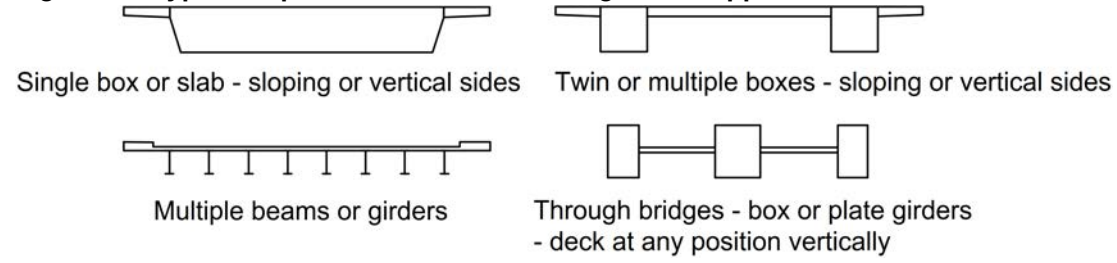
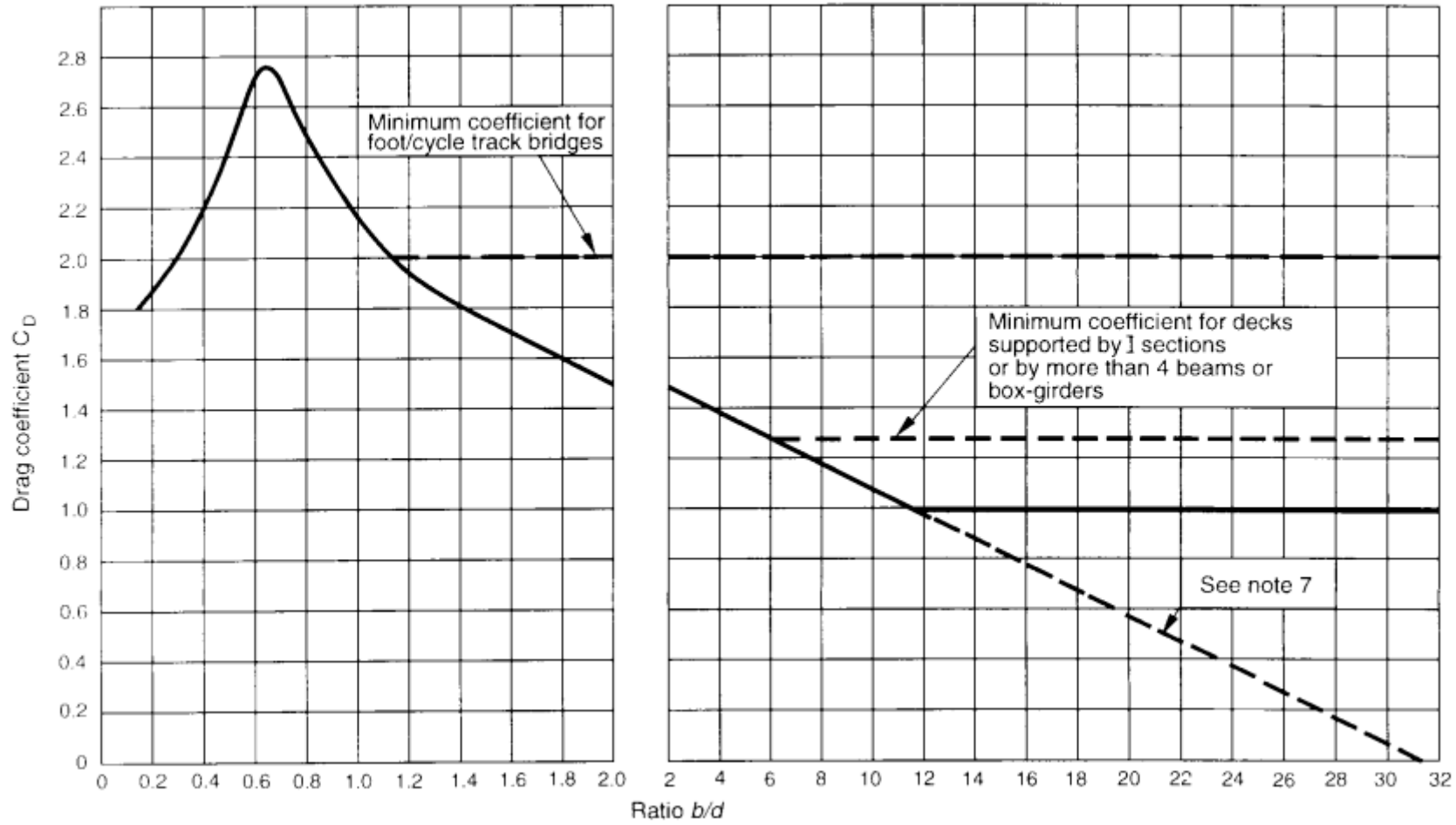

Figure D.6 Drag coefficient for superstructures with solid elevation



**Table D.11 Depth to be used when deriving drag coefficient**

Superstructure form	Parapet	Superstructures without live load	Superstructures with live load
<p>Superstructures where the depth of the superstructure (<math>d_1</math> or <math>d_2</math>) exceeds <math>d_L</math></p>	Open	$d = d_1$	$d = d_1$
	Solid	$d = d_2$	$d = d_2$
<p>Superstructures where the depth of the superstructure (<math>d_1</math> or <math>d_2</math>) is less than <math>d_L</math></p>	Open	$d = d_1$	$d = d_L$
	Solid	$d = d_2$	$d = d_L$

Where the windward face of the superstructure is inclined to the vertical, the drag coefficient,  $C_D$ , may be reduced by 0.5% per degree of inclination from the vertical, subject to a maximum reduction of 30%.

Where the windward face of the superstructure consists of two parts inclined at different angles, the drag coefficient,  $C_D$ , should be determined separately for each area, in each case taking the depth,  $d$ , as the total vertical depth over all parts.

Where the superstructure is superelevated, the drag coefficient,  $C_D$ , may be increased by 3% per degree of inclination from the horizontal, subject to a maximum increase of 25%.

Where the superstructure is subject to inclined wind, the drag coefficient,  $C_D$ , should be increased by 15%.

Where two similar superstructures are separated transversely by a gap not exceeding 1m, the drag coefficient,  $C_D$ , for each superstructure should be determined in accordance with Table D.12.

**Table D.12 Drag coefficients for similar superstructures separated transversely by a gap not exceeding 1m**

Superstructure	Drag coefficient, $C_D$
Windward	Calculated for the windward superstructure alone. Where $\frac{b}{d} > 12$ , the dashed line in Figure D.6 should be used to determine $C_D$ .
Leeward	Calculated as the difference between the drag coefficient obtained by taking the breadth, $b$ , as the combined width of both superstructures, and the drag coefficient obtained for the windward superstructure alone. Where $\frac{b}{d} > 12$ , the dashed line in Figure D.6 should be used to determine $C_D$ .

**D1.3.7 Drag coefficient for all truss girder superstructures**

The drag coefficient,  $C_D$ , for the windward truss should be taken from Table D.13.

**Table D.13 Drag coefficient for windward truss**

Ratio of net area to overall area of truss	Drag coefficient, $C_D$		
	Flatsided members	Round members, of diameter $d_t$	
		$d_t \cdot V_w < 6 \text{ m}^2/\text{s}$	$d_t \cdot V_w \geq 6 \frac{\text{m}^2}{\text{s}}$
0.1	1.9	1.2	0.7
0.2	1.8	1.2	0.8
0.3	1.7	1.2	0.8
0.4	1.7	1.1	0.8
0.5	1.6	1.1	0.8

The drag coefficient,  $C_D$ , for any trusses located downwind of the windward truss should be determined by multiplying the drag coefficient for the windward truss by a shielding factor,  $\eta$ , taken from Table D.14.

**Table D.14 Shielding factor for trusses located downwind of the windward truss**

Spacing ratio	Shielding factor, $\eta$				
	Ratio of net area to overall area of truss				
	0.1	0.2	0.3	0.4	0.5
Less than 1	1.00	0.90	0.80	0.60	0.45
2	1.00	0.90	0.80	0.65	0.50
3	1.00	0.95	0.80	0.70	0.55
4	1.00	0.95	0.85	0.70	0.60
5	1.00	0.95	0.85	0.75	0.65
6	1.00	0.95	0.90	0.80	0.70

The spacing ratio should be determined by dividing the distance between the centres of the windward truss and the truss adjacent to the windward truss by the depth of the windward truss.



The drag coefficient,  $C_D$ , for the deck construction should be taken as 1.1.

The drag coefficient,  $C_D$ , for any unshielded parts of the live load should be taken as 1.45.

**D1.3.8 Drag coefficient for parapets and safety fences**

The drag coefficient,  $C_D$ , for parapets or safety fences should be determined in accordance with Table D.15.

**Table D.15 Drag coefficients for parapets and safety fences**

Parapet cross section	Drag coefficient, $C_D$
<p><b>Circular sections</b></p> 	$dV_d < 6 \text{ m}^2/2$ 1.2
	$dV_d > 6 \text{ m}^2/s$ 0.7
<p><b>Flat members with rectangular corner, crash barrier rails and solid parapets</b></p> 	2.2
<p><b>Square members diagonal to wind</b></p> 	1.5

**Table D.15 Drag coefficients for parapets and safety fences (continued)**

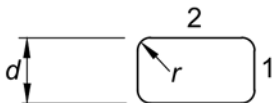
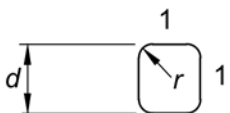
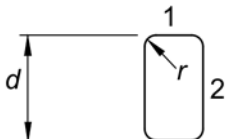
<p><b>Circular stranded cables</b></p> 		1.2
<p><b>Rectangular members with circular corners</b></p> 	$r > \frac{d}{12}$	1.1
<p><b>Square members with circular corners</b></p> 	$r > \frac{d}{12}$	1.5
<p><b>Rectangular members with circular corners</b></p> 	$r > \frac{d}{24}$	2.1
<p>Note: For sections with intermediate proportions, <math>C_D</math> may be obtained by interpolation</p>		

**D1.3.9 Drag coefficient for piers**

The drag coefficient,  $C_D$ , for piers should be determined in accordance with Table D.16.

Where the pier has a cross section which is not included in Table D.16, the drag coefficient,  $C_D$ , should be determined from wind tunnel tests.

**Table D.16 Drag coefficient for piers**

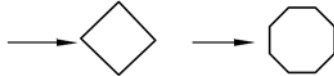
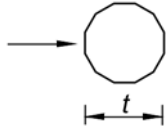
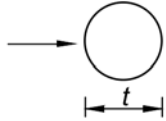
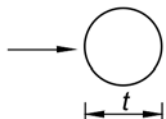
Plan shape		$C_D$ for pier $\frac{\text{height}}{\text{breadth}}$ ratios of						
		1	2	4	6	10	20	40
<b>Rectangle</b> 	$\frac{t}{b} \leq 0.25$	1.3	1.4	1.5	1.6	1.7	1.9	2.1
	$0.33 \leq \frac{t}{b} \leq 0.67$	1.3	1.4	1.5	1.6	1.8	2.0	2.2
	$\frac{t}{b} = 1$	1.2	1.3	1.4	1.5	1.6	1.8	2.0
	$\frac{t}{b} = 1.5$	1.0	1.1	1.2	1.3	1.4	1.5	1.7
	$\frac{t}{b} = 2$	0.8	0.9	1.0	1.1	1.2	1.3	1.4
	$\frac{t}{b} = 3$	0.8	0.8	0.8	0.9	0.9	1.0	1.2
	$\frac{t}{b} \geq 4$	0.8	0.8	0.8	0.8	0.8	0.9	1.1
<b>Square or octagonal</b> 		1.0	1.1	1.1	1.2	1.2	1.3	1.4
<b>12-sided polygon</b> 		0.7	0.8	0.9	0.9	1.0	1.1	1.3
<b>Circle with smooth surface</b> 	$\frac{tV_d}{s} \geq 6 \text{ m}^2$	0.5	0.5	0.5	0.5	0.5	0.6	0.6
	$\frac{tV_d}{s} < 6 \text{ m}^2$	0.7	0.7	0.8	0.8	0.9	1.0	1.2
<b>Circle with rough surface or with projections</b> 		0.7	0.7	0.8	0.8	0.9	1.0	1.2

**D1.4 Longitudinal wind load**

**D1.4.1 General**

The nominal longitudinal wind load,  $P_L$ , should be taken as acting horizontally at the centroid of the area of the element.

**D1.4.2 Superstructures**

The nominal longitudinal wind load,  $P_L$ , should be taken as the most severe of either:

- 1) the nominal longitudinal wind load on the superstructure,  $P_{LS}$  ;
- 2) the sum of the nominal longitudinal wind load on the superstructure,  $P_{LS}$ , and the nominal longitudinal wind load on the live load,  $P_{LL}$ , derived separately.

The nominal longitudinal wind load on the superstructure,  $P_{LS}$ , should be derived in accordance with Equation D.9.

**Equation D.9 Nominal longitudinal wind load for superstructures**

$$P_{LS} = a \cdot 0.613 \cdot V_w^2 \cdot A_1 \cdot C_D$$

where:

- $a$                     0.25 for superstructures with solid elevation  
                          0.50 for truss girder superstructures
- $V_w$                     the wind speed for assessment (m/s)
- $A_1$                     the solid area for the superstructure in normal projected elevation, ignoring any parapets ( m<sup>2</sup> )
- $C_D$                     the drag coefficient

**D1.4.3 Live load**

The nominal wind load on live load,  $P_{LL}$ , should be derived in accordance with Equation D.10.

**Equation D.10 Nominal longitudinal wind load for live load**

$$P_{LL} = 0.5 \cdot 0.613 \cdot V_w^2 \cdot A_1 \cdot 1.45$$

where:

- $V_w$                     the wind speed for assessment (m/s)
- $A_1$                     the area of live load over the loaded length in normal projected elevation

**D1.4.4 Parapets and safety fences**

The nominal longitudinal wind load,  $P_L$ , should be determined in accordance with Table D.17, where  $P_T$  is the nominal transverse wind load on the element.

**Table D.17 Nominal longitudinal wind load for parapets and safety fences**

Parapet type	Nominal longitudinal wind load, $P_L$
With vertical infill members	$0.8 \cdot P_T$
With two or three horizontal rails	$0.4 \cdot P_T$
With mesh panels	$0.6 \cdot P_T$

**D1.4.5 Cantilever brackets extending outside main girders or trusses**

The nominal longitudinal wind load,  $P_L$ , should be determined from a horizontal wind acting at 45° to the longitudinal axis on the areas of each bracket not shielded by a fascia girder or adjacent bracket, using a drag coefficient taken from Figure D.8.

**D1.4.6 Piers**

The nominal longitudinal wind load,  $P_L$ , should be derived in accordance with Equation D.11.

**Equation D.11 Nominal longitudinal wind load for piers**

$$P_L = 0.613 \cdot V_w^2 \cdot A_2 \cdot C_D$$

where:

- $V_w$  the wind speed for assessment (m/s)
- $A_2$  the solid area in projected elevation normal to the longitudinal wind direction ( m<sup>2</sup> )
- $C_D$  the drag coefficient

**D1.5 Vertical wind load**

**D1.5.1 General**

The nominal vertical wind load,  $P_V$  , should be derived for all superstructures in accordance with Equation D.12.

**Equation D.12 Nominal vertical wind load**

$$P_V = 0.613 \cdot V_W^2 \cdot A_3 \cdot C_L$$

where:

- $V_W$  the wind speed for assessment (m/s)
- $A_3$  the area in plan ( m<sup>2</sup> )
- $C_L$  the lift coefficient

The nominal vertical wind load,  $P_V$  , should be taken as acting upwards or downwards at the centroid of the area of the element.

The lift coefficient,  $C_L$  , should be determined in accordance with Equation D.13.

**Equation D.13 Lift coefficient**

$$C_L = 0.75 \cdot \left( 1 - \frac{b}{20 \cdot d} \cdot (1 - 0.2 \cdot \alpha) \right)$$

where:

- $\alpha$  the sum of the angle of superelevation and the wind inclination, taken as a positive number irrespective of the inclination and superelevation
- $0.15 < C_L < 0.90$

Where the value of  $\alpha$  exceeds 10°, the lift coefficient,  $C_L$  , should be determined by testing.

**D1.6 Method for calculation of topography factor**

The topography factor,  $S'_h$  , accounts for local topographical features such as hills, valleys, cliffs, escarpments or ridges which can significantly affect the wind speed in their vicinity.

Values of the topography factor,  $S'_h$  , should be derived for each wind direction under consideration.

Where the topographic feature is of one of the forms shown in Figure D.2, the topography factor,  $S'_h$  , should be determined in accordance with Table D.18.

**Table D.18 Topography factor**

Wind speed for assessment, $V_w$	Topography factor, $S'_h$
Maximum wind gust speed, $V_d$	$1 + S_h \cdot \frac{S'_c \cdot T_c}{S'_b \cdot T_g}$
Hourly mean wind speed, $V_r$	$1 + S_h$
Where: $S_h$ is a topographic factor determined in accordance with Table D.19 $S'_c$ is the hourly speed factor, taken from Table D.8 $T_c$ is the hourly mean town reduction factor, taken from Table D.9 $S'_b$ is the bridge and terrain factor, taken from Table D.4 $T_g$ is the town gust reduction factor, taken from Table D.6	

The topographic factor,  $S_h$ , should be determined in accordance with Table D.19, where  $L_e$  is the effective length of the upwind slope.

**Table D.19 Topographic factor**

Location of bridge	Upwind slope, $\Psi_U$	Topographic factor, $S_h$
$-2.5L_e < X < 15L_e$	$0.05 < \Psi_U < 0.3$	$2.0 \cdot \Psi_U \cdot s$
	$\Psi_U > 0.3$	$0.6 \cdot s$
Otherwise	-	0.0

The effective length of the upwind slope,  $L_e$ , should be determined in accordance with Table D.20.

**Table D.20 Effective length of upwind slope**

Upwind slope, $\Psi_U$	Effective length, $L_e$
$0.05 < \Psi_U < 0.3$	$L_U$
$\Psi_U > 0.3$	$\frac{Z}{0.3}$

The topographic location factor,  $s$ , should be determined from:

- 1) Figure D.7 for hills and ridges;
- 2) Figure D.8 for cliffs and escarpments.

where  $H$  is the height of the bridge above local ground level.

Figure D.7 Topographic location factor for hills and ridges

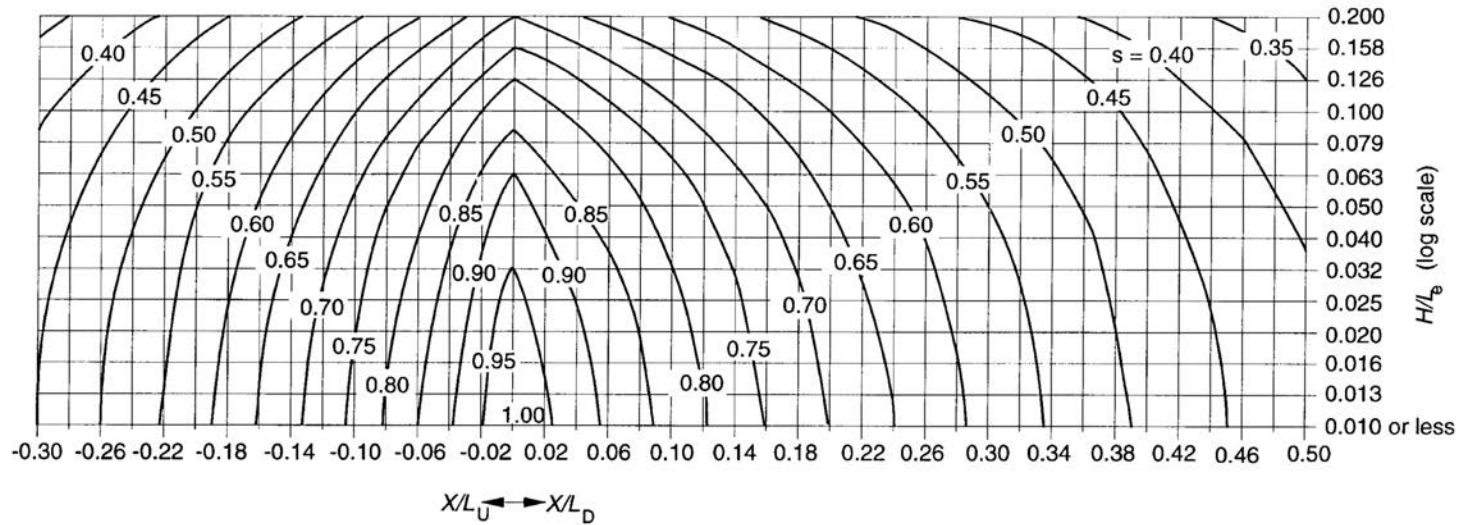
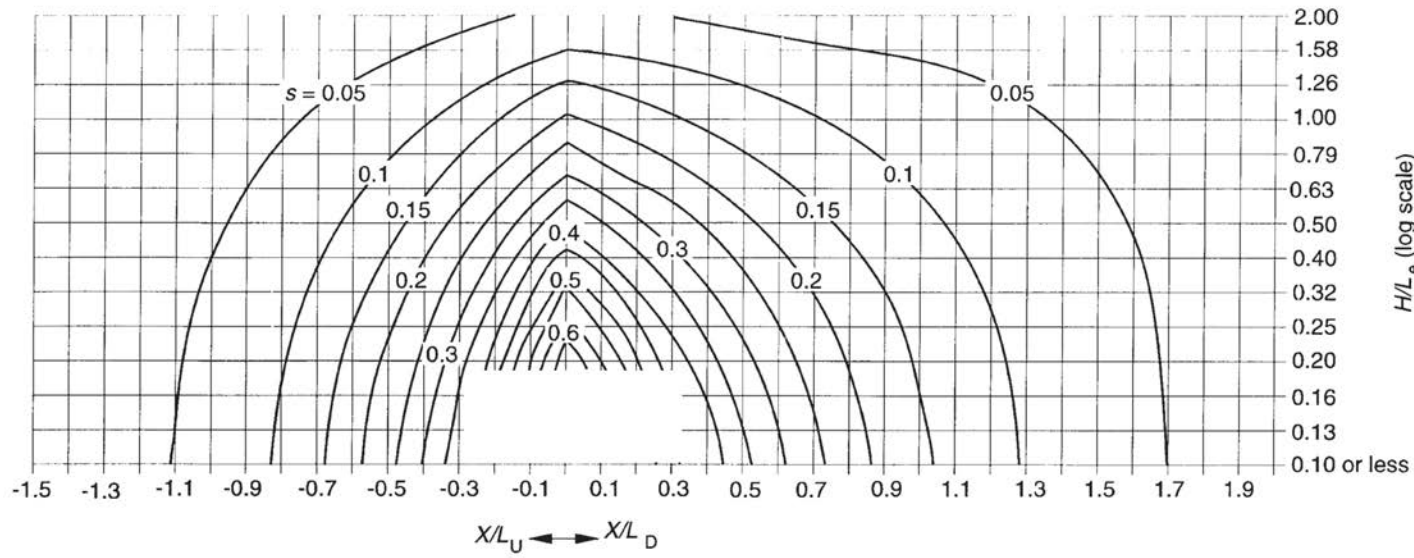
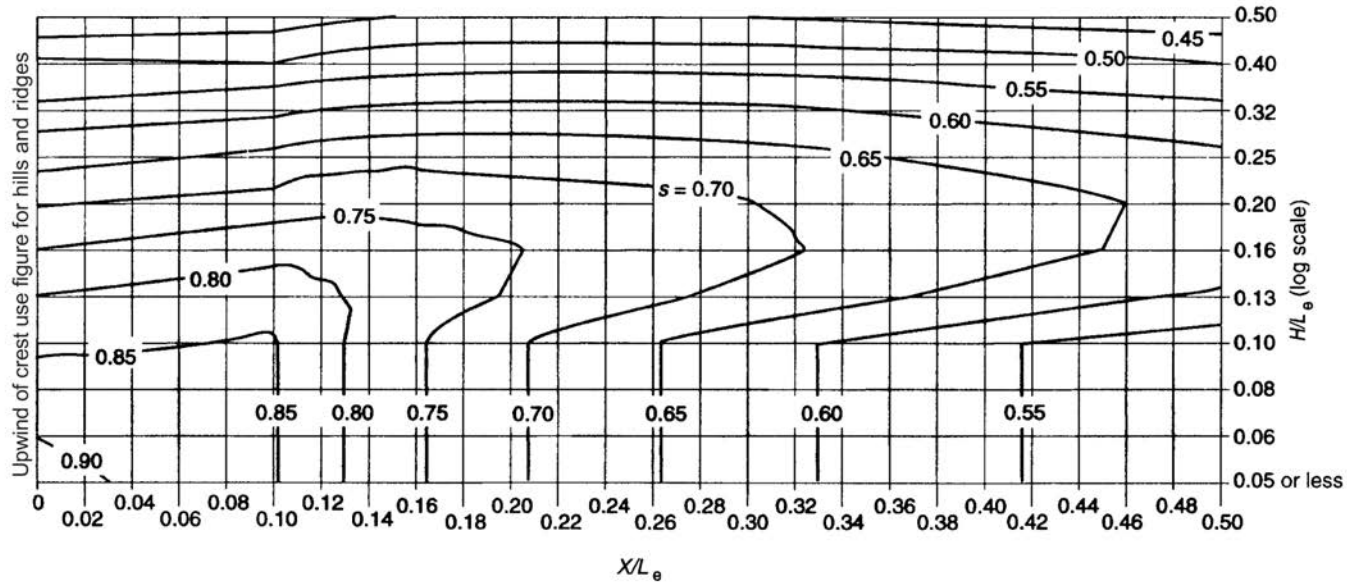
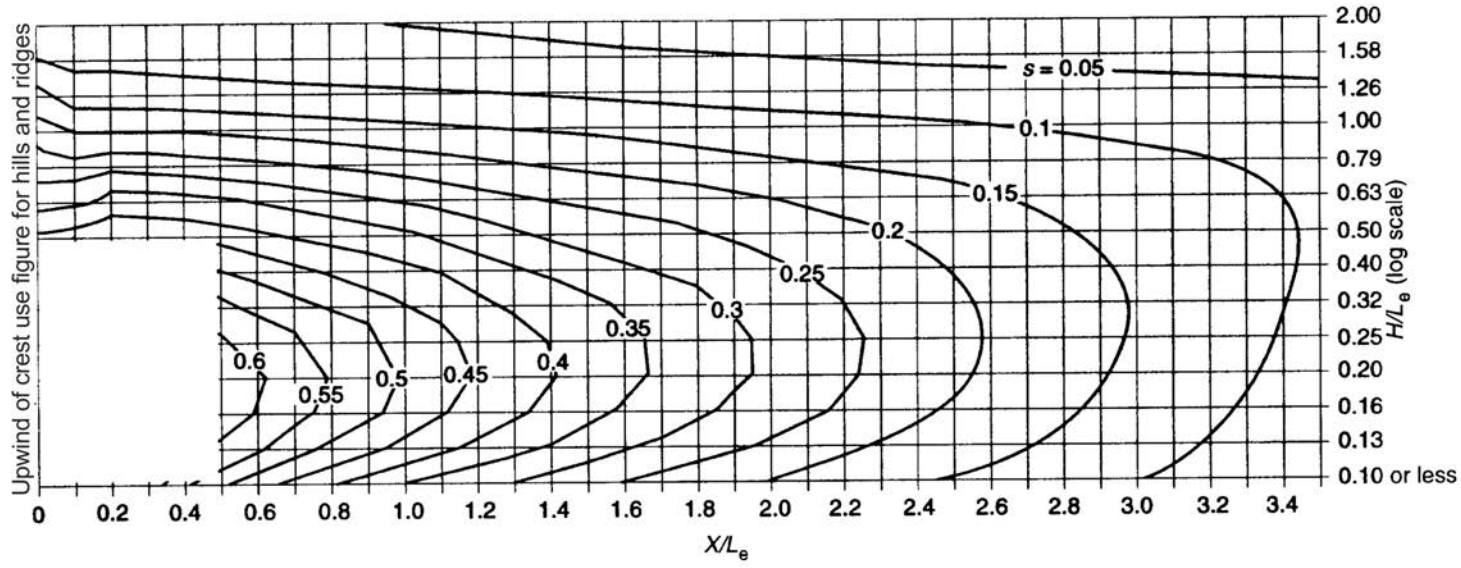

Figure D.8 Topographic location factor for cliffs and escarpments



**D2 Thermal loading****D2.1 General**

In this thermal loading model, the effects of temperature on a bridge superstructure are represented by the following components:

- 1) the effective temperature, which governs the superstructure's longitudinal movement;
- 2) temperature differences between the top surface and other vertical levels in the superstructure, which result in loads or load effects within the superstructure.

**D2.2 Effective temperatures**

The minimum and maximum effective bridge temperatures should be determined from the minimum and maximum shade air temperatures for the structure's location.

**D2.2.1 Shade air temperatures**

The minimum and maximum shade air temperatures for the structure's location should be determined from Figure D.9 and Figure D.10.

Figure D.9 Isotherms of minimum shade air temperature (°C)

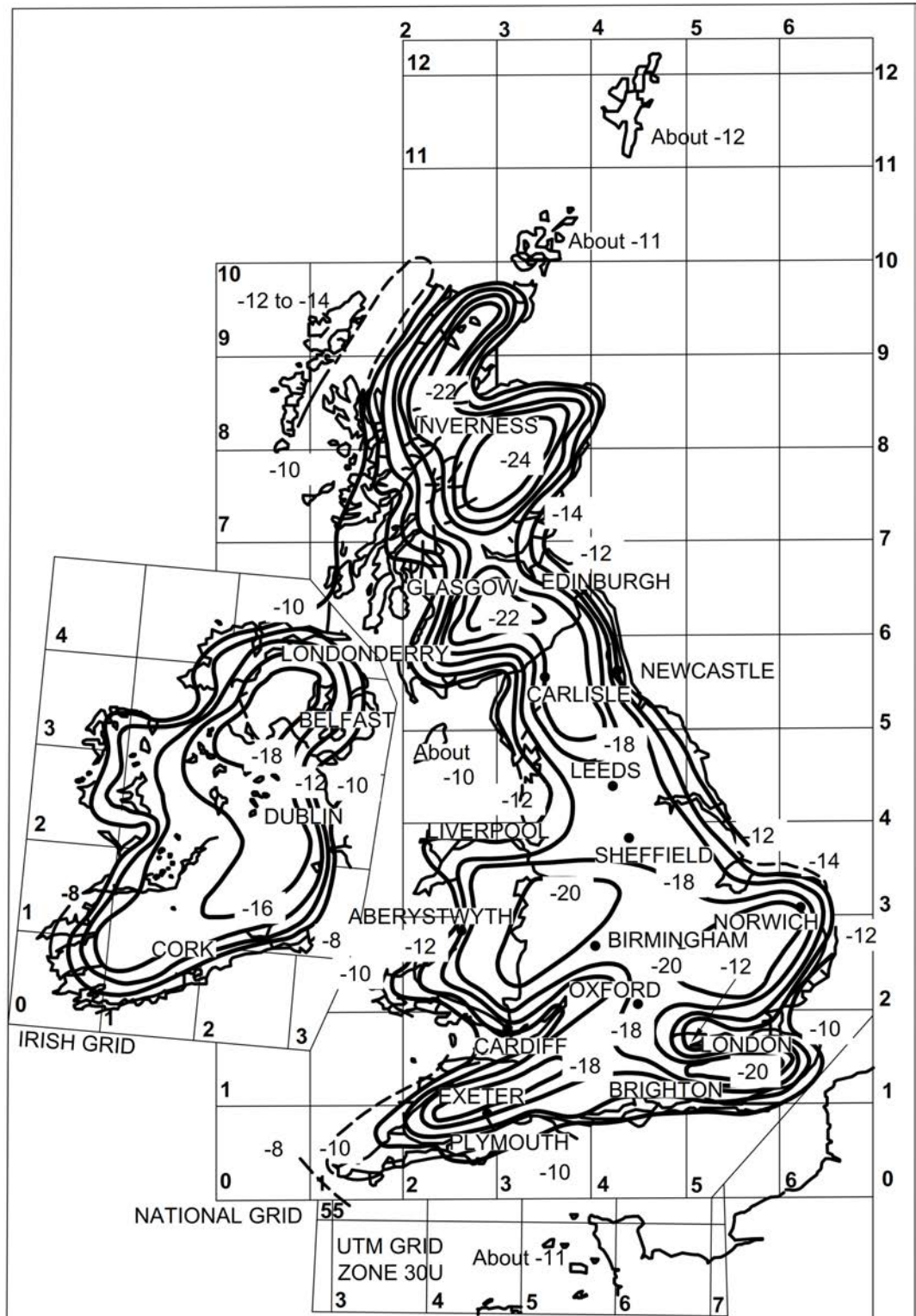

NOTE. The isotherms are derived from Meteorological Office data

Figure D.10 Isotherms of maximum shade air temperature (°C)

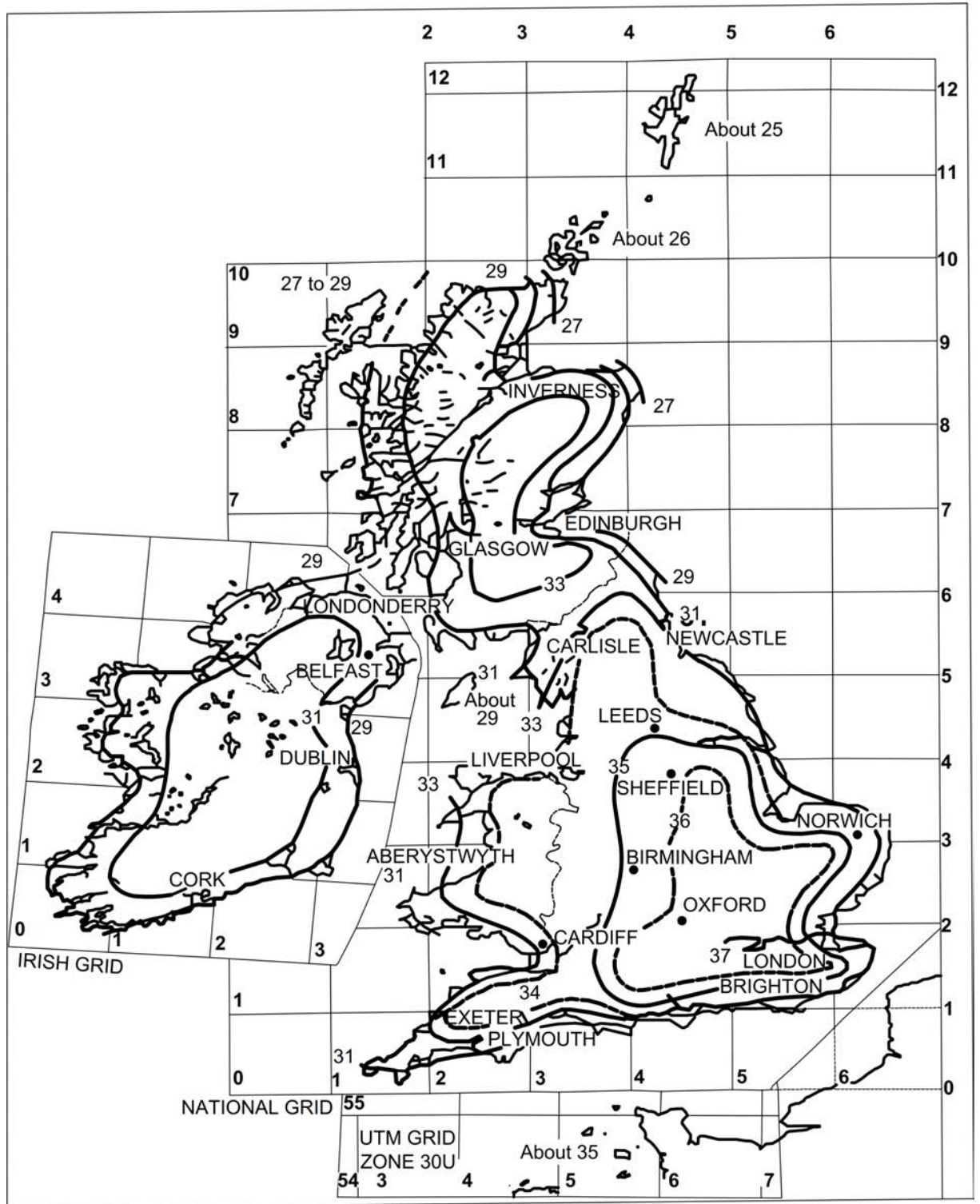

NOTE. The isotherms are derived from Meteorological Office data

The shade air temperatures given in Figure D.9 and Figure D.10 are applicable for a return period of 120 years, at mean sea level in open country.

Where the structure is a foot / cycle bridge, a return period of 50 years may be adopted by adding 2°C

to the minimum shade air temperature and subtracting 2°C from the maximum shade air temperature.

The values of shade air temperature should be adjusted for the height above sea level by subtracting 0.5°C per 100m height from the minimum shade air temperature and subtracting 1.0°C per 100m height from the maximum shade air temperature.

The minimum shade air temperature may be adjusted to account for the following situations:

- 1) areas where the minimum shade air temperature will be lower, such as frost pockets or sheltered low lying areas;
- 2) areas where the minimum shade air temperature will be higher, such as urban areas (except London), or coastal areas.

### D2.2.2 Effective bridge temperatures

The minimum and maximum effective bridge temperatures for different types of construction should be determined in accordance with Table D.21 and Table D.22.

**Table D.21 Minimum effective bridge temperature**

Minimum shade air temperature (°C)	Minimum effective bridge temperature (°C)			
	Type of superstructure			
	Group 1	Group 2	Group 3	Group 4
-24	-26	-25	-19	-14
-23	-25	-24	-18	-13
-22	-24	-23	-18	-13
-21	-23	-22	-17	-12
-20	-22	-21	-17	-12
-19	-21	-20	-16	-11
-18	-20	-19	-15	-11
-17	-19	-18	-15	-10
-16	-18	-17	-14	-10
-15	-17	-16	-13	-9
-14	-16	-15	-12	-9
-13	-15	-14	-11	-8
-12	-14	-13	-10	-7
-11	-13	-12	-10	-6
-10	-12	-11	-9	-6
-9	-11	-10	-8	-5
-8	-10	-9	-7	-4
-7	-9	-8	-6	-3
-6	-8	-7	-5	-3
-5	-7	-6	-4	-2

**Table D.22 Maximum effective bridge temperature**

Maximum shade air temperature (°C)	Maximum effective bridge temperature (°C)			
	Type of superstructure			
	Group 1	Group 2	Group 3	Group 4
24	38	34	31	27
25	39	35	32	28
26	40	36	33	29
27	41	37	34	29
28	42	38	34	30
29	43	39	35	31
30	44	40	36	32
31	45	41	36	32
32	46	42	37	33
33	47	43	37	33
34	48	44	38	34
35	49	45	39	35
36	50	46	39	36
37	51	47	40	36
38	52	48	40	37

The different groups of superstructure construction type are shown in Table D.24.

The minimum and maximum effective bridge temperatures should be adjusted to account for the thickness of any deck surfacing, in accordance with Table D.23.

**Table D.23 Adjustment to effective bridge temperature for deck surfacing**

Deck surface	Addition to minimum effective bridge temperature (°C)				Addition to maximum effective bridge temperature (°C)			
	Group 1	Group 2	Group 3	Group 4	Group 1	Group 2	Group 3	Group 4
Unsurfaced	0	0	-3	-1	+4	+2	0	0
Water-proofed	0	0	-3	-1	+4	+2	+4	+2
40mm surfacing	0	0	-2	-1	0	0	+2	+1
100mm surfacing	N/A	N/A	0	0	N/A	N/A	0	0
200mm surfacing	N/A	N/A	+3	+1	N/A	N/A	-4	-2

The effective bridge temperature at the time the structure was effectively restrained should be taken as datum when determining the effects of expansion up to the maximum effective bridge temperature and contraction down to the minimum effective bridge temperature.

### D2.3 Temperature differences

The effects of temperature differences with the superstructure should be determined in accordance with Table D.24, using the temperature values given in Tables D.25, D.26, D.27 and D.28.

**Table D.24 Vertical temperature differences for different types of construction**

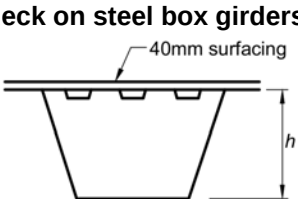
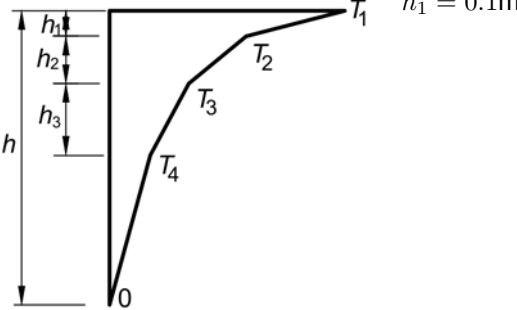
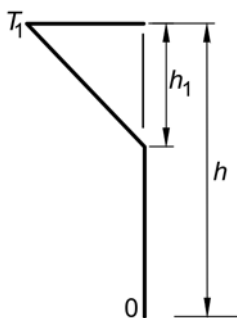
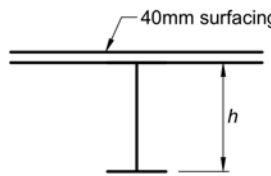
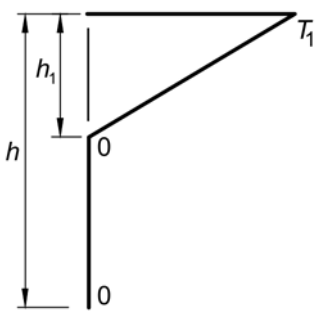
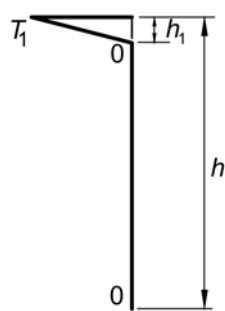
Group	Type of construction	Temperature profiles	
1	<p><b>Steel deck on steel box girders</b></p> 	<p><b>Positive temperature difference</b> <math>h_1 = 0.1\text{m}</math></p>  <p><math>h_2 = 0.2\text{m}</math> <math>h_3 = 0.3\text{m}</math></p>	<p><b>Reverse temperature difference</b> <math>h_1 = 0.5\text{m}</math></p> 
2	<p><b>Steel deck on steel truss or plate girders</b></p> 	<p><b>Positive temperature difference</b> <math>h_1 = 0.5\text{m}</math></p> 	<p><b>Reverse temperature difference</b> <math>h_1 = 0.1\text{m}</math></p> 

**Table D.24 Vertical temperature differences for different types of construction (continued)**

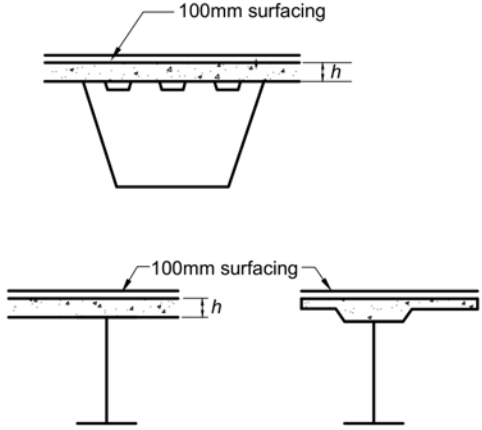
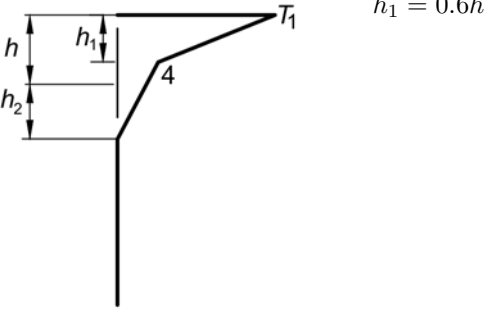
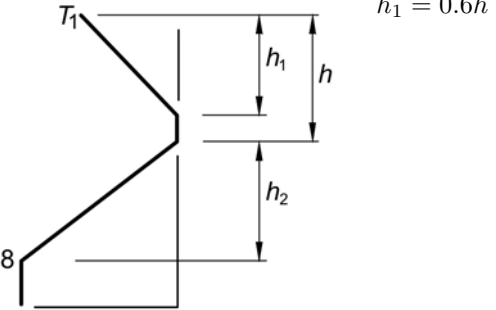
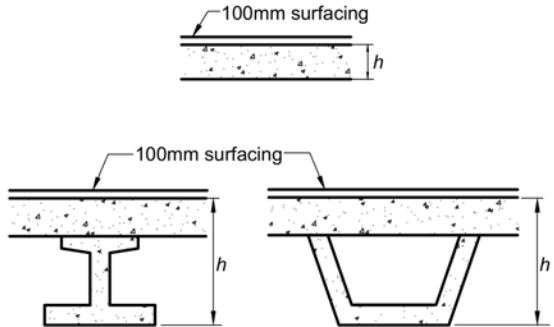
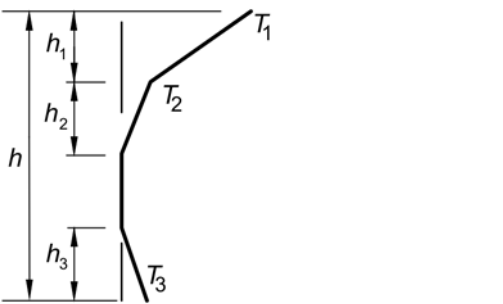
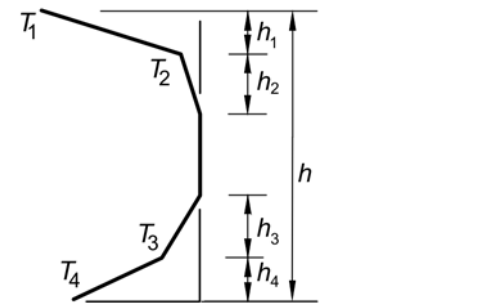
<p>3</p>	<p><b>Concrete deck on steel box, truss or plate girders</b></p> 	<p><b>Positive temperature difference</b></p>  <p><math>h_1 = 0.6h</math></p> <p><math>h_2 = 0.4m</math></p>	<p><b>Reverse temperature difference</b></p>  <p><math>h_1 = 0.6h</math></p> <p><math>h_2 = 0.4m</math></p>
<p>4</p>	<p><b>Concrete slab or concrete deck on concrete beams or box girders</b></p> 	<p><b>Positive temperature difference</b></p>  <p><math>h_1 = 0.3h</math> but <math>\leq 0.15m</math></p> <p><math>h_2 = 0.3h</math> but <math>\geq 0.1m</math> and <math>\leq 0.25m</math></p> <p><math>h_3 = 0.3h</math> but <math>\geq (0.1m + \text{surfacing depth in metres})</math></p> <p>(for thin slabs, <math>h_3</math> is limited by <math>h - h_1 - h_2</math>)</p>	<p><b>Reverse temperature difference</b></p>  <p><math>h_1 = h_4 = 0.20h</math> but <math>\leq 0.25m</math></p> <p><math>h_2 = h_3 = 0.25h</math> but <math>\leq 0.20m</math></p>

**Table D.25 Vertical temperature differences for group 1 structures**

Surface thickness (mm)	Positive temperature difference values (°C)				Reverse temperature difference values (°C)
	$T_1$	$T_2$	$T_3$	$T_4$	$T_1$
Unsurfaced	30	16	6	3	8
20	27	15	9	5	6
40	24	14	8	4	6

**Table D.26 Vertical temperature differences for group 2 structures**

Surface thickness (mm)	Positive temperature difference values (°C)	Reverse temperature difference values (°C)
	$T_1$	$T_1$
Unsurfaced	25	6
20	23	5
40	21	5

**Table D.27 Vertical temperature differences for group 3 structures**

Depth of slab (m)	Surface thickness (mm)	Positive temperature difference values (°C)	Reverse temperature difference values (°C)
$h$		$T_1$	$T_1$
0.2	Unsurfaced	16.5	5.9
	Waterproofed	23.0	5.9
	50	18.0	4.4
	100	13.0	3.5
	150	13.5	2.3
	200	8.5	1.6
0.3	Unsurfaced	18.5	9.0
	Waterproofed	26.5	9.0
	50	20.5	6.8
	100	16.0	5.0
	150	12.5	3.7
	200	10.0	2.7

Table D.28 Vertical temperature differences for group 4 structures

Depth of slab (m)	Surface thickness (mm)	Positive temperature difference values (°C)			Reverse temperature difference values (°C)			
		$T_1$	$T_2$	$T_3$	$T_1$	$T_2$	$T_3$	$T_4$
$h$								
< 0.2	Unsurfaced	12.0	5.0	0.1	4.7	1.7	0.0	0.7
	Waterproofed	19.5	8.5	0.0	4.7	1.7	0.0	0.7
	50	13.2	4.9	0.3	3.1	1.0	0.2	1.2
	100	8.5	3.5	0.5	2.0	0.5	0.5	1.5
	150	5.6	2.5	0.2	1.1	0.3	0.7	1.7
	200	3.7	2.0	0.5	0.5	0.2	1.0	1.8
0.4	Unsurfaced	15.2	4.4	1.2	9.0	3.5	0.4	2.9
	Waterproofed	23.6	6.5	1.0	9.0	3.5	0.4	2.9
	50	17.2	4.6	1.4	6.4	2.3	0.6	3.2
	100	12.0	3.0	1.5	4.5	1.4	1.0	3.5
	150	8.5	2.0	1.2	3.2	0.9	1.4	3.8
	200	6.2	1.3	1.0	2.2	0.5	1.9	4.0
0.6	Unsurfaced	15.2	4.0	1.4	11.8	4.0	0.9	4.6
	Waterproofed	23.6	6.0	1.4	11.8	4.0	0.9	4.6
	50	17.6	4.0	1.8	8.7	2.7	1.2	4.9
	100	13.0	3.0	2.0	6.5	1.8	1.5	5.0
	150	9.7	2.2	1.7	4.9	1.1	1.7	5.1
	200	7.2	1.5	1.5	3.6	0.6	1.9	5.1
0.8	Unsurfaced	15.4	4.0	2.0	12.8	3.3	0.9	5.6
	Waterproofed	23.6	5.0	1.4	12.8	3.3	0.9	5.6
	50	17.8	4.0	2.1	9.8	2.4	1.2	5.8
	100	13.5	3.0	2.5	7.6	1.7	1.5	6.0
	150	10.0	2.5	2.0	5.8	1.3	1.7	6.2
	200	7.5	2.1	1.5	4.5	1.0	1.9	6.0
1.0	Unsurfaced	15.4	4.0	2.0	13.4	3.0	0.9	6.4
	Waterproofed	23.6	5.0	1.4	13.4	3.0	0.9	6.4
	50	17.8	4.0	2.1	10.3	2.1	1.2	6.3
	100	13.5	3.0	2.5	8.0	1.5	1.5	6.3
	150	10.0	2.5	2.0	6.2	1.1	1.7	6.2
	200	7.5	2.1	1.5	4.8	0.9	1.9	5.8
> 1.5	Unsurfaced	15.4	4.5	2.0	13.7	1.0	0.6	6.7
	Waterproofed	23.6	5.0	1.4	13.7	1.0	0.6	6.7
	50	17.8	4.0	2.1	10.6	0.7	0.8	6.6
	100	13.5	3.0	2.5	8.4	0.5	1.0	6.5
	150	10.0	2.5	2.0	6.5	0.4	1.1	6.2
	200	7.5	2.1	1.5	5.0	0.3	1.2	5.6

**D2.4 Combining temperature differences with effective temperature**

Positive temperature differences should be taken to coexist with effective bridge temperatures above 25°C for groups 1 and 2, and 15°C for groups 3 and 4.

Reverse temperature differences should be taken to coexist with effective bridge temperatures up to 8°C below the maximum for groups 1 and 2, up to 4°C below the maximum for group 3, and up to 2°C below the maximum for group 4.

**D2.4.1 Deriving maximum temperatures for calculation of loads or load effects**

The maximum temperatures within the superstructure, to be used in the calculation of loads or load effects should be determined using the following process:

- 1) determine the maximum effective bridge temperature,  $X$  ;
- 2) determine the positive temperature difference distribution through the superstructure;
- 3) using the positive temperature difference distribution, the geometry of the superstructure, and Appendix 1 of TRRL Laboratory Report 765 [Ref 25.I], determine the equivalent effective bridge temperature,  $Y$  ;
- 4) add  $(X - Y)$  to all the temperatures determined in step (2).

**D2.4.2 Deriving minimum temperatures for calculation of loads or load effects**

The minimum temperatures within the superstructure, to be used in the calculation of loads or load effects should be determined using the following process:

- 1) determine the minimum effective bridge temperature,  $X$  ;
- 2) determine the reverse temperature difference distribution through the superstructure, assuming all temperature values to be negative;
- 3) using the reverse temperature difference distribution, the geometry of the superstructure, and Appendix 1 of TRRL Laboratory Report 765 [Ref 25.I], determine the equivalent effective bridge temperature,  $Y$  ;
- 4) add  $(X - Y)$  to all the temperatures determined in step (2).

## Appendix E. Assessment of masonry arches using the modified MEXE method

### E1 Introduction and method of assessment

The modified MEXE method is a simple empirical method, originally developed by the Military Engineering Experimental Establishment for assessing the capacity of single span masonry arch barrels up to 18m span for carrying military traffic.

The modified MEXE method is based on theoretical studies carried out by Pippard AJS in [Ref 26.] and supported by observation of arches under actual live loads. The method takes account of the condition of the arch barrel using different factors, and has been further modified to suit normal civilian highway traffic starting from the method set out in [Ref 19.] .

The modified MEXE method uses a nomogram, or alternatively an equation, to obtain a provisional permissible axle loading (PAL), depending on the span, ring thickness and depth of fill. This value is then modified by factors which allow for the influence of other important parameters.

The method deals with the assessment of the arch barrel only.

The overall resistance of the bridge can also be affected by the strength of other parts of the structure, including the spandrel walls, wing walls and foundations.

Restrictions on the use of the modified MEXE method are given in Section 7.

The initial assessment is in terms of a maximum allowable axle load on an axle forming part of a double axled bogie. This first initial maximum allowable axle load is then factored for converting this result to other axle configurations and for situations where axle lift-off may occur on the axle of a multiple-axle bogie.

### E2 Theory

Prior to the introduction of computers, the calculations for predicting the long term resistance of a masonry arch were difficult to handle. This led to the development of an empirical formula based on arch dimensions.

The arch is first assumed to be parabolic in shape with span/rise ratio of 4, soundly built in good quality brickwork/stonework, with well pointed joints, to be free from cracks, and to have adequate abutments. For such an idealised arch, a provisional assessment is obtained from a nomogram (Figure E.1) or using an equation. This provisional assessment value is then modified by factors which allow for the way in which the actual arch differs from the ideal one.

Figure E.1 Nomogram for determining the provisional axle loading for masonry arch bridges before factoring

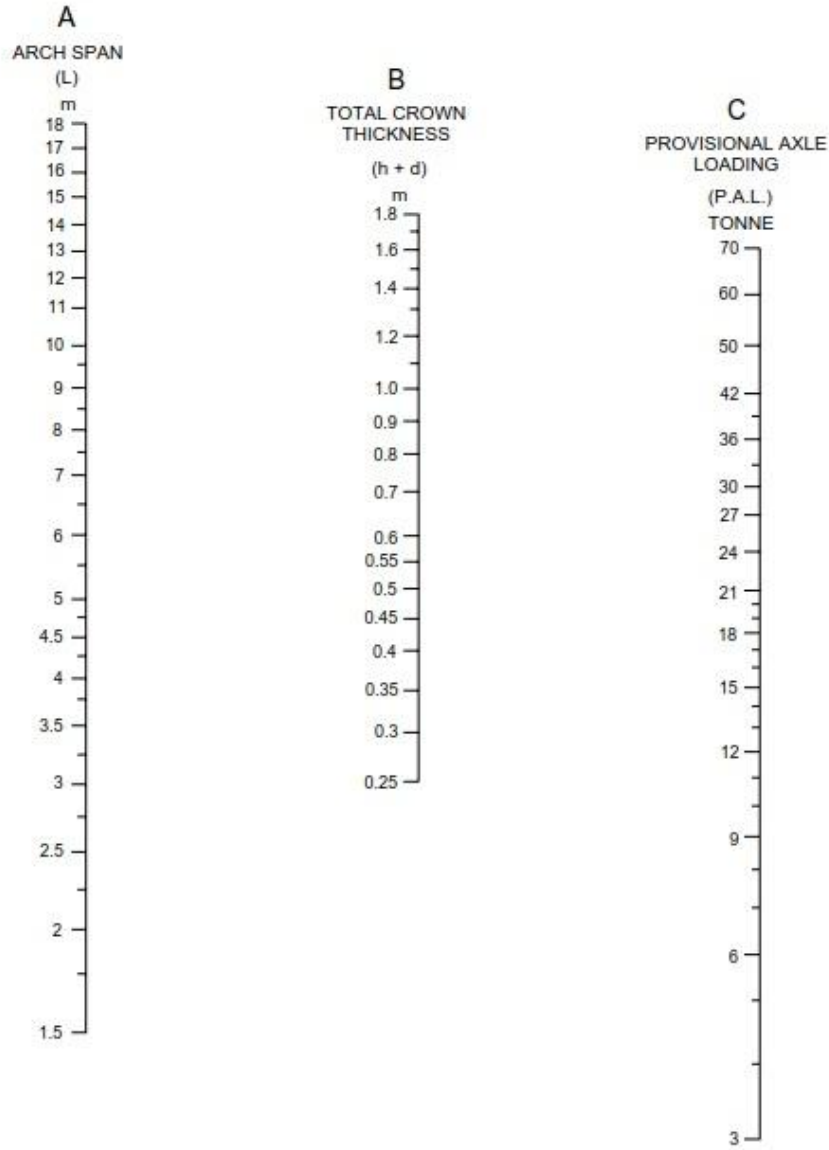

**E3 Survey of the arch**

The arch should be inspected in accordance with the requirements for inspection for assessment in Section 2 and the following dimensions measured, as shown in Figure E.2:

- 1) the span  $L$  ;
- 2) the rise of the arch barrel at the crown  $r_c$  ;
- 3) the rise of the arch barrel at the quarter points  $r_q$  ;
- 4) the thickness of the arch barrel adjacent to the keystone  $d$  ;
- 5) the average depth of fill, at the quarter points of the transverse road profile, between the road surface and the arch barrel at the crown, including road surfacing  $h$  .

The following information will also be needed to derive the various modifying factors:

- 1) material used for the arch barrel;
- 2) type of construction of the barrel (i.e. voussoirs in courses or laid at random);
- 3) condition of materials in the barrel (i.e. presence of significant spalling and possible weathering of the voussoirs);
- 4) deformation of the barrel from its original shape:
  - a) positions of dropped voussoirs and amount of drop;
  - b) width, length, number and positions of cracks;
  - c) type of filling above the arch and its condition;
  - d) position and size of services;
  - e) width of mortar joints;
  - f) depth of mortar missing from joints;
  - g) condition of joint mortar.

**Figure E.2 Arch dimensions**

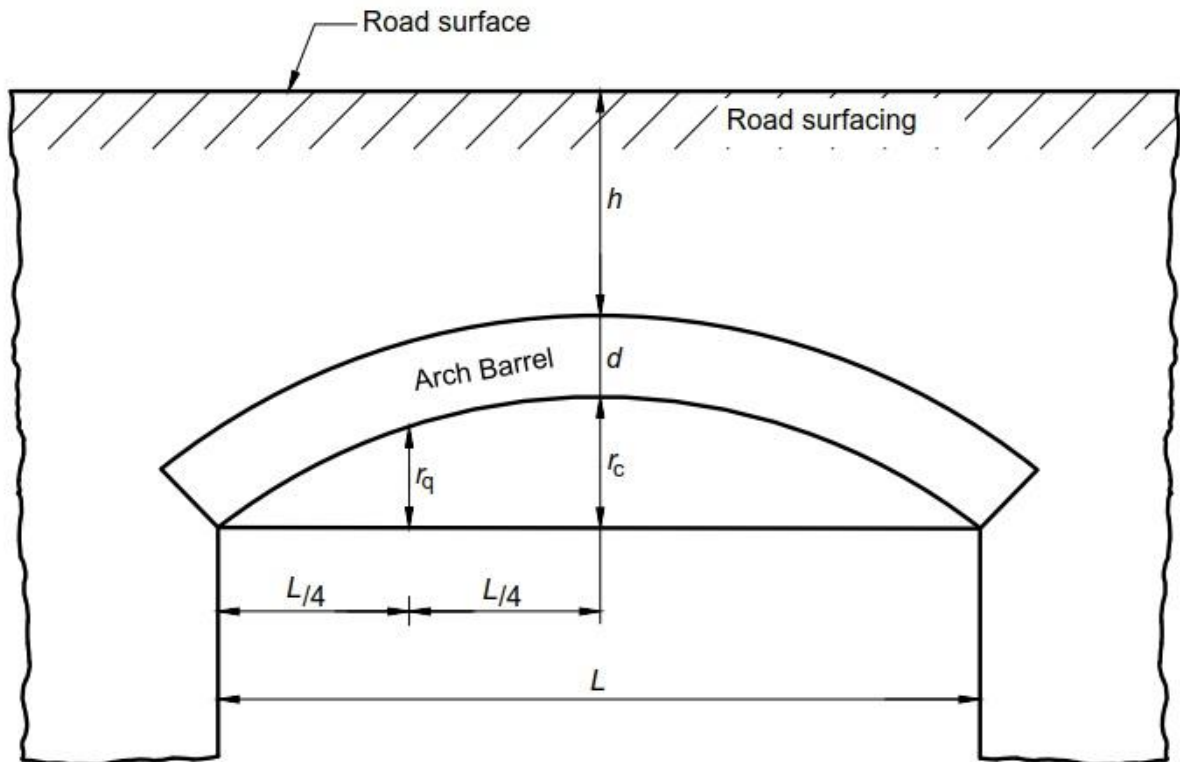

Radial displacement of individual stones or bricks, especially near the crown when there is little cover, should be noted with particular attention. Displacement may be due to uneven masonry projecting above the barrel and being subjected to concentrated loads or a hard spot such as a pipe flange bearing directly on the arch. The damage is usually localised and not serious if dealt with before it has progressed too far. If, however, there are a number of voussoirs displaced, then this should be taken into account and the thickness of the arch barrel adjusted accordingly.

Note should be taken of any evidence of separation of the arch rings, particularly with regard to any additional rings which have been constructed in later years. This should be reported and taken into account for the value assumed for the arch barrel thickness.

**E4 Provisional assessment**

When the PAL is obtained from the nomogram of Figure E.1 the procedure is the following:

- 1) mark the arch span  $L$  on column A and the total crown thickness  $(d + h)$  on column B;
- 2) line through these points to column C;
- 3) read off the PAL in tonnes.

Alternatively, the provisional axle loading in tonnes may be obtained by substituting the values of  $(d + h)$  and  $L$  in Equation E.1:

**Equation E.1 Provisional axle loading**

$$PAL = \min \left\{ \frac{740(d + h)^2}{L^{1.3}}; 70 \right\}$$

where:

$d, h$  and  $L$  are in metres;  
 $PAL$  is in tonnes.

This expression has been derived from the nomogram and should only be used within the limits given in Figure E.1, and a modified axle load is then derived by applying modifying factors and the condition factor to the value of the PAL.

**E5 Modifying factors**

**E5.1 Span/rise factor ( $F_{sr}$ )**

Flat arches are not so strong under a given loading as those of steeper profile, and the provisional assessment should, therefore, be adjusted. A span/rise ratio of 4 and less is assumed to give optimum strength and has a span/rise factor ( $F_{sr}$ ) of 1.

Where the span/rise ratio is greater than 4, the span/rise factor  $F_{sr}$  should be taken from Figure E.3 for the different ratios.

Figure E.3 Span/Rise factor

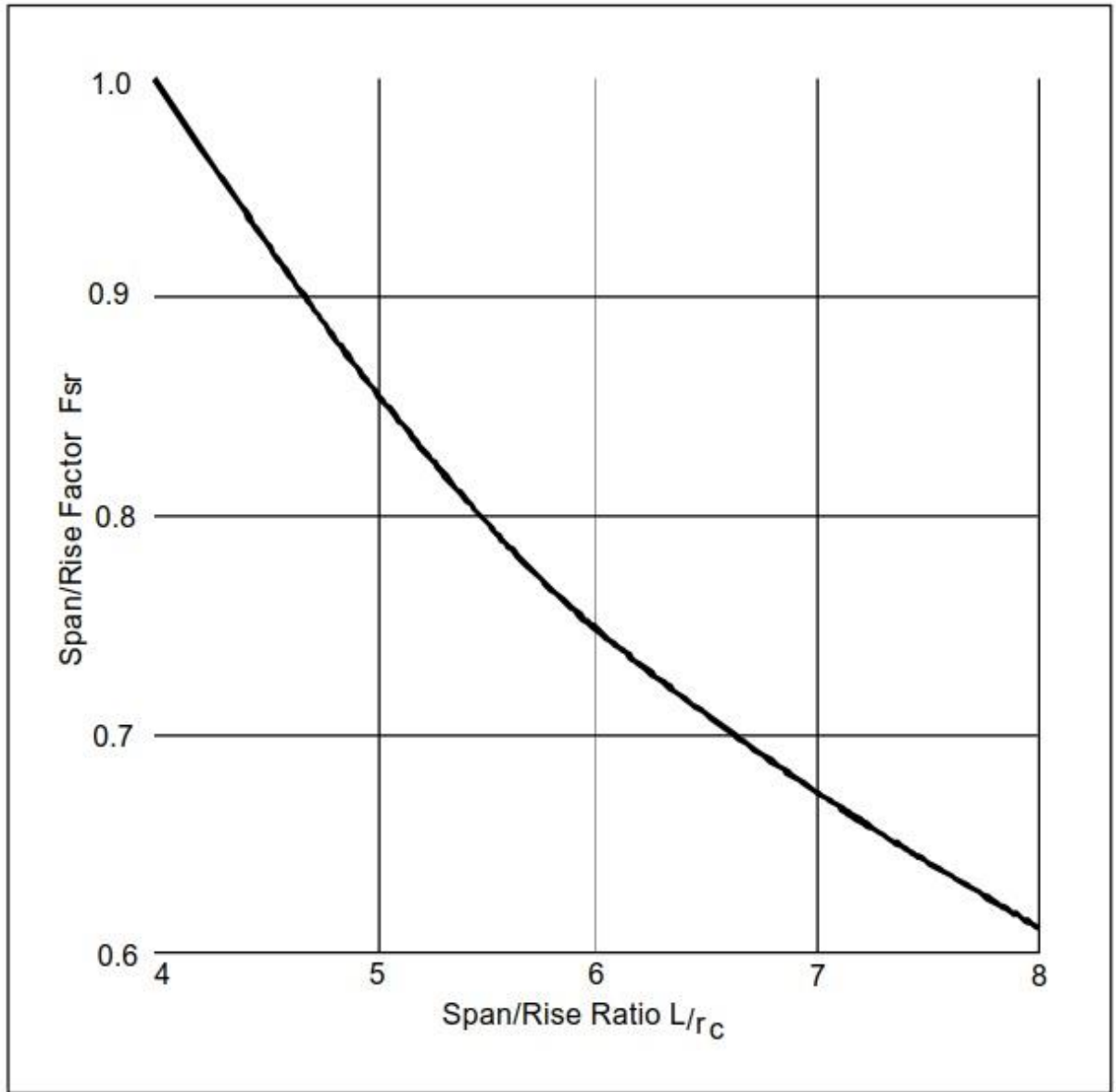

**E5.2**

**Profile factor ( $F_p$ )**

There is evidence that elliptical arches are not so strong as segmental and parabolic arches of similar span/rise ratio and barrel thickness. The ideal profile has been taken to be parabolic and for this shape the rise at the quarter points,  $r_q = 0.75 \cdot r_c$ , where  $r_c$  is the rise at the crown.

The profile factor should be taken as  $F_p = 1$  if  $r_q/r_c \leq 0.75$ , or from Equation E.2 where  $r_q/r_c > 0.75$  :

**Equation E.2 Profile factor**

$$F_p = 2.3 \left[ \frac{r_c - r_q}{r_c} \right]^{0.6}$$

The values of the profile factor  $F_p$  have also been plotted in Figure E.4 for convenience.

Figure E.4 Profile factor

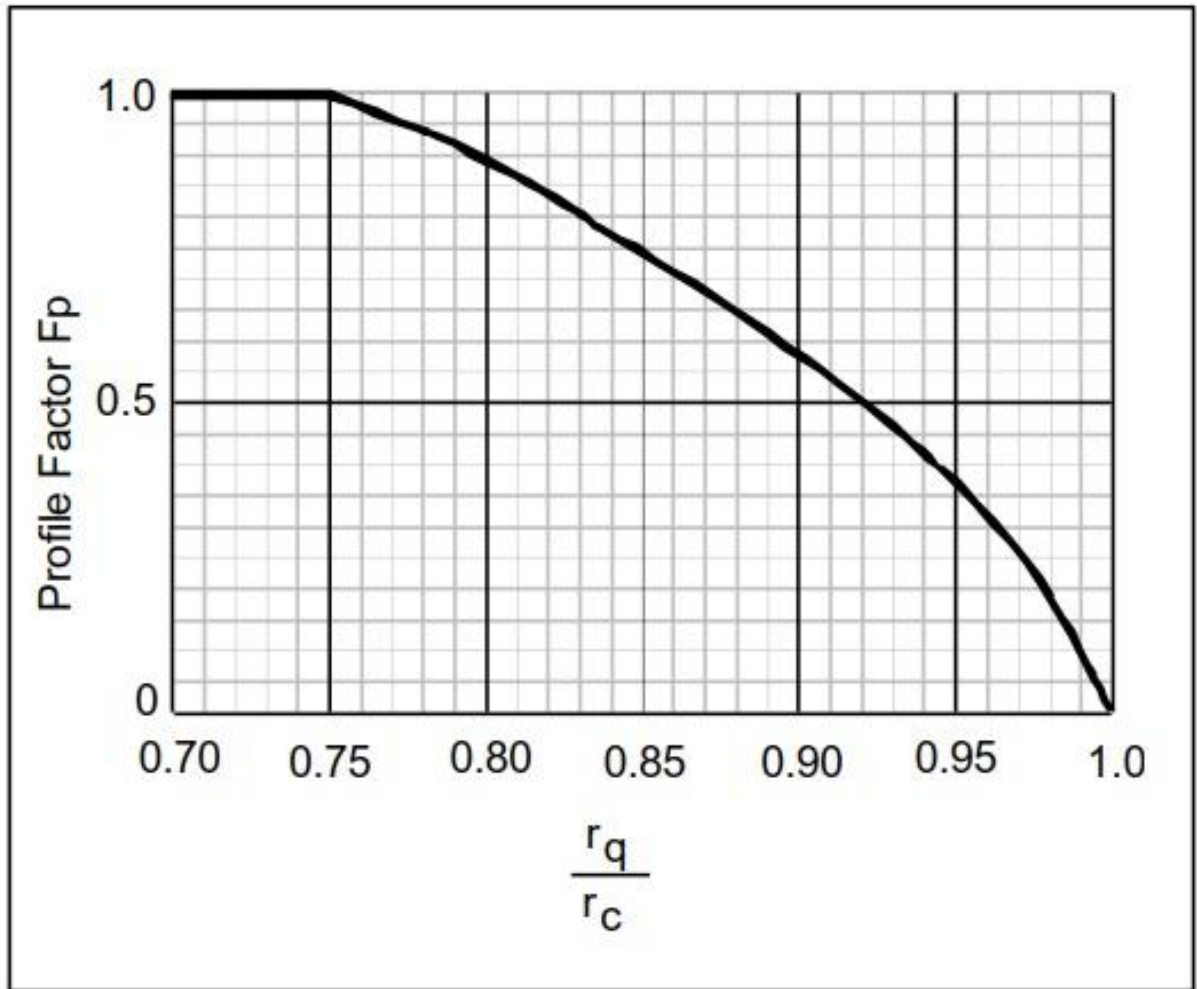

**E5.3 Material factor ( $F_m$ )**

The material factor is obtained from Equation E.3:

**Equation E.3 Material factor**

$$F_m = \frac{(F_b \cdot d) + (F_f \cdot h)}{d + h}$$

where:

$F_b$  is the barrel factor obtained from Table E.1

$F_f$  is the fill factor obtained from Table E.2

**Table E.1 Barrel factor**

Arch barrel	Barrel factor ( $F_b$ )
Granite and Whinstone whether random or coursed and all built-in-course masonry except limestone, all with large shapes voussoirs	1.5
Ashlar quality siliceous sandstone	1.4
Concrete <sup>1</sup> or engineering bricks and similar sized masonry (not limestone)	1.2
Limestone, whether random or coursed, ashlar quality calcareous sandstone, good random masonry and building bricks, all in good condition	1.0
Masonry of any kind in poor condition (many voussoirs flaking or badly spalling, shearing etc). Some discretion is permitted if the dilapidation is only moderate	0.7
Note 1: Concrete arches will normally be of relatively recent construction and their assessment should be based on the design calculations if these are available.	

**Table E.2 Fill factor**

Filling	Fill factor ( $F_f$ )
Concrete <sup>1</sup>	1.0
Grouted materials (other than those with a clay content)	0.9
Well compacted materials <sup>2</sup>	0.7
Weak materials evidenced by tracking of the carriageway surface	0.5
Note 1: The fill factor for concrete is less than the barrel factor to allow for possible lack of bond to the arch Note 2: Unless details of the fill are known or there is evidence of weakness from the condition of the road surface, it is recommended that this factor be adopted. If the arch then requires a restriction, further investigation should be made to see if the strength may be increased.	

Apart from frost action, an arch which is constantly wet, or shows signs that damp often penetrates, is unlikely to have suffered deterioration from this cause alone unless the seepage contains reactive chemicals which may have affected the materials of construction; in this case the value of the barrel factor should account for that.

Some local damage may be offset by evidence that the structure was built with good materials and workmanship. Such evidence would be:

- 1) durable masonry set in its correct bed;
- 2) well shaped durable bricks;
- 3) correct bonding of brickwork or masonry with regular and narrow joints;
- 4) original documents showing liberal haunching at the abutments and a good specification.

The fill factor  $F_f$  should also account for any leaching from fill material above the arch due to presence of water.

#### **E5.4 Joint factor ( $F_j$ )**

The joint factor  $F_j$  should be taken in accordance with Section 7.

#### **E5.5 Arch barrel condition factor ( $F_{cM}$ )**

The arch barrel condition factor should be taken in accordance with Section 7.

## E6 Cracks, deformations and defects

Cracks or deformations which may have occurred soon after the bridge was built are not usually as serious as those which are recent, and show clean faces, possibly with loose fragments of masonry.

Where the deterioration is suspected to be progressive, frequent careful observations may be necessary before arriving at a final assessment. Cracks may on occasion be formed in the mortar only and it is important that cracking and joint deficiencies should not be confused with each other.

It is also important to differentiate between those defects which affect the load carrying capacity of the arch barrel and other defects which do not affect the load carrying capacity of the barrel but can affect the stability of the road surface.

### E6.1 Defects affecting the stability and load carrying capacity of the arch barrel

These defects are listed in the Table 7.5.1a for the arch barrel condition factor  $F_{cM}$  in Section 7.

### E6.2 Defects affecting the stability of the road surface

Defects which do not affect the stability of the arch barrel but may affect the stability of the road surface are indicated below:

- 1) longitudinal cracks near the edge of the arch barrel are signs of movement between the arch and spandrel or bulging of the spandrel, caused by the lateral spread of the fill exerting an outward force on the spandrels. This is a frequent source of weakness in old arch bridges and the proximity of the carriageway to the parapet should be taken into account when assessing its importance;
- 2) movement or cracking of the wing walls is another common source of weakness in old bridges and occurs for similar reasons to longitudinal cracks described at point 1 above;
- 3) where the bridge consists of multi-span arches and the strength of intermediate piers is in doubt, the structure should be examined for cracks and deformation arising from any weakness in the piers.

## E7 Application

The span/rise profile, material, joint and condition factors should be applied together with the  $PAL$  obtained from Equation E.1 or , alternatively, from Figure E.1 in order to determine the modified axle load ( $MAL$ ) which represents the allowable loading (per axle) on the arch from a double axled bogie configuration with no 'lift-off' from any axle.

### Equation E.4 Modified axle load

$$MAL = F_{sr} \cdot F_p \cdot F_m \cdot F_j \cdot F_{cM} \cdot PAL$$

The unrounded value of  $MAL$  should be multiplied by the appropriate axle factors  $A_f$  from Figure E.5 to give the allowable axle loads for single and multiple axles with no 'lift off', and Figure E.6 for the 'lift-off' case. The 2 axle bogie case is the most onerous.

Figure E.5 Axle factor for no axle lift-off

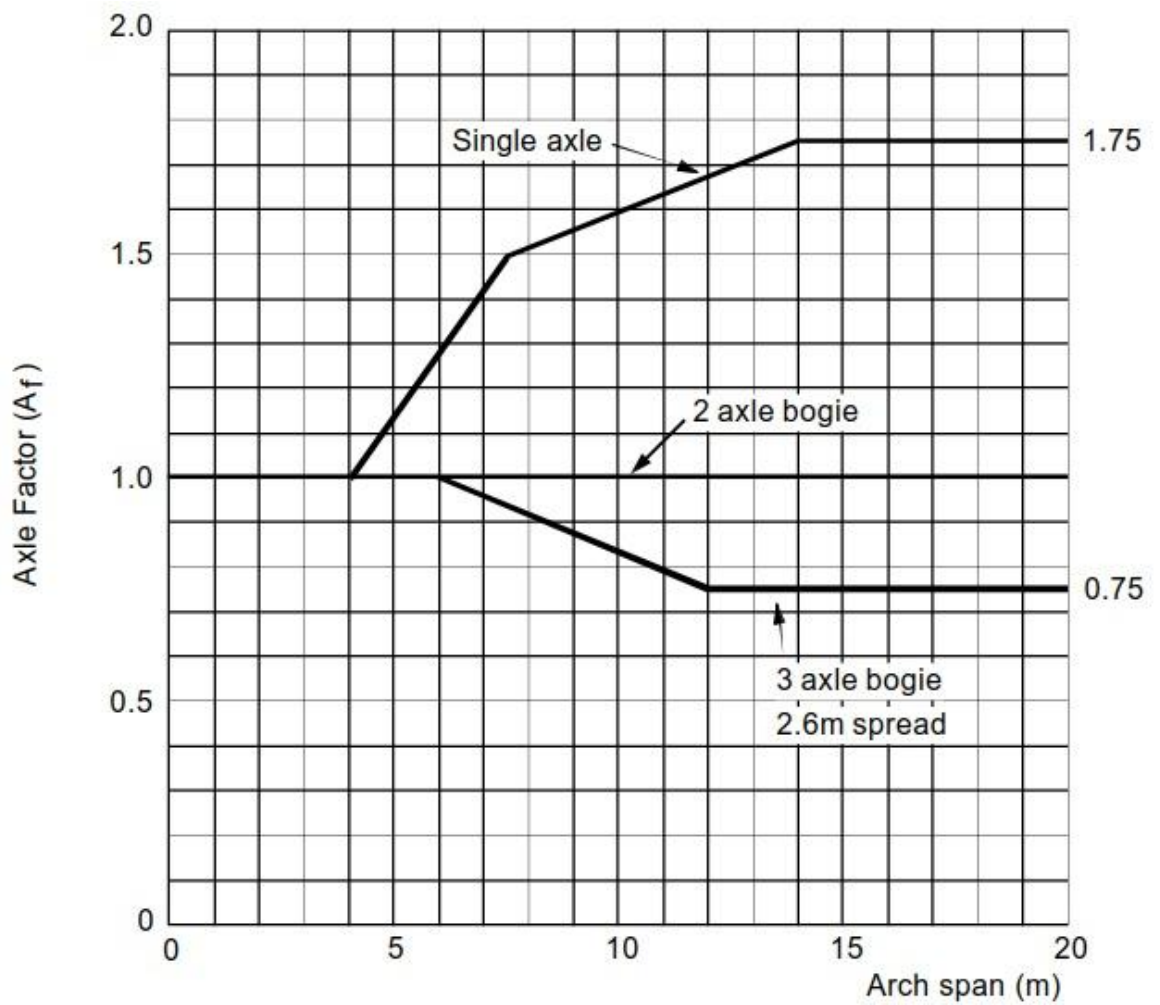
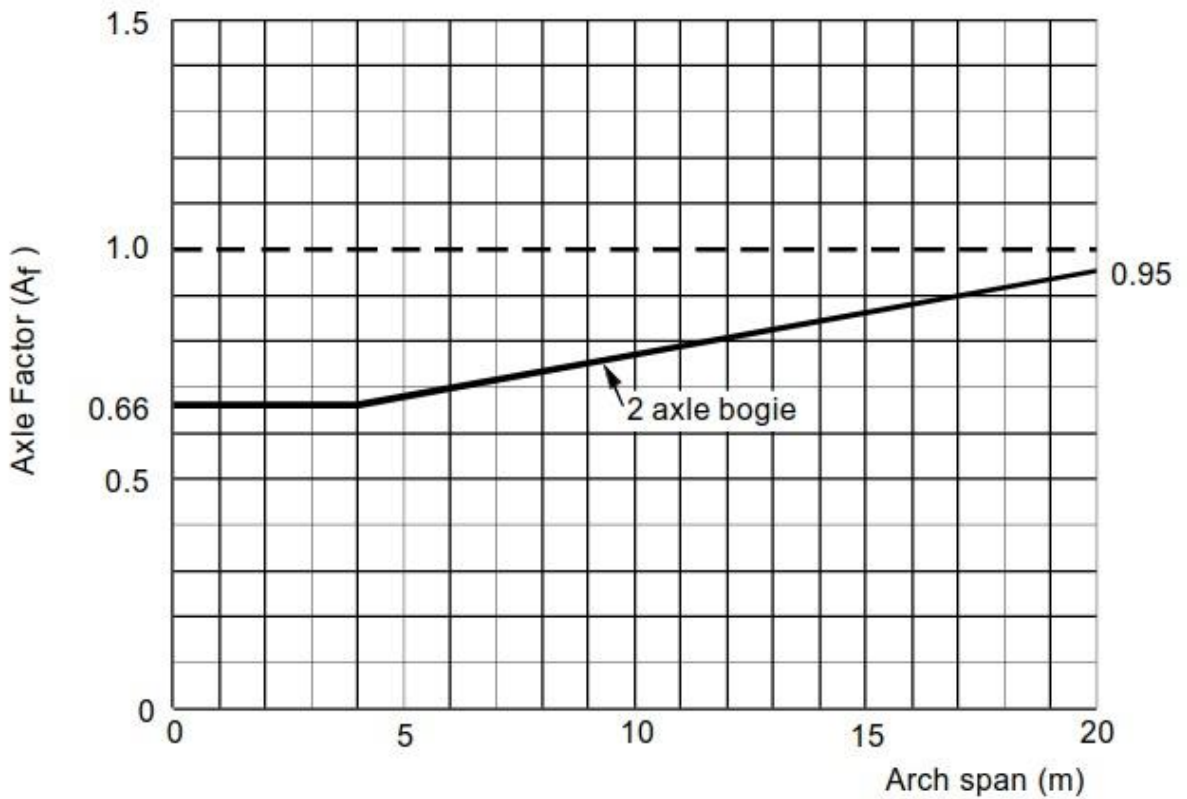

Figure E.6 Axle factor for axle lift-off



It should be noted that these allowable axle loads may not represent the strength of the bridge as a whole. This may be affected by the strength of the spandrel walls, and other components. Should the strength of any of these items be assessed as being lower than the barrel strength, then the lowest value should be taken as the strength of the bridge as a whole.

**E8 Axle lift-off**

The axle factors  $A_f$  given in Figures E.5 and E.6 cover two situations. The first, the 'no lift-off' case, is the more usual when all the wheels of the vehicle are assumed to be in full contact with the road surface at all times. The 'lift-off' case relates to circumstances when the wheels of a double or triple axled bogie can partially lose contact with the road surface and transfer some of their load to other axles in the bogie. Examples of the circumstances which may bring about this phenomenon are given below. The road condition should be inspected to determine whether or not 'lift-off' should be taken into account. The presence of any of the following conditions could lead to the adoption of a 'lift-off' case:

- 1) a vertical road alignment with significant changes from positive to negative gradient over a short distance (e.g. a humped back bridge);
- 2) arch located at the bottom of a hill or on a straight length of road where approach speeds are likely to be high;
- 3) irregularities in road surface on the arch.

**E9 Curved carriageways**

Where the carriageway on an arch is horizontally curved, an allowance for the effects of any increase in vertical loading caused by centrifugal effects should be made by dividing the allowable axle weight by the centrifugal effects factor  $F_A$  derived in accordance with Section 5. Centrifugal effects may be ignored when the radius of curvature of the carriageway exceeds 600m.

**E10 Assessment resistance and weight restrictions**

To find the resistance of an arch, the allowable axle loads determined in accordance with the indications given in this section from E.4 to E.8, should first be rounded off to the nearest 0.5 tonnes. The capacity of an arch should be determined in terms of gross vehicle weight from Table E.3.

**Table E.3 Load capacity and weight restrictions for masonry arches**

Allowable axle load per axle (tonnes)			Max gross vehicle weight (gvw) (tonnes)	Weight restriction (tonnes)
Single axle	Double axle bogie	Triple axle bogie		
11.5	10	8 <sup>[1]</sup>	40/44	N/A
11.5	9.5	-	32	33
11.5	9.5	-	26	26
11.5	-	-	18	18
9	-	-	12.5	13
7	-	-	10	10
5.5	-	-	7.5	7.5
2	-	-	3	3

Note 1: An assessment for the 24 tonne 3 axle bogie (8 tonnes axle) is only necessary for arches where "no axle lift-off" conditions prevail.

## Appendix F. Partial factor and reliability-based methods of assessment

### F1 Introduction to methods of assessment

#### F1.1 Partial factor method

This document is based on the partial factor method (sometimes referred to as a deterministic method) as a means of verifying structural safety in an assessment. The partial factors to be used for assessment are specified in Section 3, and have been designed to guard against extreme variations in design parameters (for example, material properties and loads) that could occur during service.

The general procedure for the partial factor method is illustrated in Figure F.1. The partial factor method uses a set of discrete inputs based upon characteristic or nominal values of loading, material or geometric properties together with their associated partial factors. The output from a deterministic partial factor analysis identifies the margin by which a limit state is satisfied (or failed).

In order to ensure that the calculations are simple for routine use, the format and values of the partial factors have been chosen to cater for a wide range of structure and component types, and failure modes. As a result, the theoretical probability of failure of structures is not equal in all cases.

Level 1 to 3 assessments, as described in Section 2, are based on implicit levels of structural safety, incorporated in the characteristic values of loads and resistance parameters and the corresponding partial safety factors. The values of the partial factors in this document for assessment of existing structures are generally intended to provide the same level of reliability as for the design of new structures.

Figure F.1 Illustration of the partial factor method for assessment

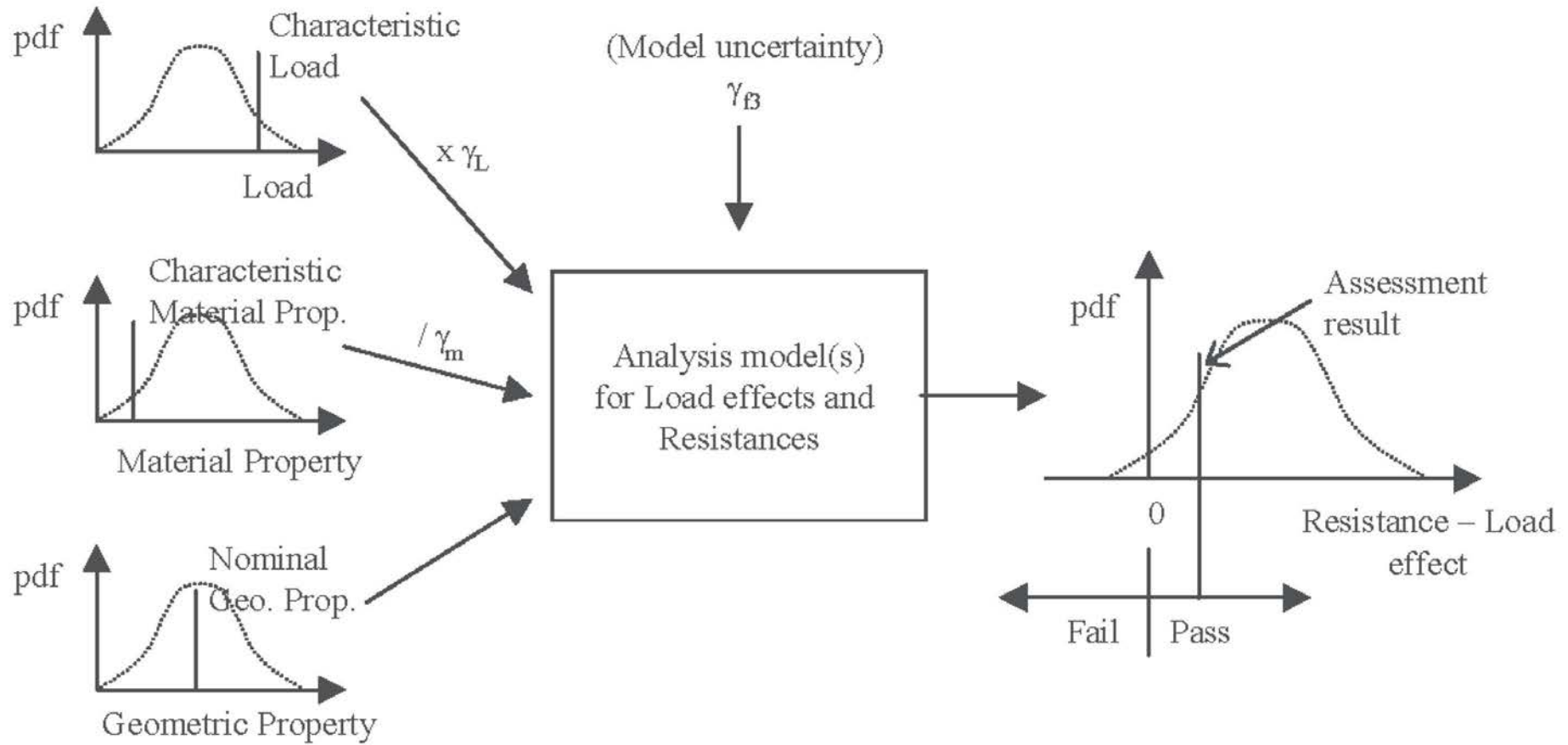

## F1.2 Reliability-based methods

This document does not cover the use of reliability-based methods of assessment.

Reliability-based methods can allow a direct assessment of whether the probability of failure of a structure is acceptably low. Reliability-based methods can be of benefit in cases where, for a specific structure or element of a structure, the use of the standard partial factors lead to a particularly conservative probability of failure, compared with that required of similar structures or elements.

The general procedures for reliability analysis is illustrated in Figure F.2. In a reliability analysis, the input parameters can be described using probability density functions (pdfs) and the output can provide a probabilistic assessment of the likelihood that the structure will satisfy a certain limit state.

The models used for analysing the effects of loads and assessing resistances, to establish whether a limit state is reached, are generally the same for both deterministic and reliability-based methods.

For example, in one method for undertaking a reliability analysis, called the Monte-Carlo method, many separate analyses are undertaken sampling input parameters from each input distribution in proportion to their likelihood. For each sampled set of inputs an analysis is undertaken in much the same manner as a deterministic analysis, with the output probability distribution constructed from the results of these many separate analyses. Because of the added numerical complexity of reliability-based methods, in some cases in a reliability analysis it can be impractical to use some of the more sophisticated analysis methods suitable for deterministic assessments.

Further information on reliability-based methods is provided in ISO 2394 [Ref 14.I] and BS EN 1990 [Ref 12.I].

Alternative approaches to a reliability-based assessment based on the use of reduced partial factors for assessment that are consistent with a reduced target reliability index are described in [Ref 23.I] and fib bulletin 80 [Ref 5.I].

Figure F.2 Illustration of reliability-based methods of assessment

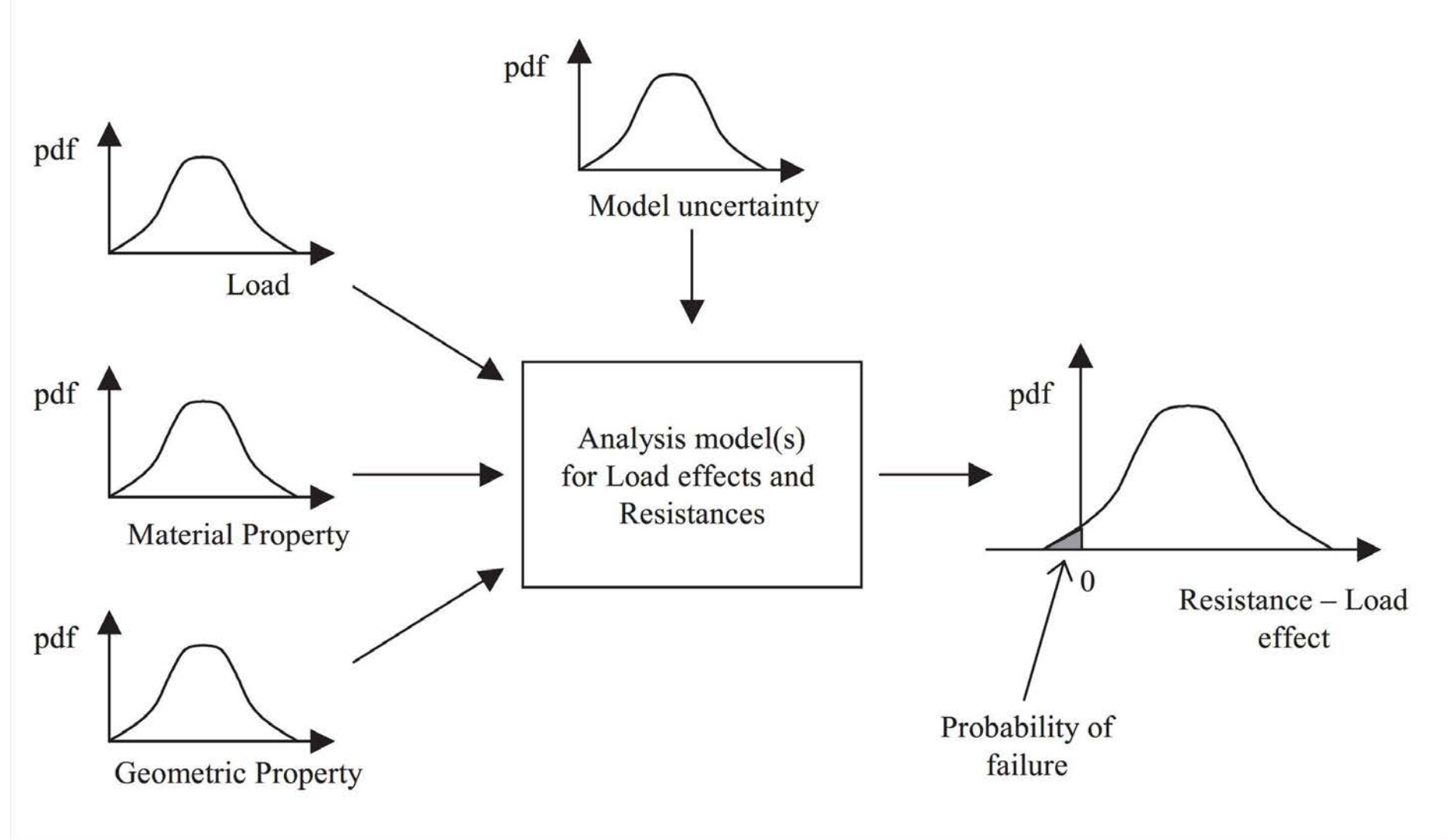

## **F2 Proposals to use reliability-based methods of assessment**

### **F2.1 General procedure**

As an extension to partial factor based assessments using the assessment levels 1 to 3 defined in Section 2, reliability-based methods of assessment can be proposed to the Overseeing Organisations as a method for further assessment.

Reliability-based assessments require specialist knowledge and expertise and are only likely to be accepted in exceptional cases.

If reliability-based assessments are proposed, the Overseeing Organisations should be consulted to approve the details of the methods and criteria to be used, and the category of checking.

### **F2.2 Methods and criteria**

The proposed approach for any reliability-based method of assessment should include the definition of the following:

- 1) target reliability index for assessment;
- 2) reference period for the reliability index;
- 3) maximum annual probability of fatality due to structural failure;
- 4) maximum annual probability of structural failure;
- 5) distribution functions defining all input variables, including distribution type, mean and coefficient of variation;
- 6) details for the approach to be used for assessment verifications.

Where reduced partial factors are proposed, the values of all of the partial factors should be defined and agreed.

The justification for the proposed target reliability index and other criteria should include a description of how the following have been quantified and included:

- 1) consequences of failure;
- 2) costs of safety measures;
- 3) the form of the critical failure mechanism and the likelihood of damage being observable prior to failure;
- 4) the service life of the structure;
- 5) the relationship between the probability of structural failure and the probability of fatality;
- 6) the basis for the distribution functions for input variables;
- 7) methods for updating the distributions of parameters based on information and measurements from the structure (where proposed).

© Crown copyright 2019.

You may re-use this information (not including logos) free of charge in any format or medium, under the terms of the Open Government Licence. To view this licence:

visit [www.nationalarchives.gov.uk/doc/open-government-licence/](http://www.nationalarchives.gov.uk/doc/open-government-licence/),  
write to the **Information Policy Team, The National Archives, Kew, London TW9 4DU**,  
or email [psi@nationalarchives.gsi.gov.uk](mailto:psi@nationalarchives.gsi.gov.uk).