

CINTEC

INTERNATIONAL

DESIGNED ANCHOR SYSTEMS

Structural repair solutions
for stabilisation & conservation



THE QUEEN'S AWARDS
FOR ENTERPRISE
2002



Copyright ©

Cintec Reinforcement Systems

CINTEC

**Structural Repair,
Stabilisation &
Conservation System**

INTRODUCTION

The Cintec Anchor System is a versatile method of structural reinforcement tailored to meet the specific strengthening and repair requirements of individual projects. From historical buildings and monuments, to bridges, high-rise blocks and harbour walls, Cintec has a worldwide reputation for resolving the technical challenges of structural preservation, whilst remaining sensitive to the original architecture.

In brief, Cintec Anchors have the following advantages:

- Easily fixed even in weak substrates.
- Effective in poor quality materials and for bridging cavities.
- Sympathetic with existing structures – cementitious based.
- Versatile in its application.
- Custom designed for different applications.
- Permanent fixing.
- Quickly installed.
- Capable of rapid manufacture.
- Invisible when installed.
- Resistant to fire.
- Approved by heritage organisations worldwide.

The Cintec Reinforcement system comprises a steel bar (or multi-bar) enclosed in a mesh fabric sleeve into which a specially developed grout is injected under low pressure. The grout is a Portland cement based product, containing graded aggregates and other constituents which, when mixed with water, produce a pumpable cementitious grout that exhibits good strength without shrinkage. Installation is via precisely drilled holes using wet or dry diamond coring technology. The flexible sleeve of woven polyester restrains the grout flow and expands to up to twice its previous diameter, moulding itself into the shapes and spaces with the walls. This provides a mechanical bond along the entire length of the anchor without the need for unsightly patress plates on the exterior of the structure.

The size and type of steel anchor, the strength of grout and the diameter of the hole can all be varied to provide an appropriate stiffness compatibility with the masonry. The bond strength between the grout and the masonry are usually derived from static pull out tests.



This brochure is intended to give a basic guide to the Cintec designed anchor system and is not intended to be fully comprehensive. Cintec International Ltd, on behalf of its employees, servants or agents exclude any or all liability whatsoever arising directly or indirectly from the use of the Cintec Anchor system in so far as the exclusion of the same is permitted by common law and statute.

Copyright © Cintec 2012 All rights reserved. No part of this brochure may be reproduced or transmitted in any form or by any means, electronic or mechanical, including photocopying, recording or any information storage or retrieval system without prior permission from Cintec International Limited.



DESIGN CONCEPTS

The Grout

Presstec is a cementitious grout, a factory produced mix, with graded aggregates and other constituents which, when mixed with water, produce a pumpable grout that exhibits good strength with no shrinkage.

Presstec is made in accordance with the following German DIN standards:

DIN EN 197-1	DIN EN 196
DIN 4226	DIN EN 932
DIN EN 933	DIN EN 1097
DIN EN 1367	DIN 18555
DIN 18557	

The grout is independently checked both during manufacture and before final despatch. This control is undertaken by the material testing institute of the German Federal State of Northern Rhine-Westphalia MPA NRW. Proof of the inspection is marked on every bag with the control mark 'U' or 'Überwach Controlled'.



Typical values of the grout are:-
MEAN TENSION N/mm²

PRESSTEC STANDARD	PRESSTEC 2000
@ 3 days = 2.5	@ 24 hrs = 3
@ 7 days = 3.5	@ 7 days = 5
@ 28 days = 4.5	@ 28 days = 9

MEAN COMPRESSION N/mm²

PRESSTEC STANDARD	PRESSTEC 2000
@ 3 days = 21.2	@ 24 hrs = 40
@ 7 days = 37.2	@ 7 days = 54
@ 28 days = 51.5	@ 28 days = 65

The grout has inorganic flow and anti-shrink additives which meet the requirements of German DIN standards. The grout has also been tested using accelerated shrinkage tests and found to be satisfactory. The grout bonds to the parent material through the sock as it is inflated.

The resistance strength of the insitu construction to resist the anchor load depends on the section utilised. If the section is solid bar, the anchor body is deformed. If the anchor is circular, the section is crimped. On square section material, a plate almost the size of the borehole is welded to the anchor at both ends to ensure the strength is mobilised.

The Sock

The fabric sleeve is specially woven polyester based tubular sock with expansion properties to suit the diameter of the bore hole and substrate. The mesh of the sock is designed to contain the aggregates of mixed grout while still allowing the cement enriched water (milk) to pass through the sock both sizing and bonding to the substrate. The sock is manufactured in sizes from 20mm to 300mm in diameter and is adjusted to suit each individual application.

The Reinforcing Member

The types of reinforcing members utilised depend largely on the loads anticipated and the life expectancy of the anchor.

The Parent Material

The strength of the parent material and/or mortar can govern the anchor capacity. Design checks on the parent material capacity can be based on the resistance strength of the insitu construction to the anchor force according to the national standards. When the parent material or mortar strength is indeterminate, the capacity of the material/mortar can be determined from insitu anchor tests.

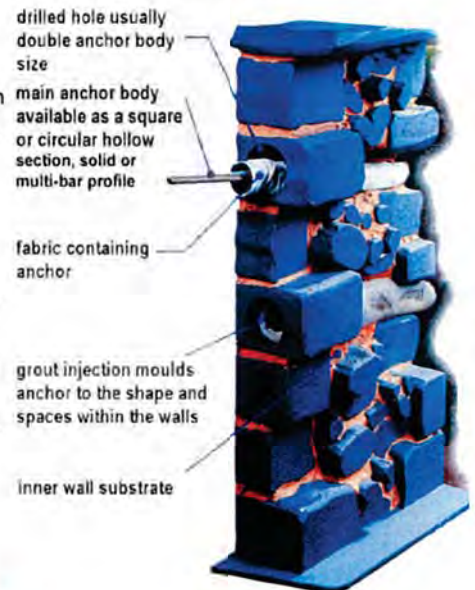

See table below for a few examples:

Steel Sizes	Steel Sizes	Standard	Grade 304	Grade 316	Class	0.2% Proof Stress N/mm ²	Ultimate Tensile Strength
8mm x 0.75mm	Circular Hollow Section	BS 6323	304 S11			185*	480*
10mm x 1mm	Circular Hollow Section	BS 6323	304 S11			185*	480*
15mm x 15 1.5mm	Square Hollow Section	ASTM A554	AISO 304	AISO 316		210*	510*
20 x 20 x 1.5mm	Square Hollow Section	ASTM A554	AISO 304	AISO 316		210*	510*
30 x 30 3mm	Square Hollow Section	ASTM A554	AISO 304	AISO 316		210*	510*
13.7mm x 2.24mm	Circular Hollow Section	ASTM A312	AISI 304	AISI 316		210*	510*
17.1mm x 2.31mm	Circular Hollow Section	ASTM A312	AISI 304	AISI 316		210*	510*
21.31mm x 3.73mm	Circular Hollow Section	ASTM A312	AISI 304	AISI 316		210*	510*
6mm to 40mm	Deformed Bar	BS 6744	304 S11	316 S33	250	250	460
					460	550	650
					800	650	800
M3 to M40	Allthread Studding	BS 6105	A2	A4	50	210	500
					70	450	700
					80	600	800
GB 12 to GB48	Grip Bar	BS 6744	304 S31	361 S31		650	750

The grade 316 contains Molybdenum, which improves the resistance to corrosion and is beneficial especially in chemically aggressive

environments. Higher grades of stainless steel are available for specialist applications.

* For guidance only. Figures are based on steel before forming and welding

DESIGN PARAMETERS

A. Cone of Resistance - illustrated

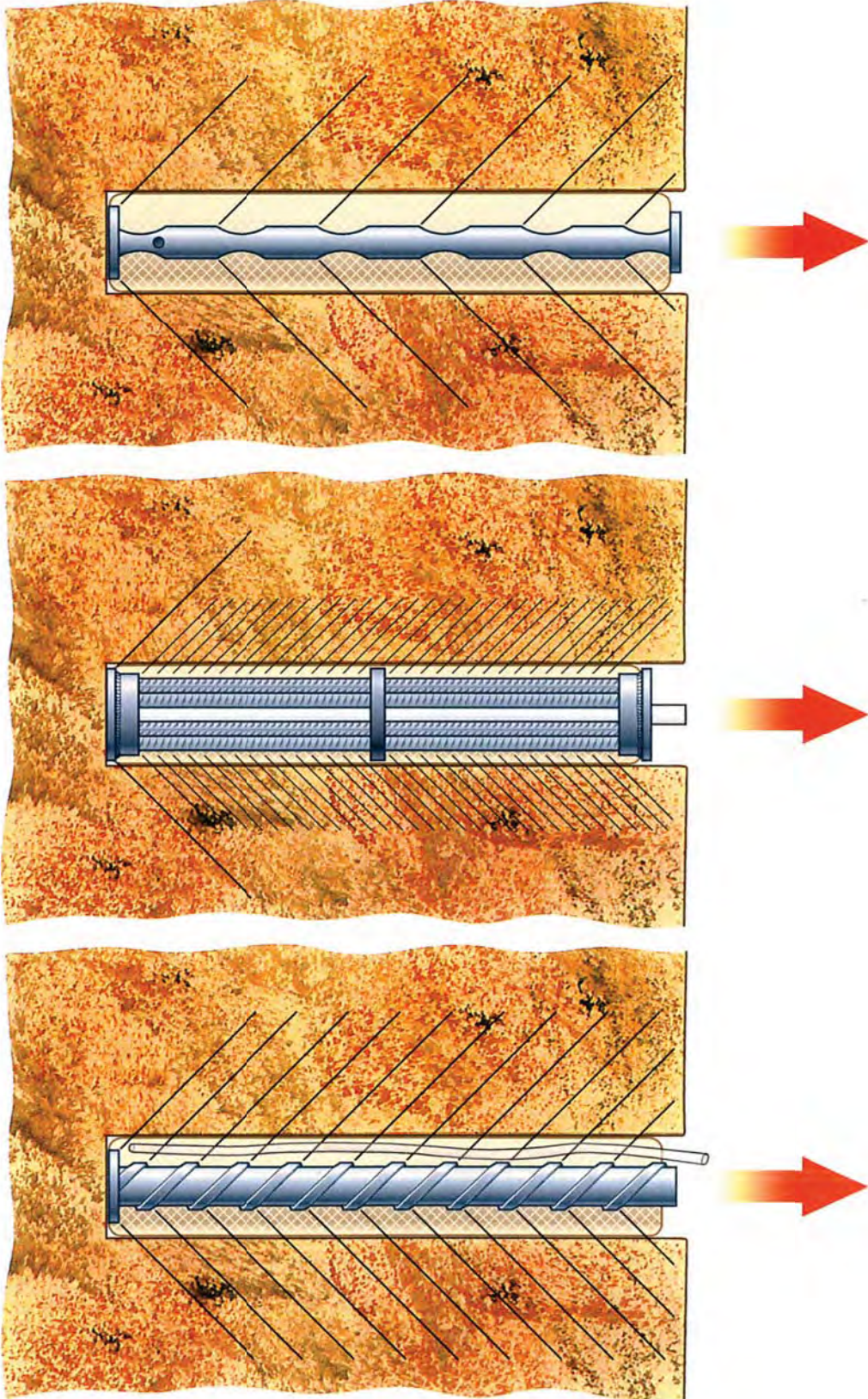

ANCHOR PRINCIPLE

The Principle of the Cintec anchor system is illustrated below. The stainless steel hollow section has been inserted into insitu materials in the drilled holes on either side of the cavity. The grout has been injected under pressure, inflating the sock throughout, but noticeably in the cavity and the hollow in the outer leaf. Milk grout has passed through the expanded sock mesh to provide a chemical and mechanical bond to the insitu materials.

First, an oversized hole is drilled between the substrates to be secured.

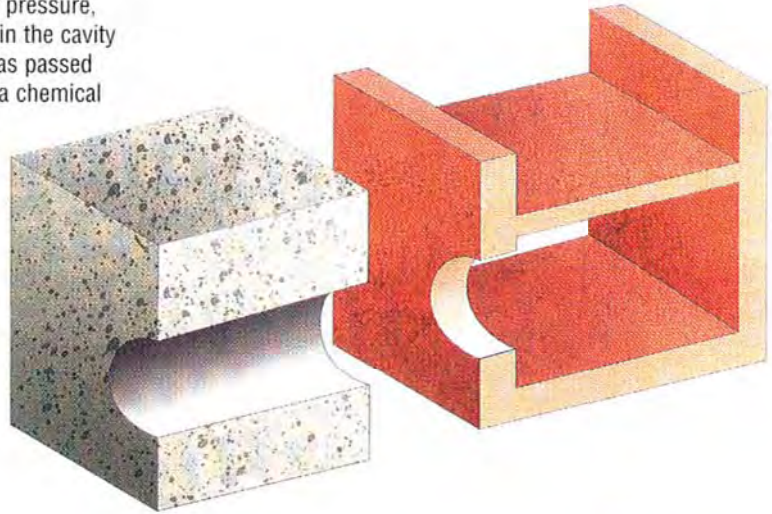

Secondly, the designed Cintec anchor is placed in the correct position.

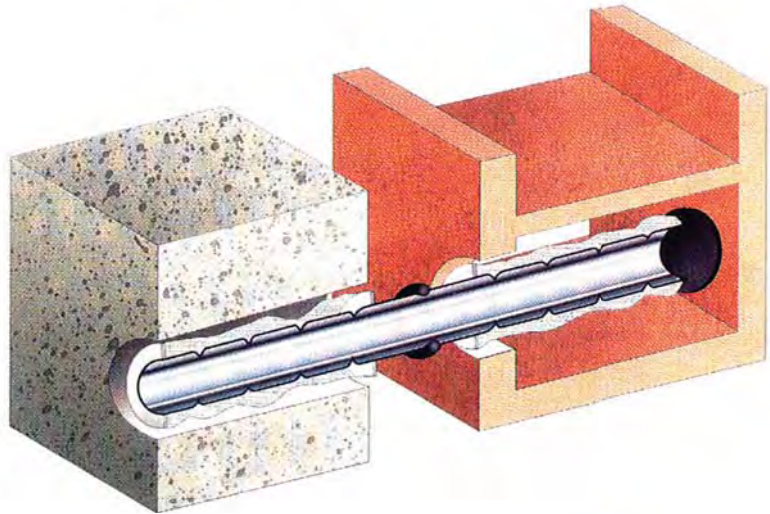

Finally, the anchor is inflated like a balloon to provide a permanent cementitious anchoring solution using one of Cintec's range of sympathetic grouts.

Presstec grout pumped under pressure through the anchor body into the fabric sock.

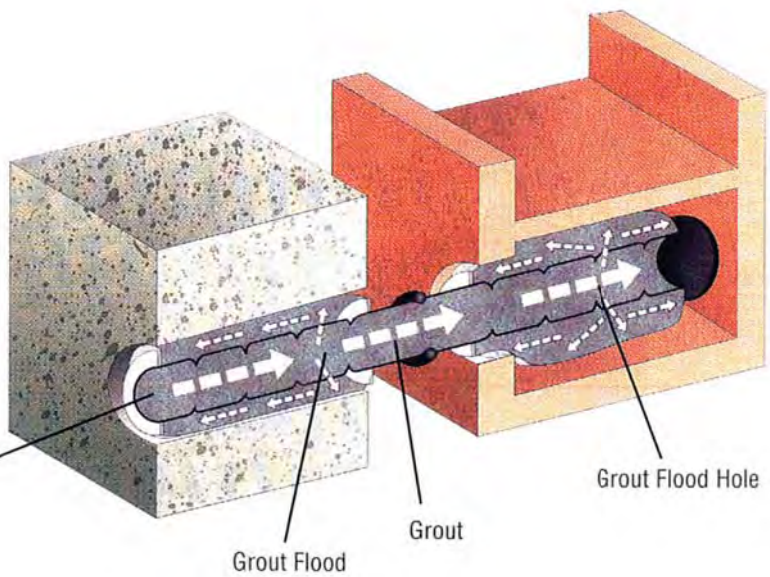

GROUTING EQUIPMENT AND PRINCIPLES

A pressure pot capable of being pressurised to 2-4 bar

The outlet on the pressure pot needs to be altered to accept a 1/2" bep hose adapter with 4 Mts. of reinforced 1/2" tubing and a 1/2" quarter turn ball valve. A 1/2" hose adapter or threaded attachment needs to be screwed into the valve to enable plastic mastic nozzles to be pushed or threaded onto the front of the valve. This assembly will then serve as the grout delivery hose and control valve.

- 6 c.f.m compressor (minimum).
- Mixing paddle or whisk.
- Electrical drill for mixing.
- Two large mixing buckets 18 lt. min.).
- Measuring jug in litre increments.
- A large flour sieve.
- Power generator or 110v transformer.
- An adequate supply of mastic nozzles to suit control valve on delivery hose.
- Safety goggles and gloves.

All equipment must be kept in a clean condition. Do not use oil or releasing sprays inside the pressure pot as this may contaminate the grout.

Safety goggles and gloves must be worn at all times when mixing and injecting grout.

GROUT MIXING

The grout is packed in 25 kg bags and is mixed with clean cold water. The normal mixing ratio is 5 1/2 ltrs of water to one 25 kg bag of grout. One 25 kg bag will yield 16 ltrs of fluid grout when mixed.

The 5 1/2 ltrs of water can be increased by 10% (500mL) in hot weather (20°C+) and when the substrate is very dry or porous or the injection process is through very small injection tubes.

Do not increase the water content outside these parameters as this will considerably weaken the strength of the set grout.

The grout must be mixed as follows:-

Place 5 ltrs of clean/cold water into a clean mixing bucket and slowly add approx. 3/4 of one bag of Presstec grout while mixing.

Add a further 1/2 ltr of water (to make up the required 5 1/2 ltrs) and the remaining grout.

Continually mix the grout for 4 minutes removing all the dry mixture from the sides of the bucket.

Allow to stand for 5 minutes, during which the mixture will start to thicken, the amount the mixture thickens will depend on the ambient temperature and the temperature of the dry grout and water.

At this stage some or all of the 10% extra water may be added to achieve a smooth creamy texture with no peaks forming on the surface.

Pour the mixed grout into the pressure pot through the sieve.

Pressurise the pot from 2 bar to 4 bar dependent on the type and length of anchor being installed.

Cut the plastic mastic nozzle to fit the anchors orifice. On anchors with injection tubes, prime the tube with water and cut the mastic nozzle to fit over the injection tube.

Test the grout flow into a suitable bucket. If the grout flow is continuous and of sufficient pressure the anchor can be injected.

Carefully push the nozzle into the anchors orifice or over the injection tube and position the anchor to the specified depth (minimum 25mm beyond face of brickwork).

Turn on the control valve and the grout will flow to the rear of the anchor and inflate the sock along the length of the anchor to the front.

Move the anchor in a circular motion to facilitate the front grout flow and to ensure the anchor is centred in the bore hole upon completion.

At this stage the anchor will be felt to be locking in the bore hole and a grout milk will appear at the front of the anchor (note the colour change in the sock).

Maintain the pressure until the grout milk has stopped flowing and the sock at the front of the anchor cannot be compressed.

Use a sponge or cloth during this process to soak up the excess grout milk and avoid the milk running down the face of the brickwork/stonework.

Any grout or milk on the wall must be washed off immediately.

Please note that the anchor is not fully inflated until the grout milk has stopped flowing through the sock.

Pressure must be maintained to allow this to be achieved.

With large injection orifices a suitable plug must be placed in the injection port immediately after removing the nozzle.

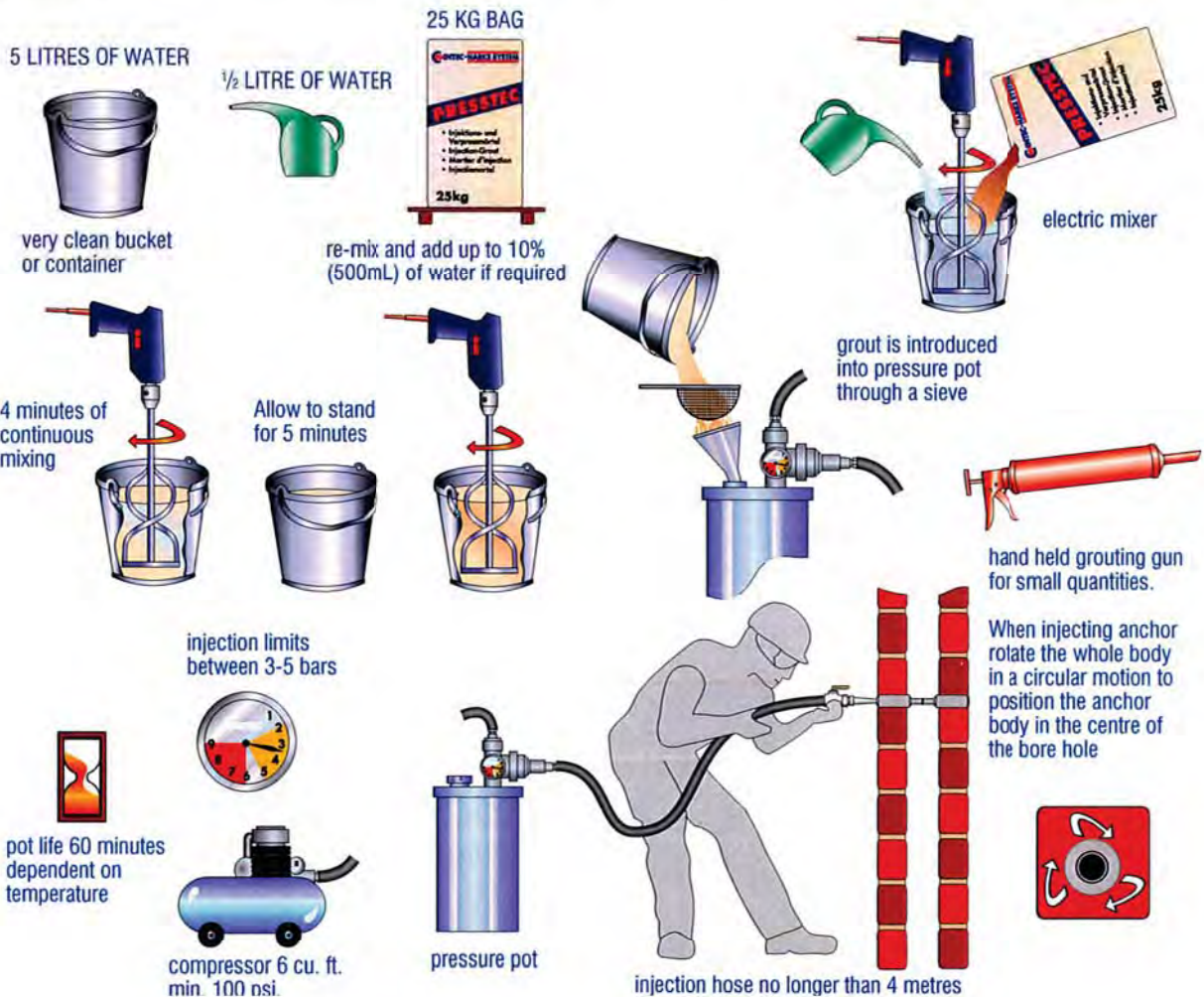

COLD WEATHER HINTS

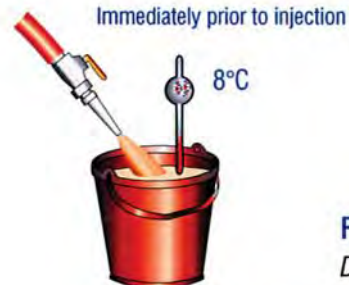
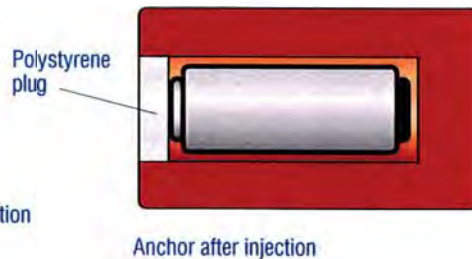
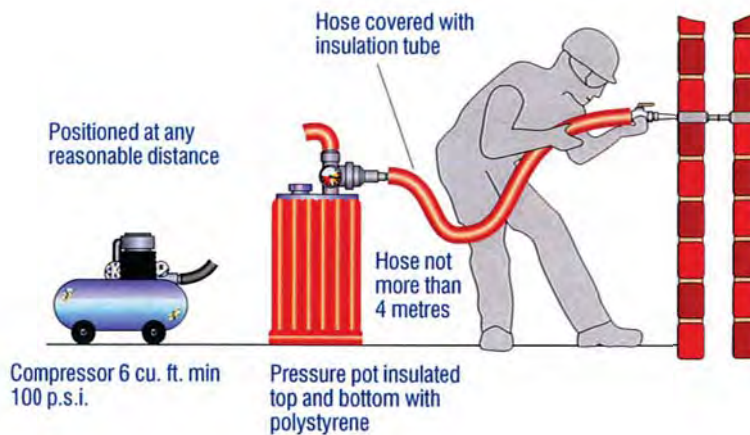
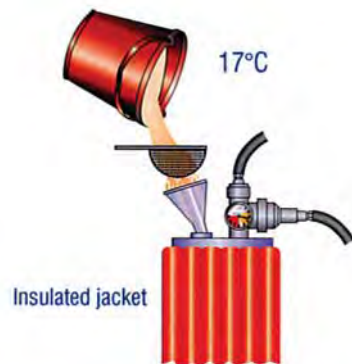
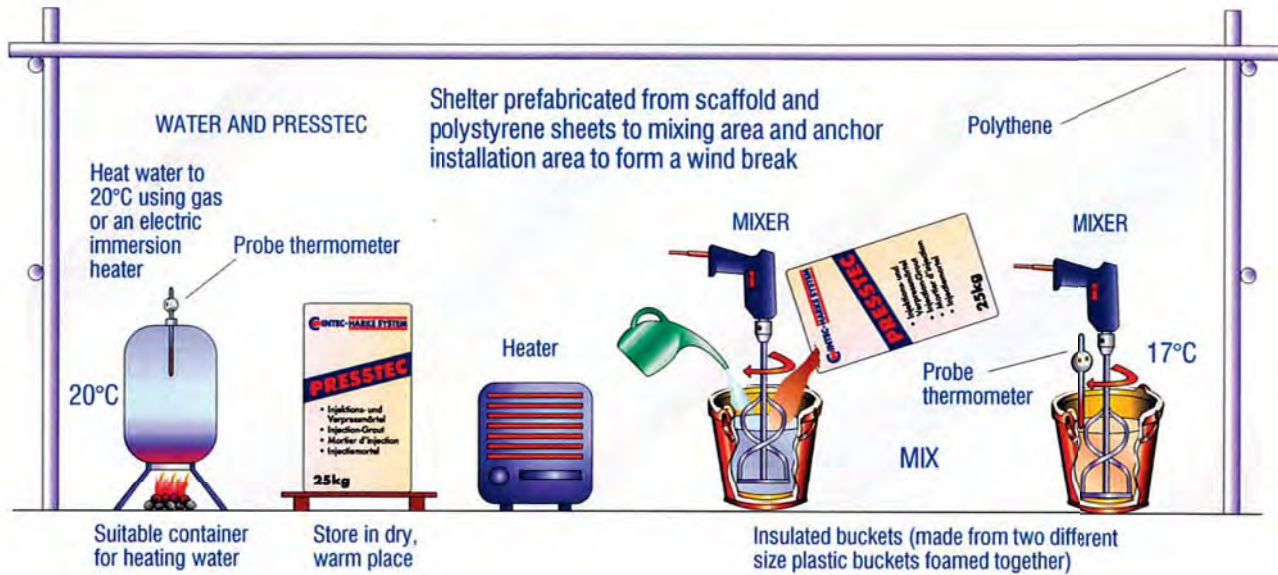

Check control of last contents of pot

INJECTION PERIOD



RECORD

- Date
- Batch number
- Water temperature
- Temperature of bore-hole prior to inflation of anchor
- Final mixing temperature
- Temperature prior to injection
- Final pot batch temperature

TRAINING CERTIFICATION

THE TRAINING COURSE

The object of the training course is to give the installer a complete knowledge of the Cintec Anchoring System. During the course the Cintec Anchoring System is demonstrated, and the installers given hands on experience as to the techniques of installation.

Upon completion of the course, successful trainee's are certificated and issued with an identity card. The company is then entered onto the Cintec approved installers list.

THE CERTIFICATION / INSTALLERS MANUAL

The certification procedure and its accompanying training manual provide a basic guide to the installation of the Cintec anchor system. Whilst it provides a firm basis for its use, it cannot comprehensively cover all possible applications. Additional information and training is available from Cintec International Ltd. subject to prior arrangement.

The requirements of the Health and Safety Act are drawn to the attention of trainee installers, particularly with regards to the use of the grout and equipment.

The use of diamond core and rotary percussive drills is presented. More detailed instructions are given in the manual about diamond core drills in hand held applications.

Grout and grout mixing are presented. This stage is the most important in the application of the Cintec Anchor System. The grout has been carefully designed and if mixed in clean equipment and according to specified procedure, successful grouting can be routine. Site and equipment cleanliness are fundamental to safety and successful installation.

Successful grout injection relies on good treatment of both anchors and grout from the moment of their arrival on site. Emphasis is placed on their careful storage and handling.

The operation of the grout pressure pot is detailed in the manual along with graphical illustrations. Emphasis is placed on the requirement for cleanliness for all aspects of the mixing and grouting. Graphical illustrations are given of the steps in the grouting procedure, together with details of the customary range of injection pressures.

The two stage mixing of the grout is detailed carefully. The specified procedure leads to a grout which is easily and successfully injected. Details are given to enable the installer to monitor the mixing procedure and subsequent injection to ensure the grout injection is successful. Details for hot and cold weather grouting are given.

Anchor injection is specifically illustrated, since this provides visual and tactile evidence of successful anchor installation. Attention is drawn to the visible excess milk grout which should be present at the front of the sock and the front of the anchor should be firm to the touch and not move in any direction. The excess grout milk is washed off immediately.

IDENTITY CARDS

An installer is required to carry his identification card on site whilst undertaking all work requiring the use of the Cintec Anchoring System. The card must be available upon request to all authorised site and Cintec International Ltd. personnel. Cintec carries the responsibility for the product whilst the installer has the responsibility to carry out the work in a professional manner.

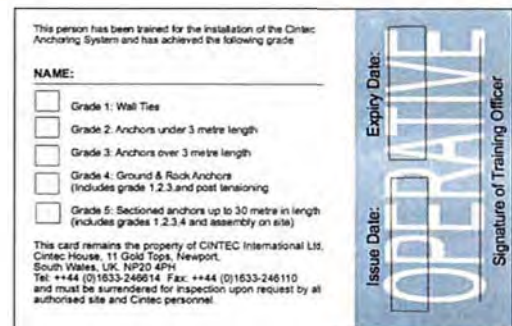
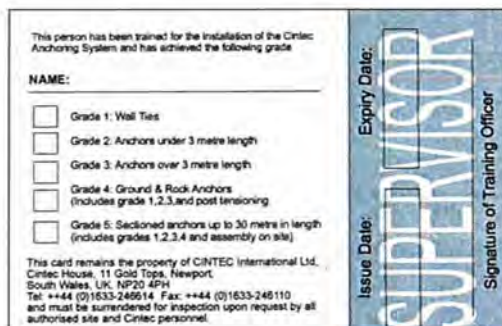
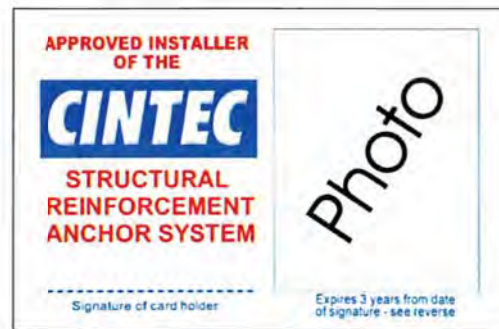

BRE TESTING

ACCELERATED MOISTURE/TEMPERATURE CYCLING: TESTS BY BUILDING RESEARCH ESTABLISHMENT

Cintec wall ties were subjected to accelerated moisture/temperature cycling to model the insitu conditions of the ties in traditional cavity construction. The tested wall tie was a standard 8mm diameter x 1mm CHS stainless steel section in a nominal 16mm diameter drill hole. The tie had a conventional polyester sock and the standard PRESSTEC grout was pressure injected in the usual manner. Clay facing bricks of 212mm x 100mm x 65mm size were used as the test parent material.

The test programme assumed that the insitu cavity construction would be fully saturated bay rain-water at least once a year. It was established by trials that a half hour soak in a water tank, followed by a minimum of 2 days drying in an electric oven heated to 40°C(±2°C) to constant weight, would satisfactorily model insitu conditions.

Five pull out tests on the brick anchor specimens were undertaken seven days after construction, then at 10, 20, and 40 cycles of wetting/drying of the specimens. The tests were undertaken in a Universal Testing machine, calibrated to BS1610: 1985 Grade 2. A side load of 3.5N/mm² pressure was applied to the bed faces to simulate conditions of confinement of the brick insitu.

The full saturation value after 24 hour immersion of the brick in water was 17.5% compared to a water absorption of 15% achieved after the test soak period of 30 minutes. The nominal brick compressive strength was 43.3N/mm². The test pull out values were as follows:

Specimen No.	After 7 days cure	After 40 wetting/drying cycles
1	10.45	9.10
2	12.23	11.00
3	10.68	10.00
4	10.45	12.90
5	10.90	9.79
Mean	10.94	10.56
Coefficient of Variation%	7.00	14.00

A one way analysis of variance showed the affect on the pull out performance was not significant. Regression analysis (linear as well as polynomial) confirmed this lack of significance.

The general conclusions were:

1. The pull-out performance of the test/anchor clay brick combination would not be adversely affected in any significant manner in conditions of exposure to rain simulated in the test.
2. Failure of the specimens was typically by pull-out of the steel tube, the steel strength primarily governed the capacity of the anchor.
3. Pull-out performance of the anchor/brick system appeared to be directly proportional to the length of embedment.

The full report is available on request.

CIVITEC

Anchor Technical Information

Copyright ©

Please do not participate or encourage piracy of copyrighted material in violation of Cintec's rights.

PATENTS

Since 1965 Cintec has strived to become the world leader in the design and manufacture of project specific designed cementitious anchoring and reinforcement systems. **PATENTS** have been obtained worldwide and additional patents have been applied for and are pending. A partial list of Patents / Patents pending includes, but is not limited to: 2245121, 2764006, 0090895, 5216857, 116188, 1210495, DE19609914, 3608775, DE2315859.



GLOSSARY OF TERMS USED IN THIS BROCHURE

CHS	- Circular Hollow Section
DRB	- Deformed Ribbed Bar
JAR	- Joint Remedial Anchor
RAC	- Remedial Anchor Cavity
RAD	- Remedial Anchor Large Diameter
RWT	- Rigid Wall Tie
SHS	- Square Hollow Section
ST	- Stud
WSA	- Wall Supporting Anchor

CINTEC V

**DESIGNED CEMENTITIOUS GROUTED SOCKED ANCHORS
AND REINFORCEMENT SYSTEMS FOR THE PROFESSIONS.**

Patent Pending PCT/GB2010/050603

For more than twenty-five years Cintec products are synonymous with the concept of problem solving, manufacturing and designing of socked anchors and reinforcement systems for professionals in the construction industry.

Our experienced technical staff and consultants are able to give the appropriate guidance on the type of intervention and finally we will also provide a list of trained and approved installers to carryout the work if required.



End elevation of Stoneleigh Abbey with the typical signs of differential movement due to foundation problems. A large crack is seen at the top right hand side of the gable wall running almost vertically onto the top of the circular window. The first solution was to underpin and stabilise the foundation movement. The next step was to stitch and hold the distressed walls where there was maximum movement.

The diamond drilling rig is being prepared and secured to the scaffolding prior to drilling for the anchors at foundation level.



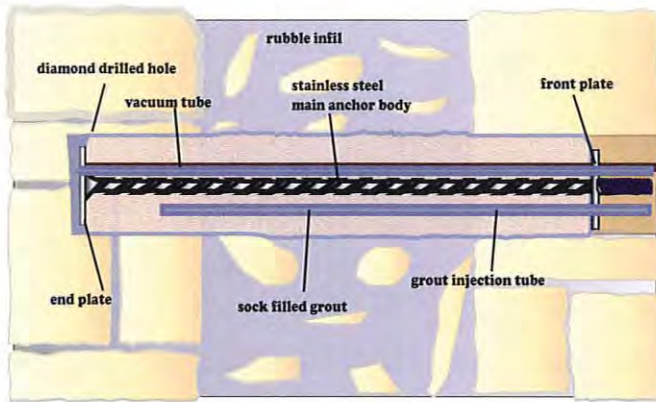

Section through wall

Typical wall consolidation



Work in progress showing the anchors positioned and inflated prior to making good and cleaning



The simple expedient of putting a fabric sock around a steel anchor body appears on the surface to be relatively easy. However, our research and experience over many years has shown that the issues involved are very complex. Consider that the operative can only see the front portion of the anchor assembly when the assembly is positioned in the drill hole and is working blind and has to judge when the whole anchor assembly is fully inflated.

The fabric outer sock that surrounds the stainless steel anchor body must be strong enough to withstand mechanical handling damage both during manufacture, storage and handling of the assembly on site during installation. Yet, the fabric sock must be thin enough to conform to the shape and profile of the drilled hole when whole assembly is installed in the drilled hole.

The fabric should not be elastic, but be semi rigid so to allow the excess grout milk to flow through the mesh in a controlled manner.

The mesh size on maximum expansion of the sock should freely allow the grout milk to passing through the expanded mesh but retain the sand particles in the main body of the anchor. The knitting configuration has been developed over many years.

The sock size has been designed to expand when inflated to fit a range of drilled hole sizes, each size has a calculated expansion to just the right size for correct installation.

If the sock is too large it will impede grout flow through the sock into the parent material and the bond between anchor and parent material will be at a minimum.

If the sock is too small in diameter, it will not be in contact with the parent material through the entire length of the hole but will be in contact only in one small place creating a tapered effect on both ends of the anchors much like a banana shape. The Cintec fabric sock is designed to expand to its full diameter without reducing its length longitudinally thus allowing total filling of the assembly.

Front elevation show how the sock after grout has been pumped along the whole length of the anchor and bridging the gap caused by the differential movement

Water is the vehicle to transport the grout into the anchor assembly. After mixing the grout in the prescribed manner, it is introduced into pressure pot and is then ready to be injected into the anchor assembly.

It is desirable to restrict the use of water to a minimum, particularly when used in old and ancient buildings and structures where it is not desirable to have copious free water flowing through the walls and surfaces.

Whilst, reduced water/ cement ratio is essential to preserve the building fabric, it is detrimental when injecting the grout into the assembly which is much easier with a higher water/cement ratio. To maintain the water/cement ratio to its optimum it is necessary to increase the injection pressure to inflate the anchor.

Increased injection pressures causes problems with weak and friable structures and has a side effect of producing excessive back pressures at the rear of the anchor that can prevent full filling of the anchor and also the danger of rupturing the sock and then being unable to pressurise the anchor assembly, so that the final loads cannot be successfully transferred from the parent material to the anchor body.

The injection pressure will depend on the length, diameter and inclination of the anchor assembly, the condition of the parent material, both the ambient temperatures of the outside and inside air and structure temperatures and the skill of the operative installing the anchor.

The fabric sock has a complex weave that is self supporting matrix of strands filled with air particles. As the grout is injected into the sock some of the particles are trapped and prevent perfect bond between the sock and the parent material. Increased injection pressure, traps more of the small air pockets in the sock and further reduces the grout milk transfer to the parent material.

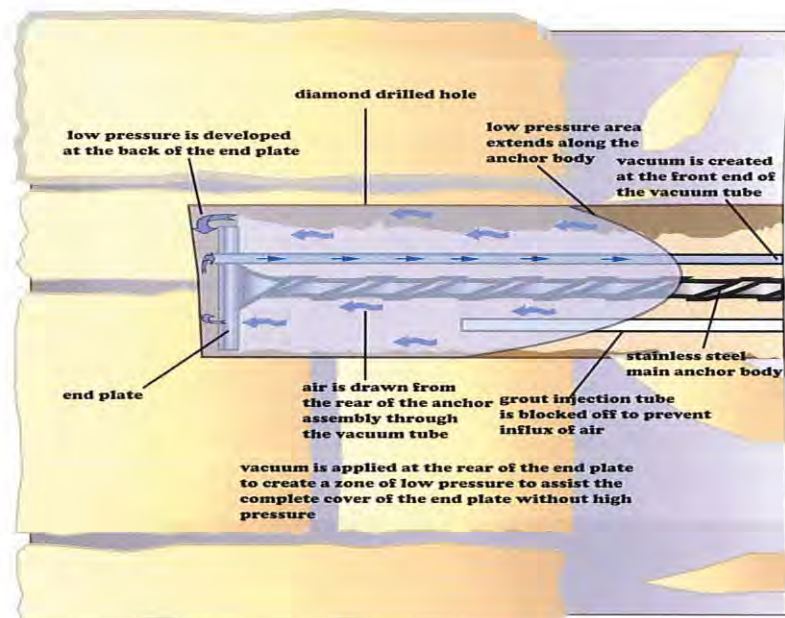

Section through wall

Cintec have examined this problem and have developed a solution to the un-necessary over pressure during the anchor inflation. Using a small secondary plastic feed tube positioned above and running parallel to the main anchor body passing through the end plate and passing through the front plate connecting to a vacuum device attached to the nozzle of the injection pump.

The vacuum device is constructed in such a way that not only will suck air from the very back of the anchor creating a vacuum or low pressure zone, but it is able to filter any grout that is carried through the vacuum tube during this process.

The vacuum or low pressure at the very end of the assembly allows the assembly to be inflated from behind the end plate when the anchor is inflated in the usual way. It prevents a build-up of back pressure, allows the grout to flow at a much reduced pressure to all the important areas surrounding the end plate without overstressing any friable or loose substrate. This is particularly important for long and inclined or overhead anchoring. It also removes most of the air pockets in the sock at the rear of the anchor with the vacuum, thus increasing the bond strength between sock and parent material. The system of creating a vacuum at any point of interest anywhere along the anchor body is another benefit for the engineer who now has the opportunity to control the flow of grout to any section of the assembly at low pressure

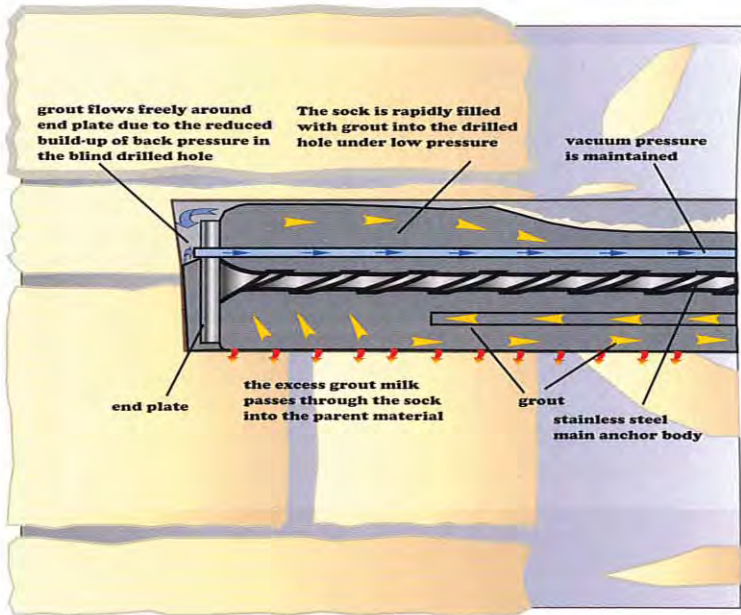

Cintec have developed a low cost vacuum system that quickly and easily fits the pressure pot and injection tubes. This allows the operative to create a vacuum and or low pressure at the end of the vacuum tube. The device is able to work continually and has a filter to prevent grout from blocking the device during use.

Section through wall



End and front elevations of Stoneleigh Abbey after all the Cintec stitching and reinforcing anchors have been installed to the external walls on four elevations. The extensive cracking was made good using matching stonework.

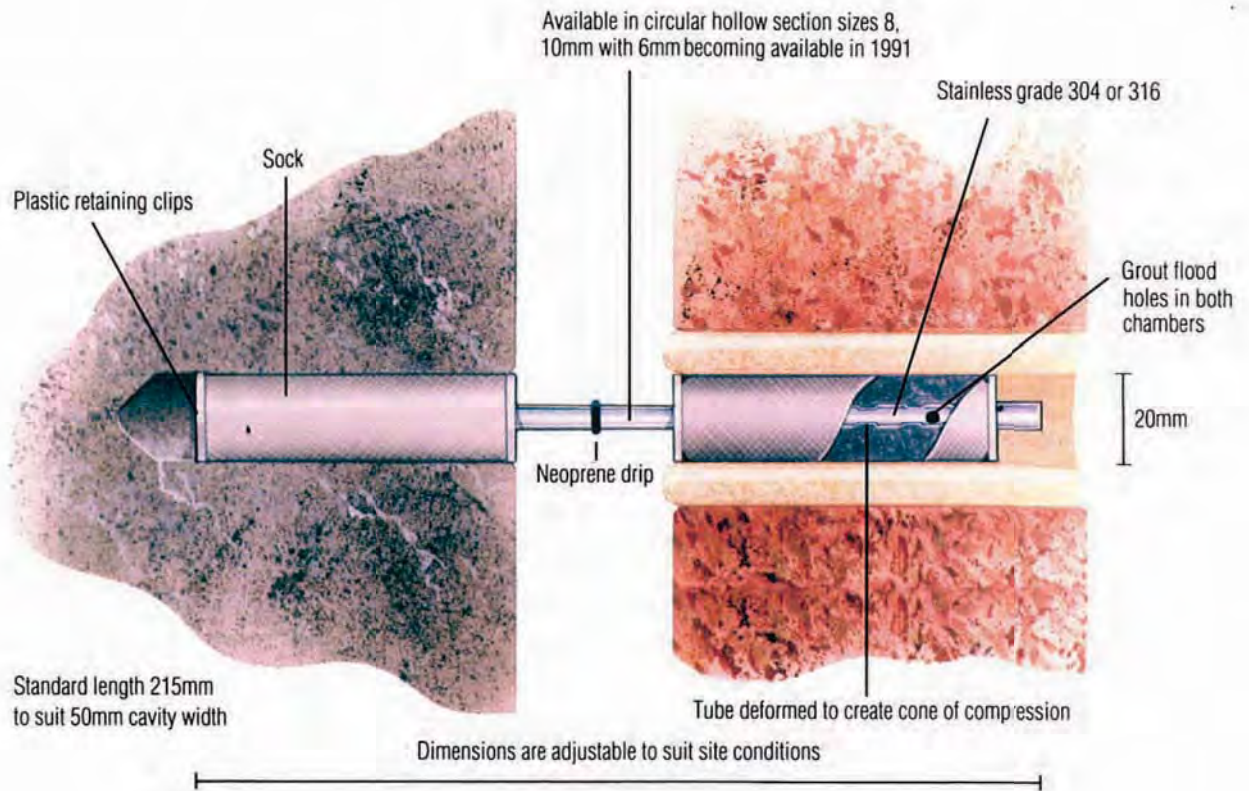

RAC for hollow pot/brick cavity wall

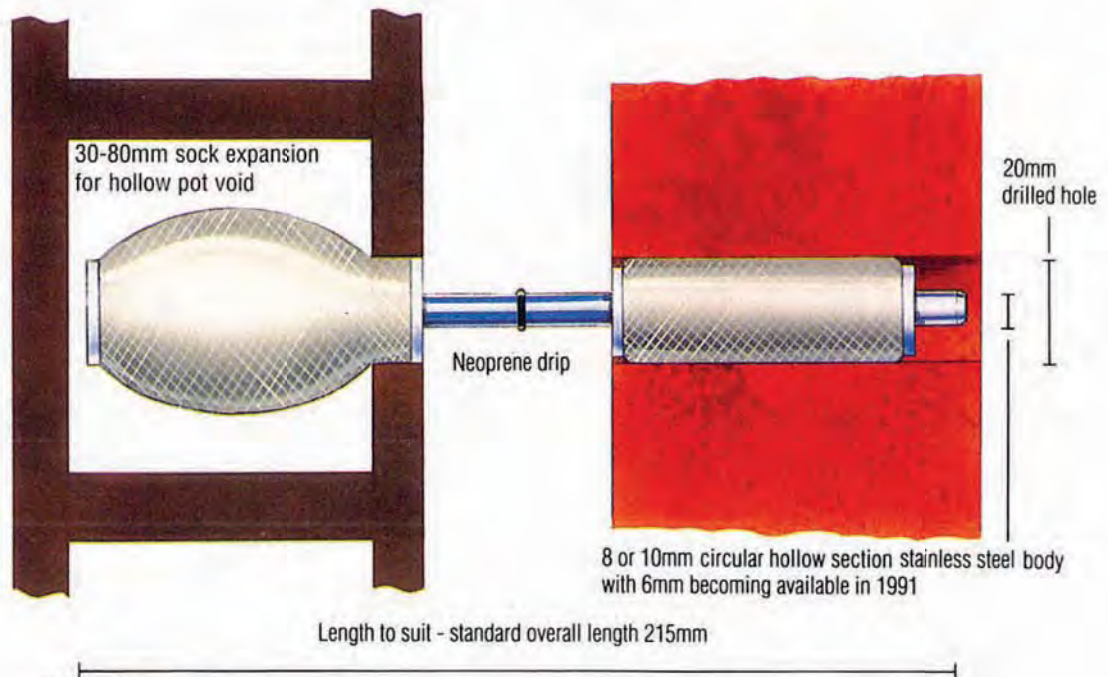

NB. Sock diameter can be varied to suit applications

Single fixing CHS 8 for single brick application

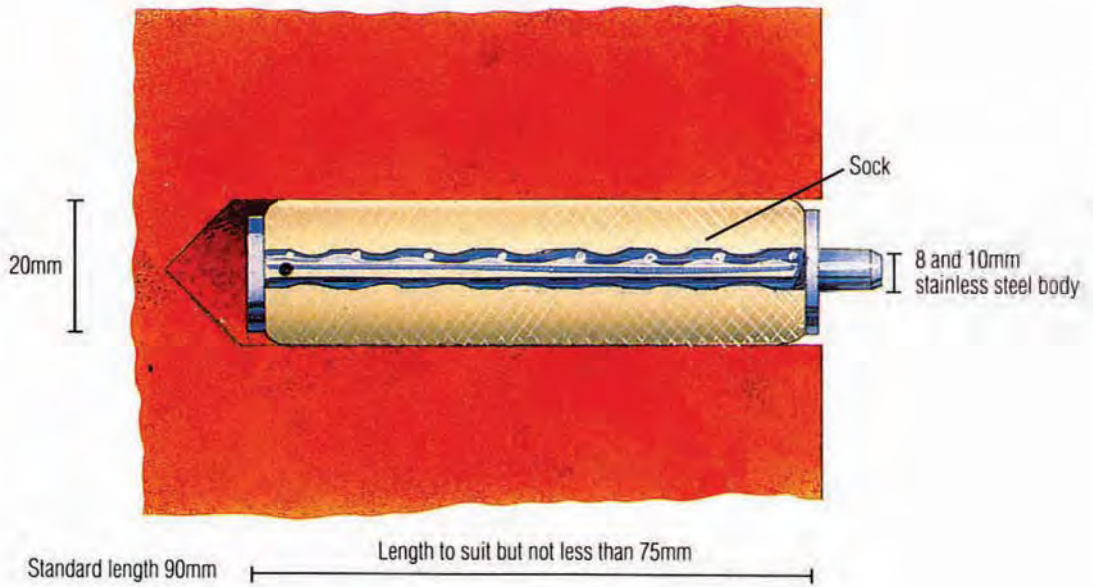

Standard outer leaf attachment for single CHS 8

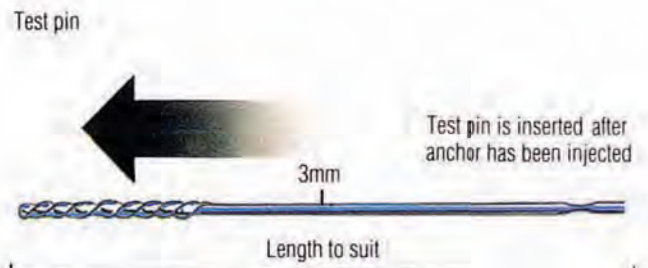
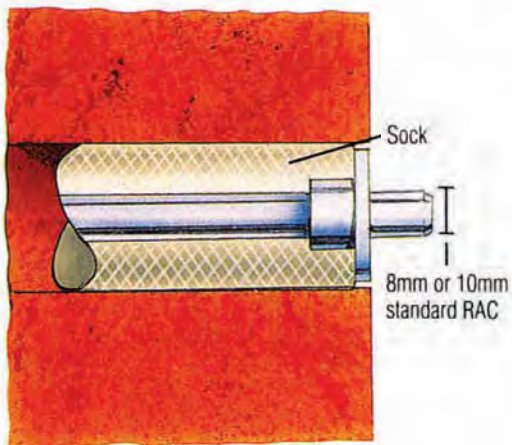
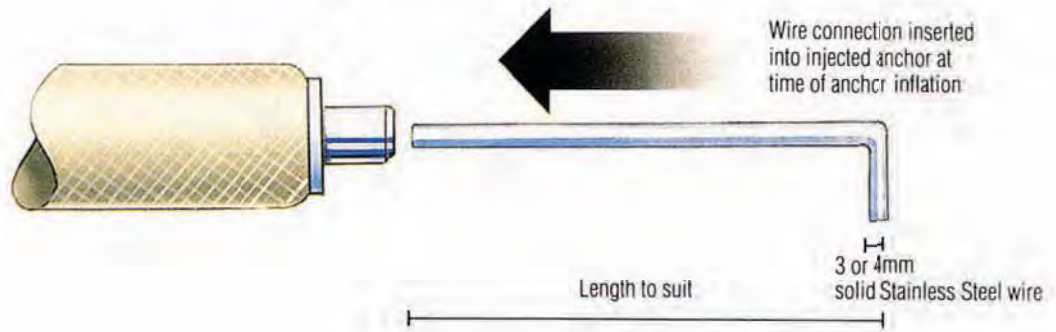

STANDARD WELDED ATTACHMENTS

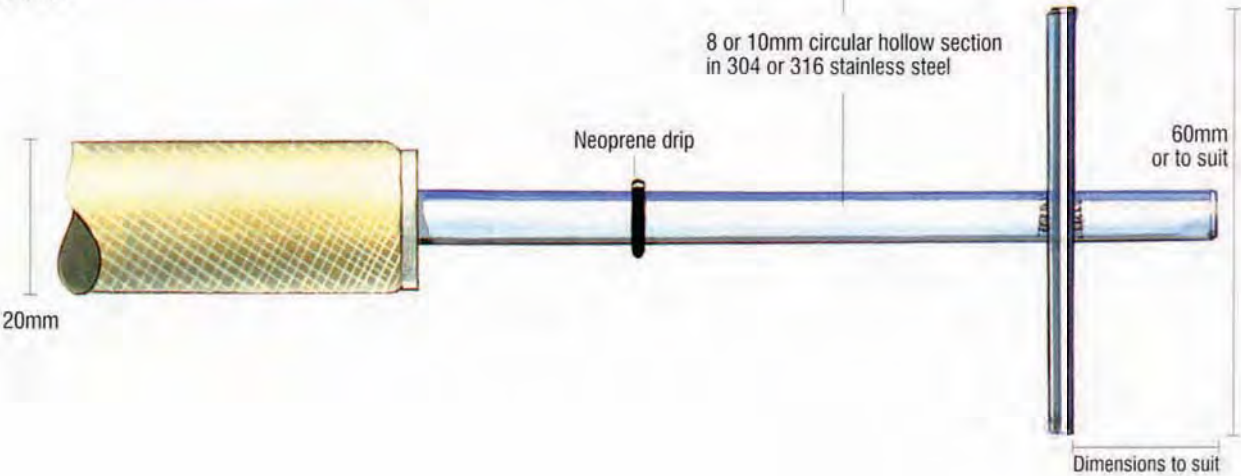
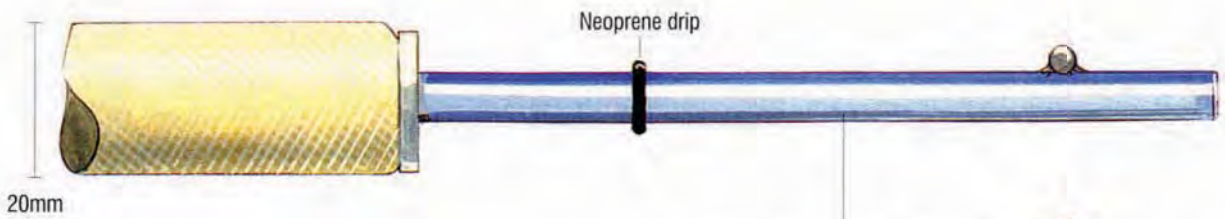
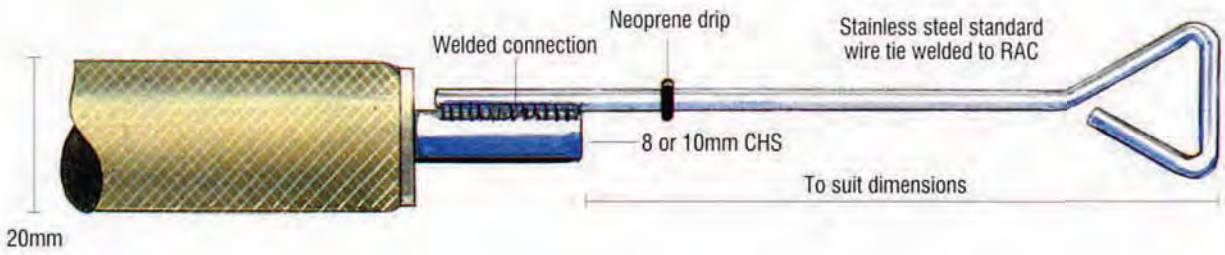
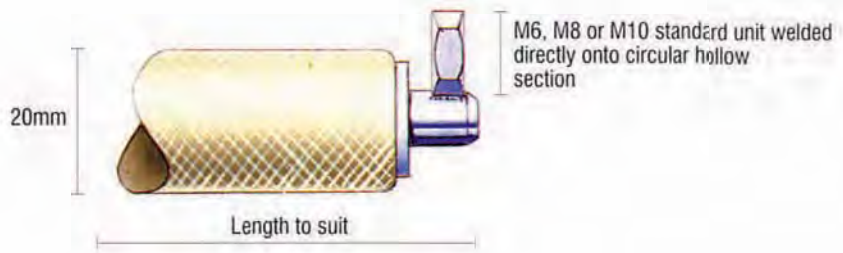

STANDARD WELDED ATTACHMENTS

Wall tie extension to support new work

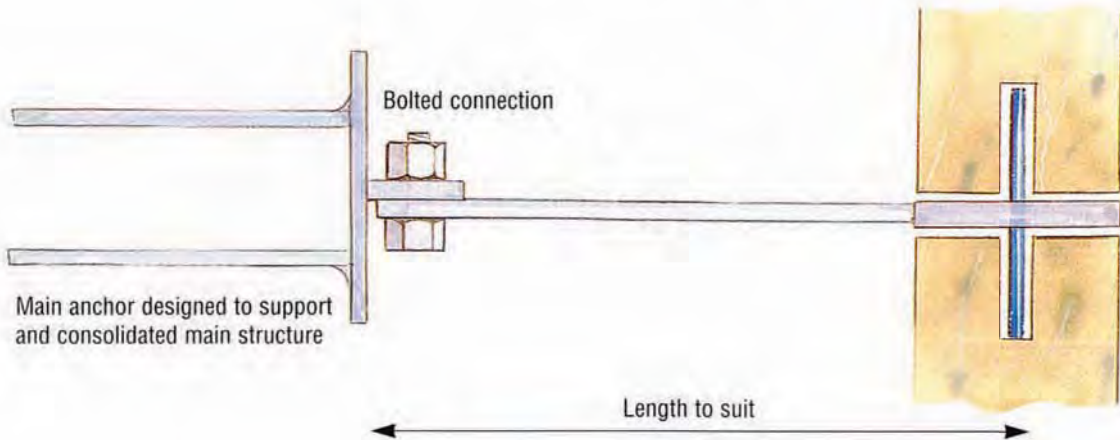
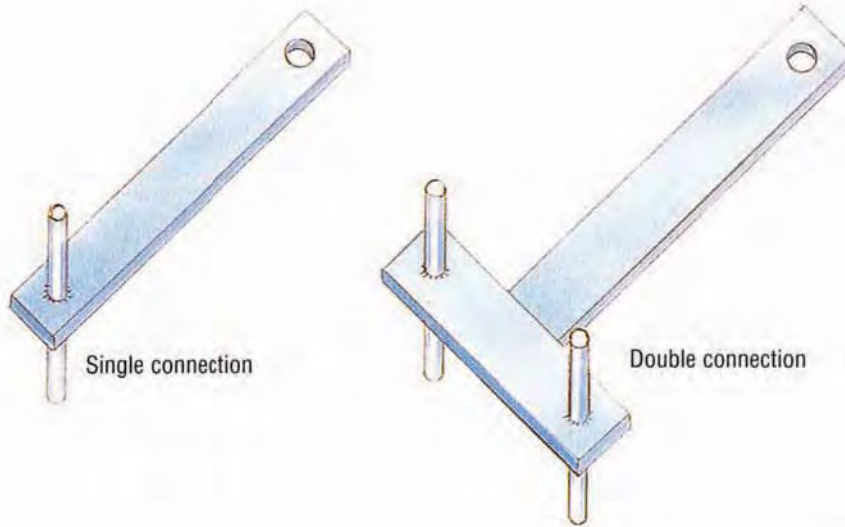
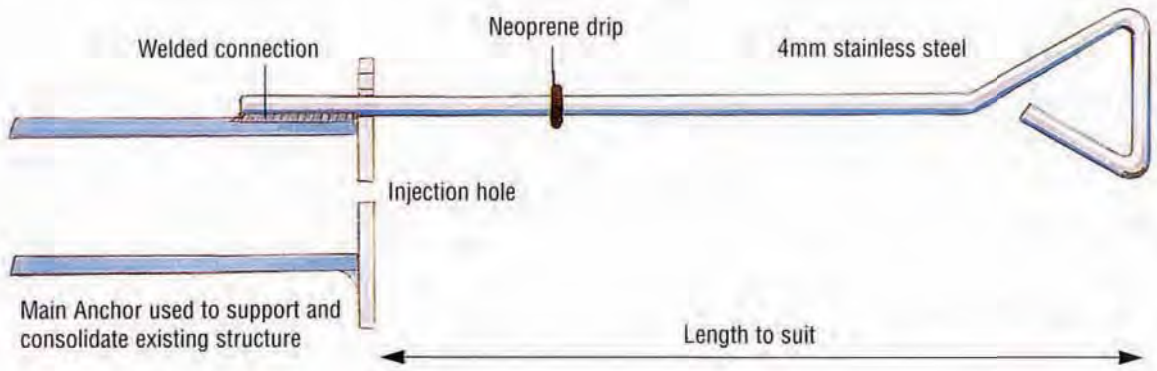

STANDARD WELDED ATTACHMENTS

TYPE RWT & WSA

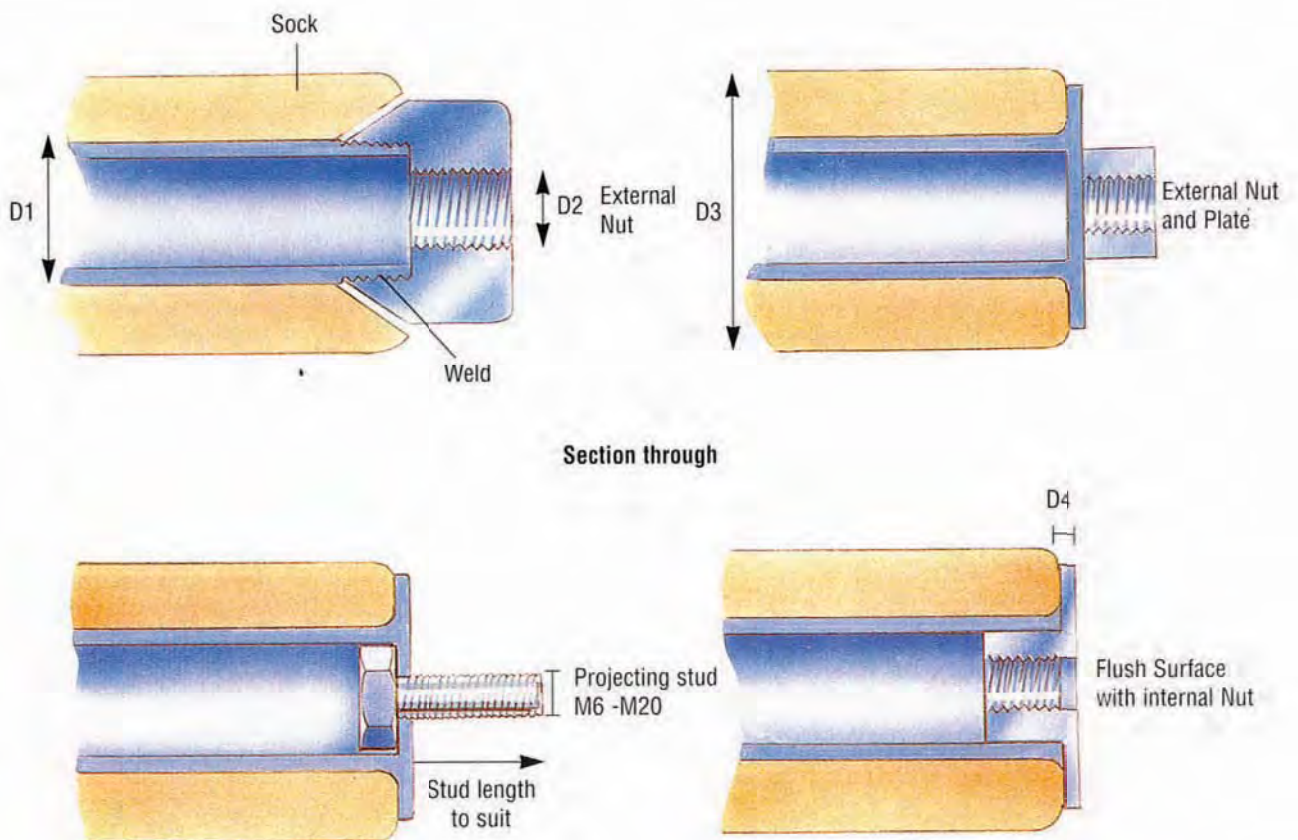

RWT and WSA Standard Welded Attachments

SECTION SIZE			
D1	D2	D3	D4
15 x 15	M6 to M16	30mm to 80mm	1.5mm to 4.0mm
20 x 20	M6 to M20	40mm to 140mm	1.5mm to 4.0mm
30 x 30	M6 to M30	60mm to 200mm	2.0mm to 6.0mm

SELECTED ATTACHMENTS

TYPE RAC

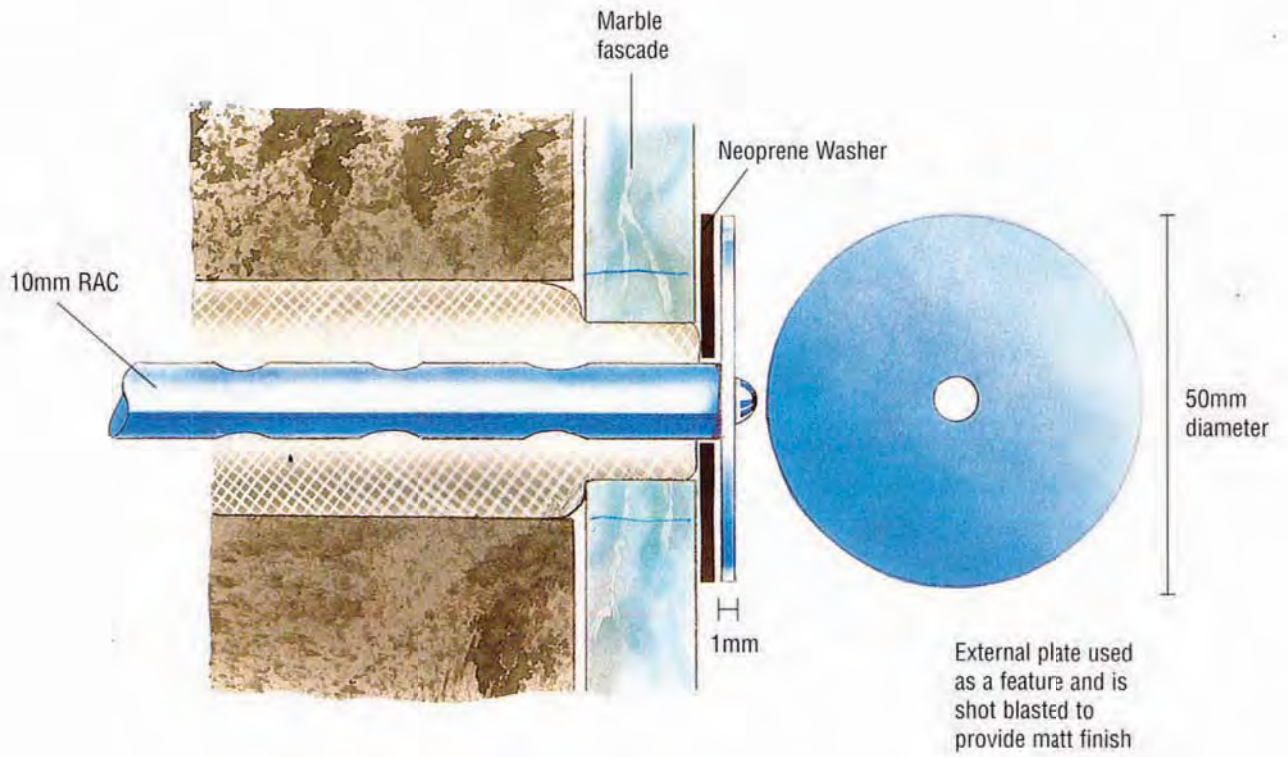

WALL TIE LATERAL RESTRAINT APPLICATION

TYPE CHS, SHS, ST

Typical cavity wall consolidation
restrained to floor joists

CHS

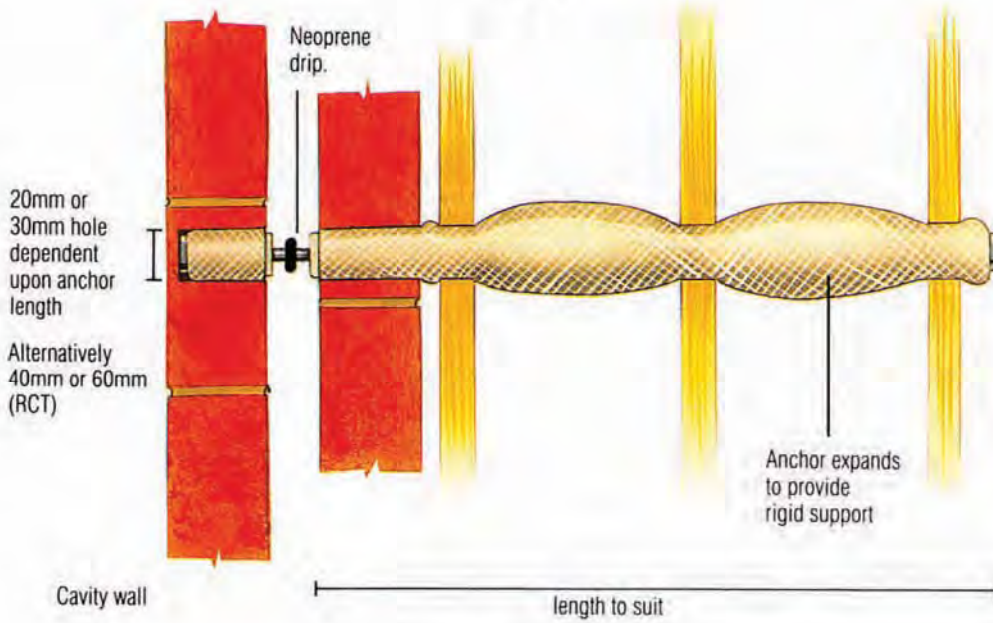

SHS/ST

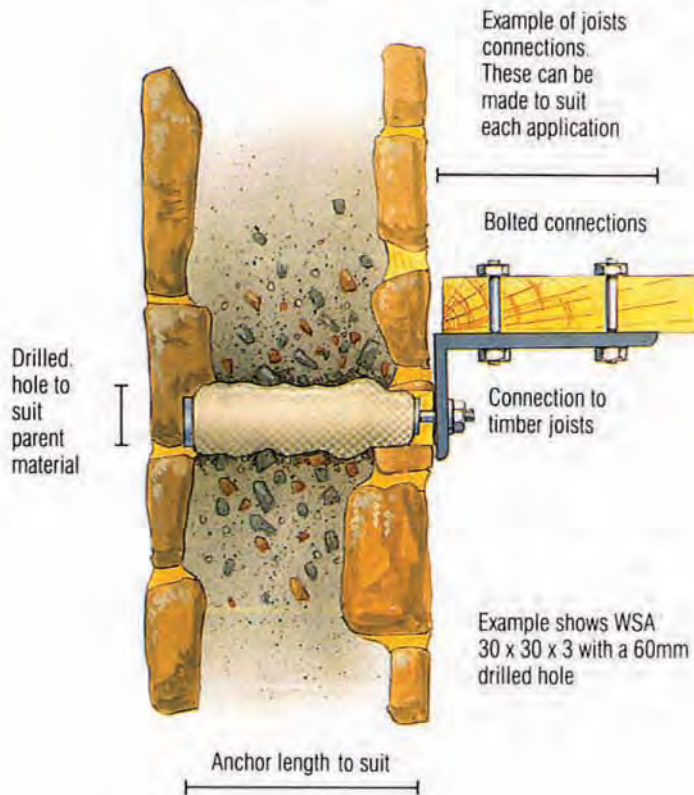

Typical Random Rubble Wall
Consolidation Restrained to Floor Joist

REPLACEMENT WALL TIE

TYPE RAD

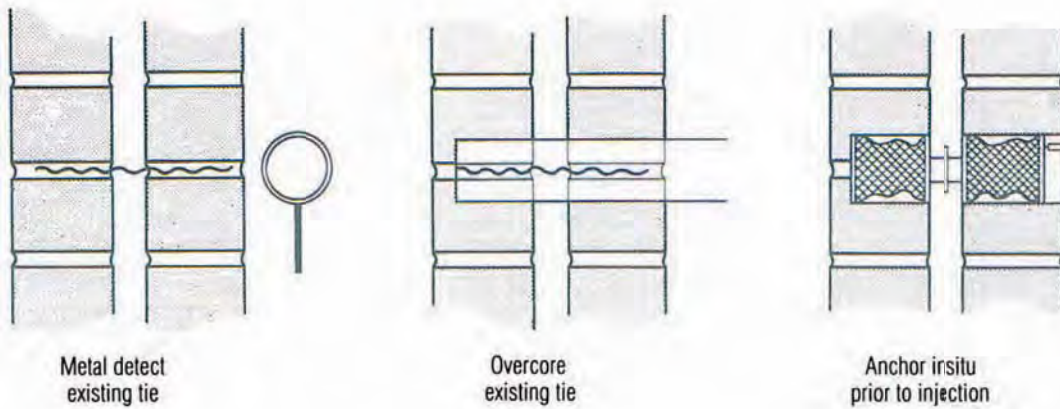
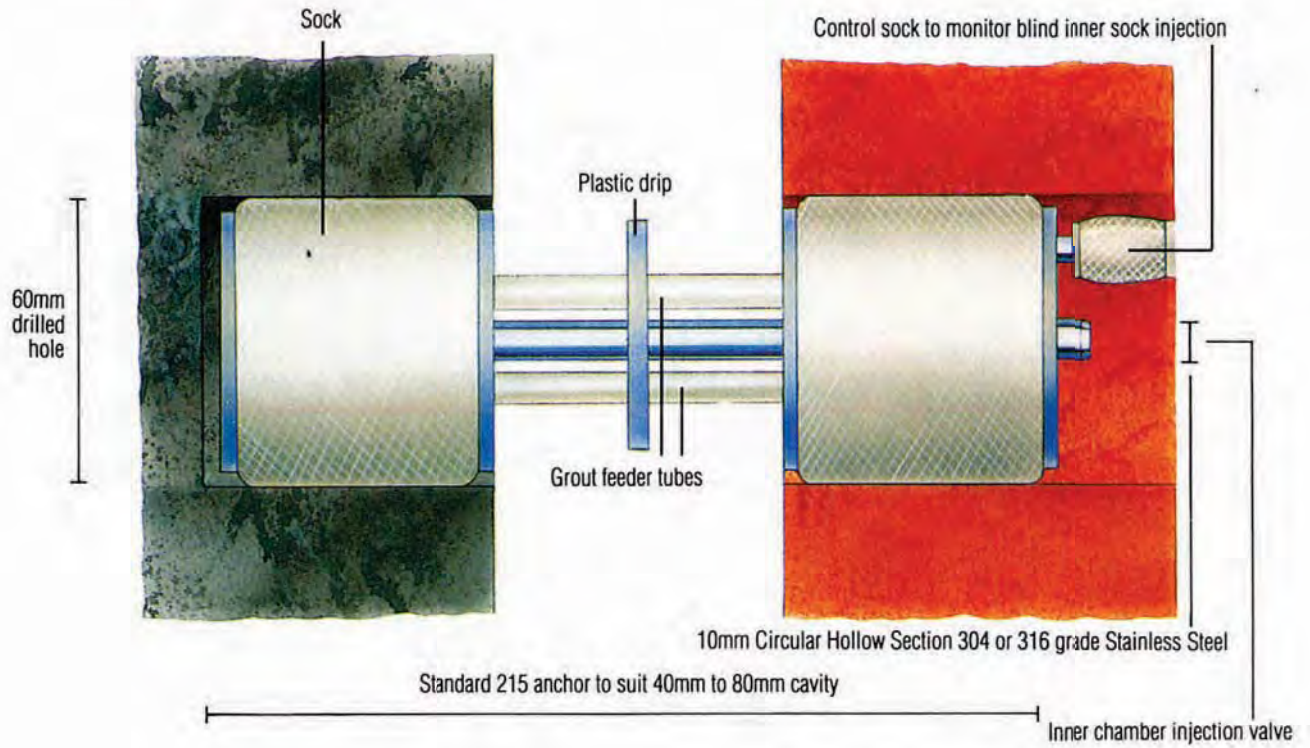

STITCHING ANCHOR

TYPE CHS

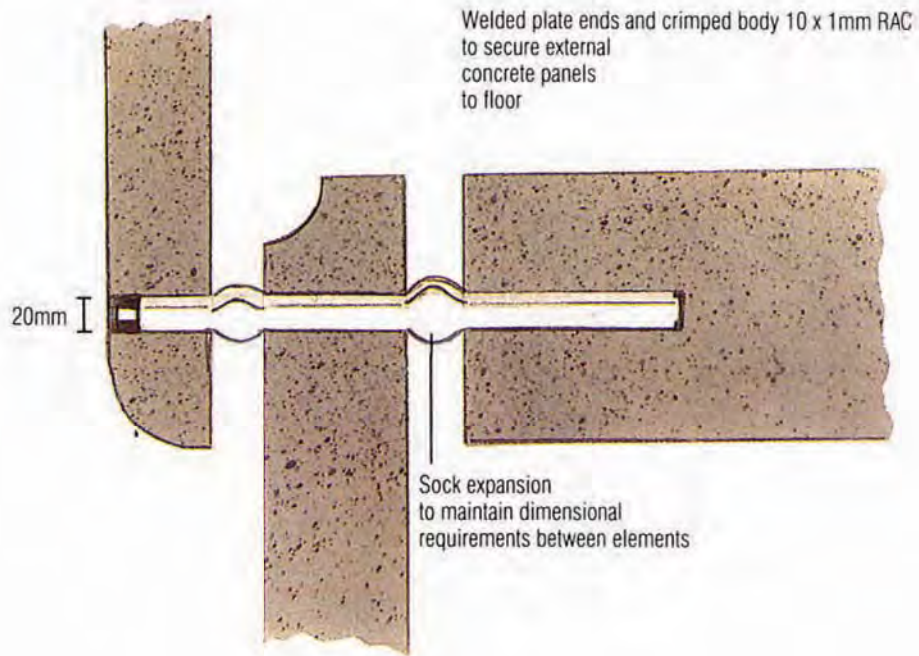

Concrete Sandwich Panel

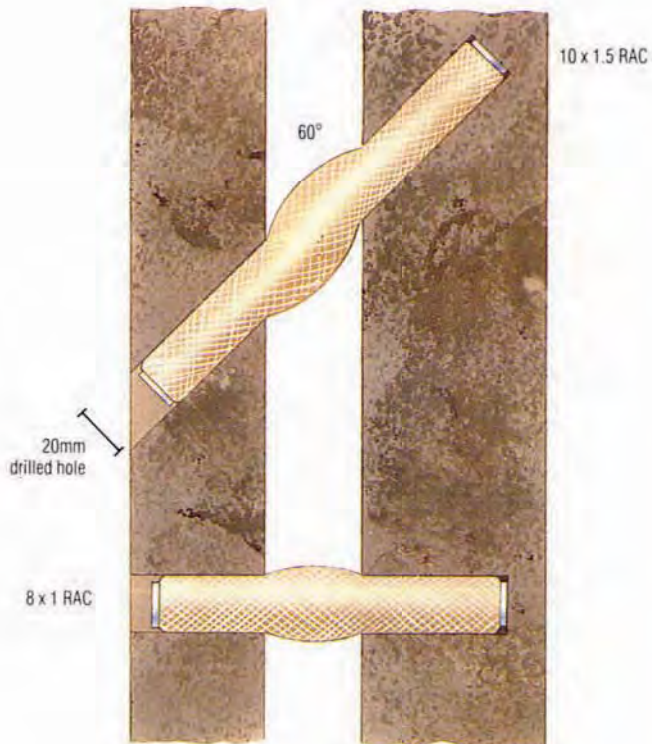

Brickwork Sandwich Panel

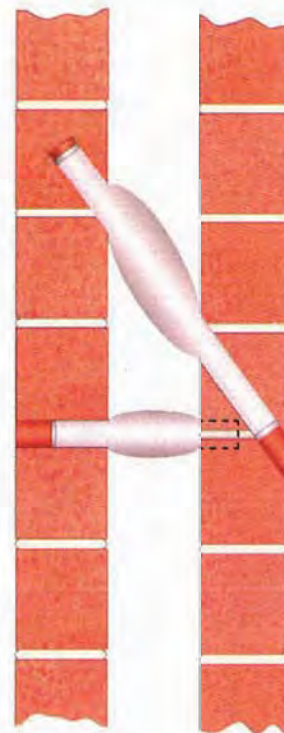

STITCHING ANCHOR

TYPE CHS

Can be used in all construction materials. Illustration indicates cavity wall, but this solution can be used in solid construction

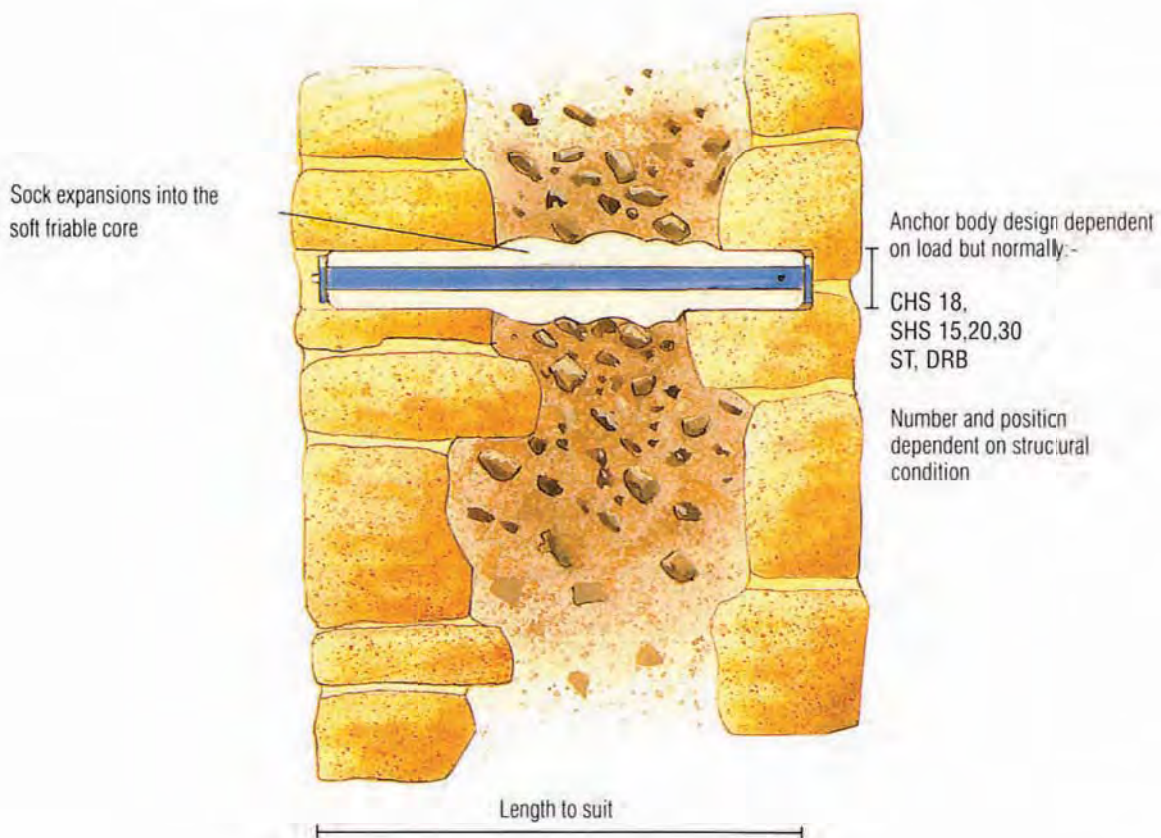
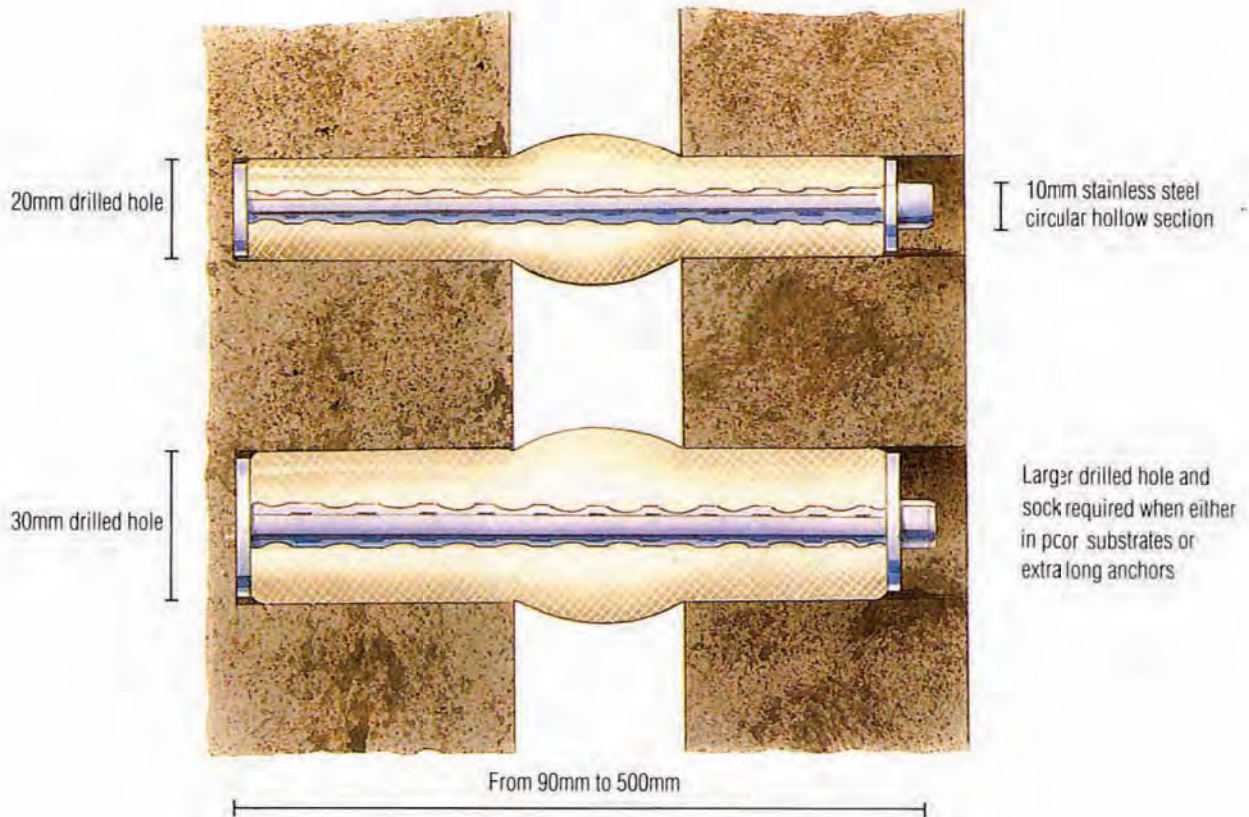

STITCHING ANCHOR

TYPE RWT & WSA

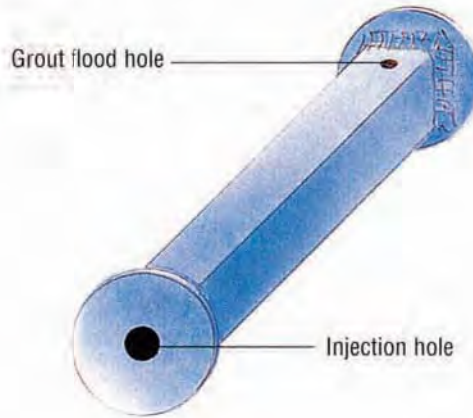
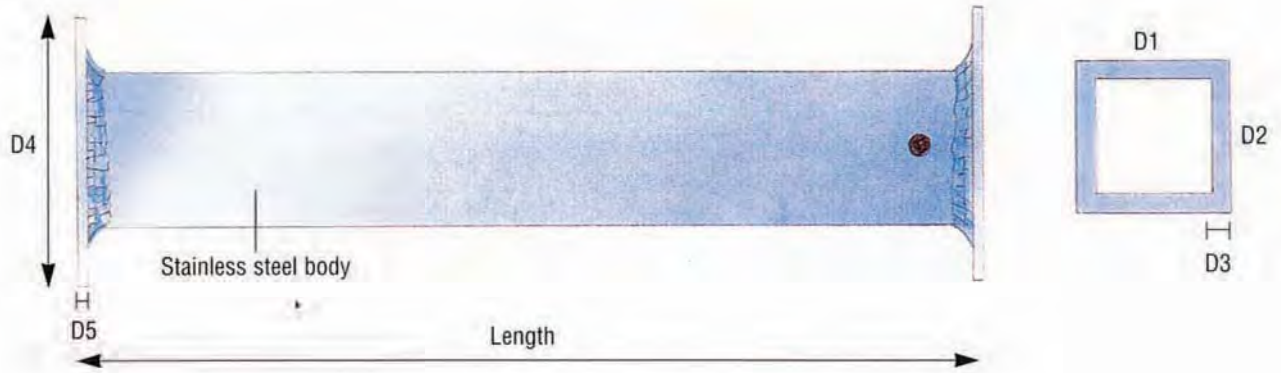

	D1	D2	D3	D4	D5	LENGTH	STANDARD DRILLED HOLE SIZE FOR GOOD SUBSTRATES
RWT 15	15mm	15mm	1.5mm	28mm	3mm	as required	30mm
RWT 20	20mm	20mm	2.0mm	36mm	3mm	as required	40mm
WSA 30	30mm	30mm	3.0mm	52mm	3-4mm	as required	60mm

STITCHING ANCHOR

TYPE MB

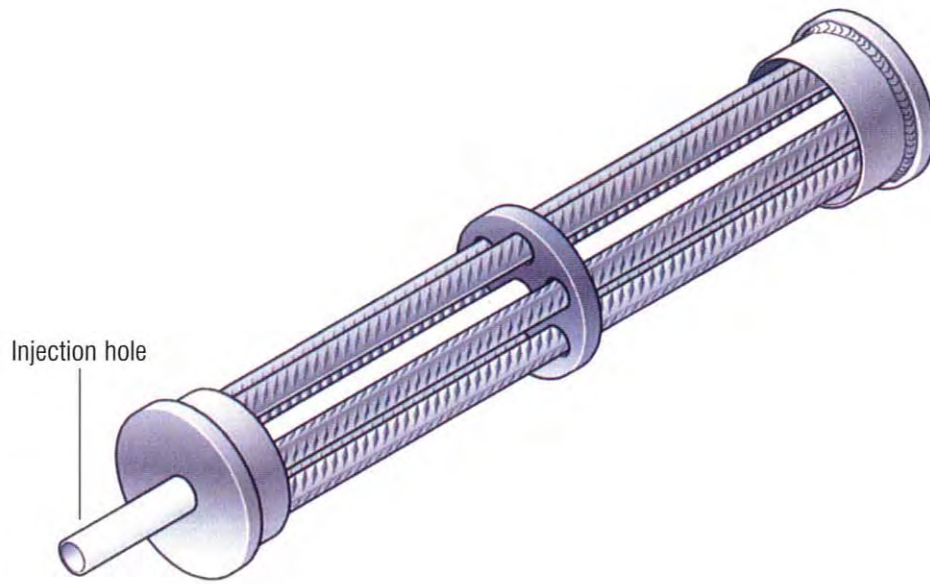
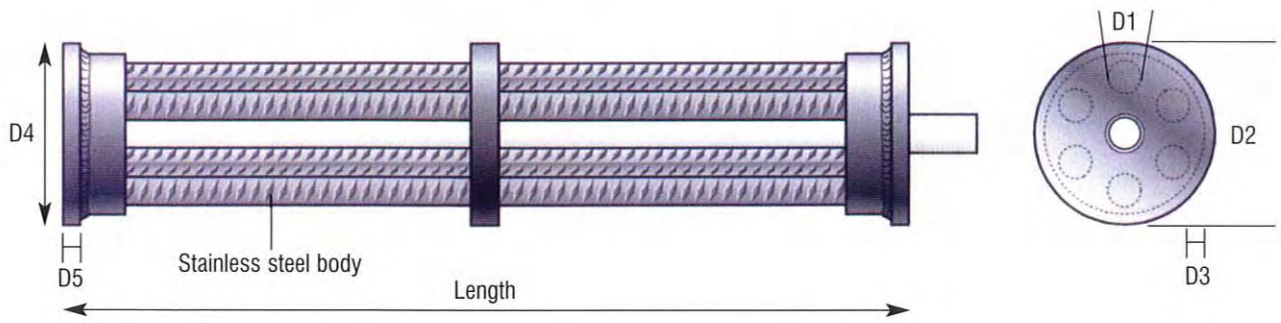

Existing Anchor Type	Cross section area mm ²	D1 6mm dia. Rebar No. of strands	D1 8mm dia. Rebar No. of strands	D1 10mm dia. Rebar No. of strands	Minimum hole diameter	Length	D2 (mm)
RWT 15	81	3			30		26
RWT 20	144		3		40		35
NSA 30	324		7	4	60		50
16mm Solid	201		4		40		35
20mm Solid	314		7		55		37
25mm Solid	491		10	7	65		44

STITCHING ANCHOR

TYPE CHS & MB

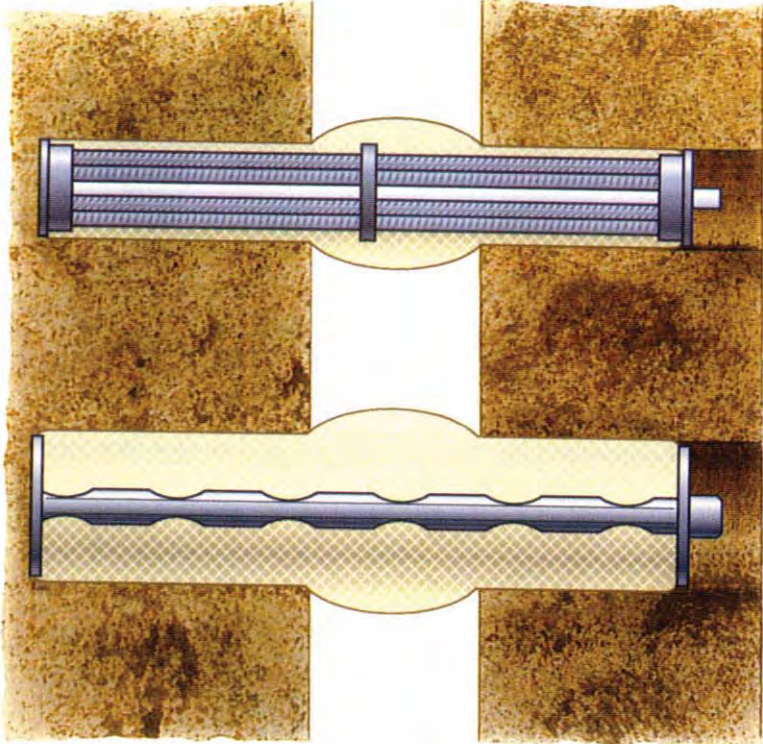

The purpose of the above illustration is to highlight that in weak substrata increasing the diameter of the bore hole can be an advantage to reduce shear stress.

∴ The anchor body should remain the same for both 20 diameter & 30 diameter holes.

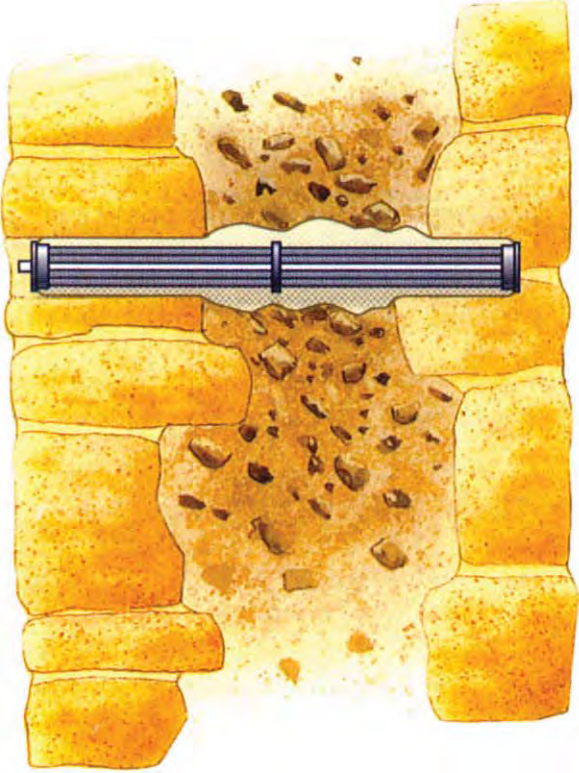

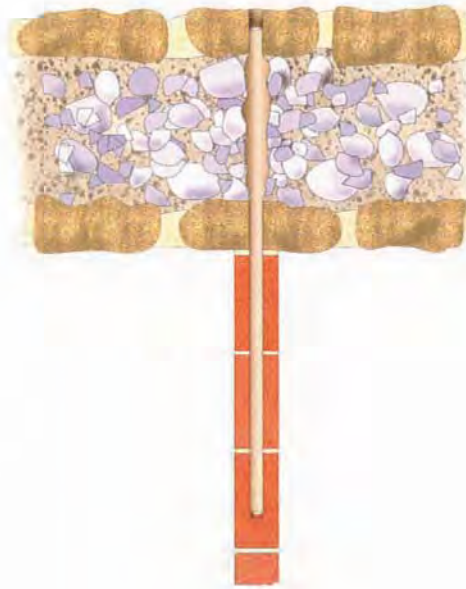

Internal Wall Connection Detail

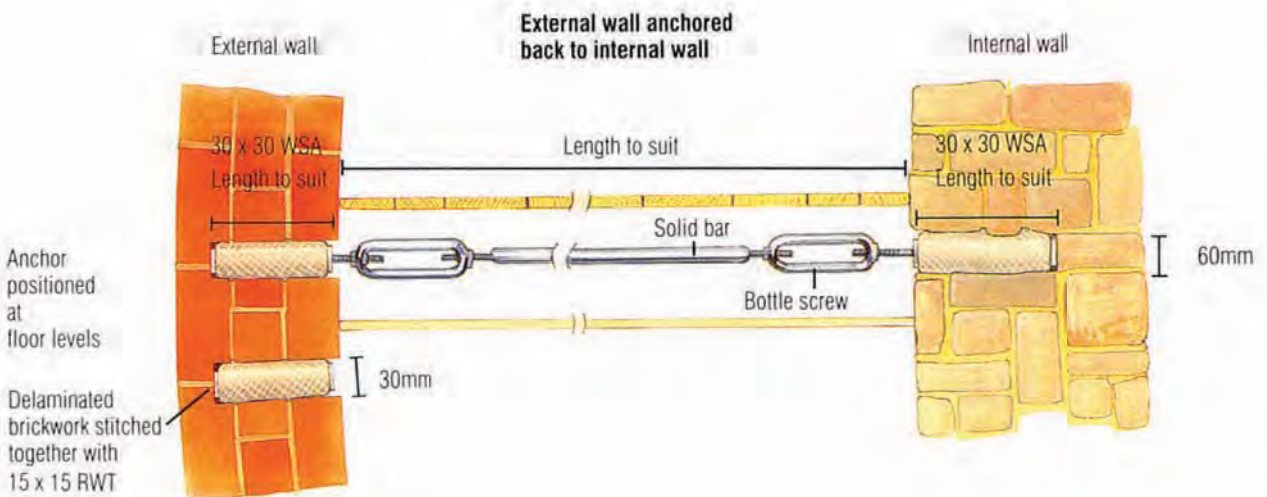

Anchor positioned at floor levels
 Delaminated brickwork stitched together with 15 x 15 RWT
 Positioned at 900 x 450 centres dependent upon wall condition

Typical anchor detail indicating the bulging and delaminating external brick wall to a solid internal wall

STITCHING ANCHOR APPLICATION

TYPE RWT

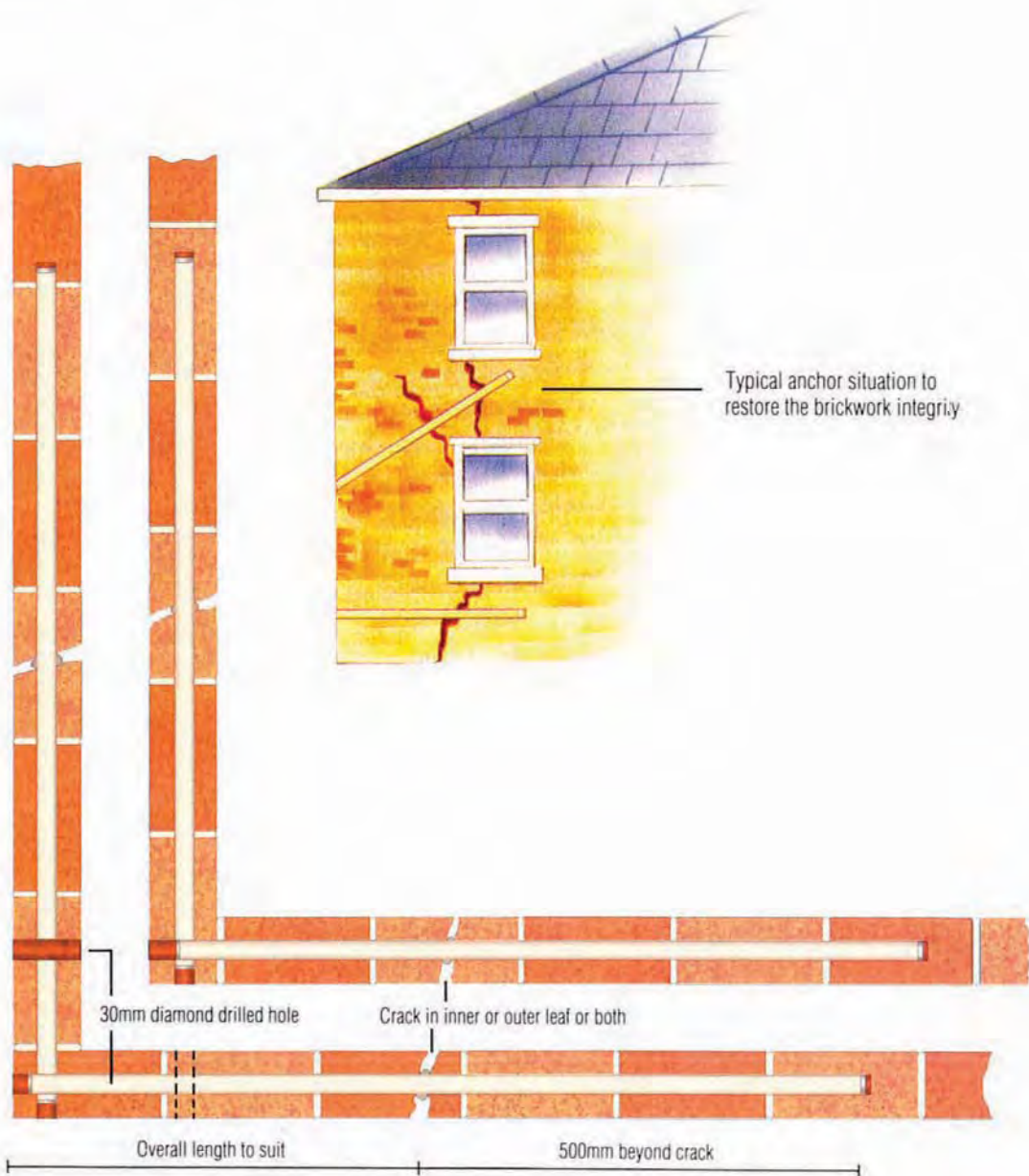
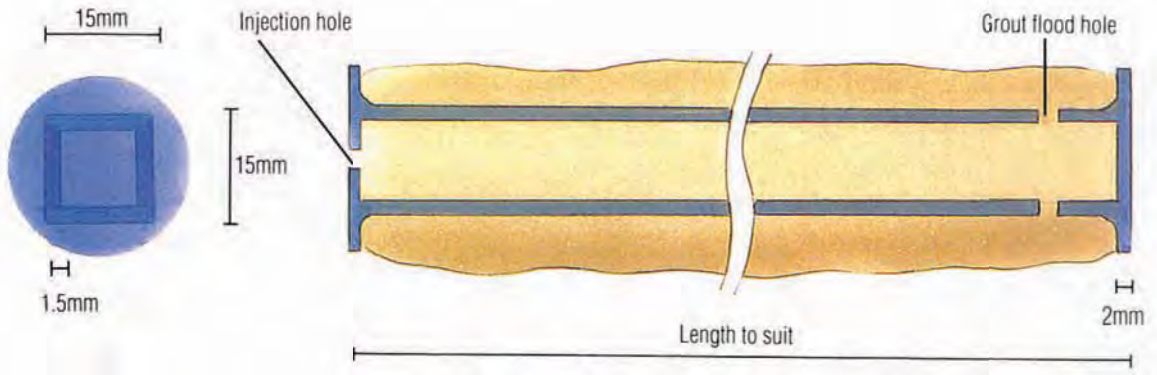

STITCHING ANCHOR APPLICATION

TYPE JRA

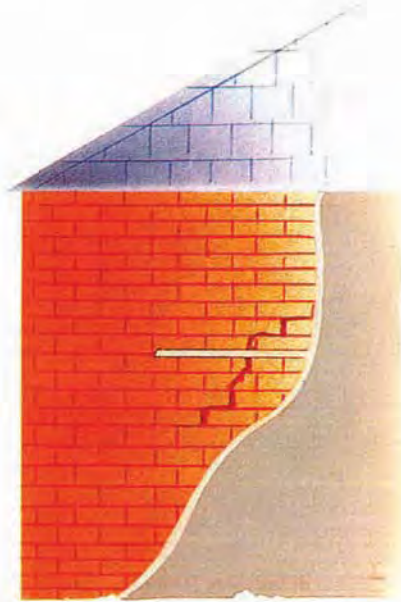

Anchor is installed sideways into wall in a slot cut using diamond or abrasive discs

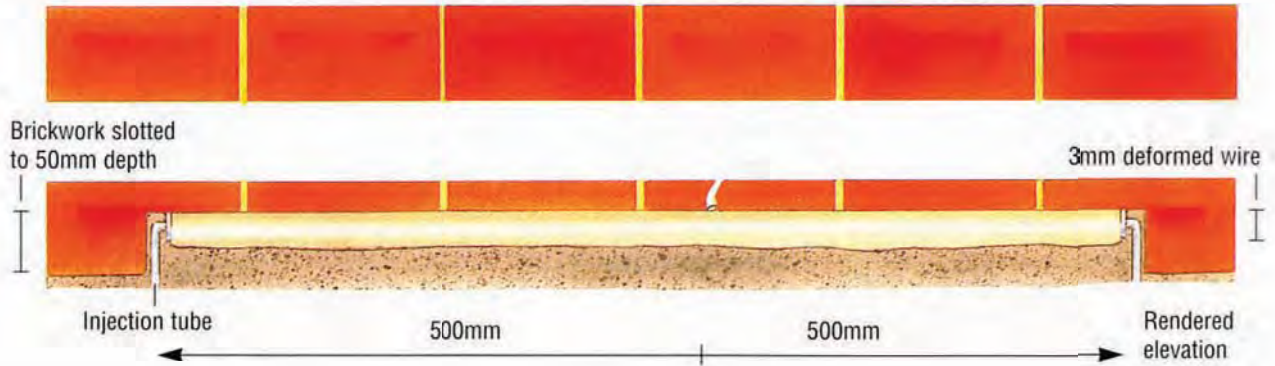

Similar design to above but no fines concrete

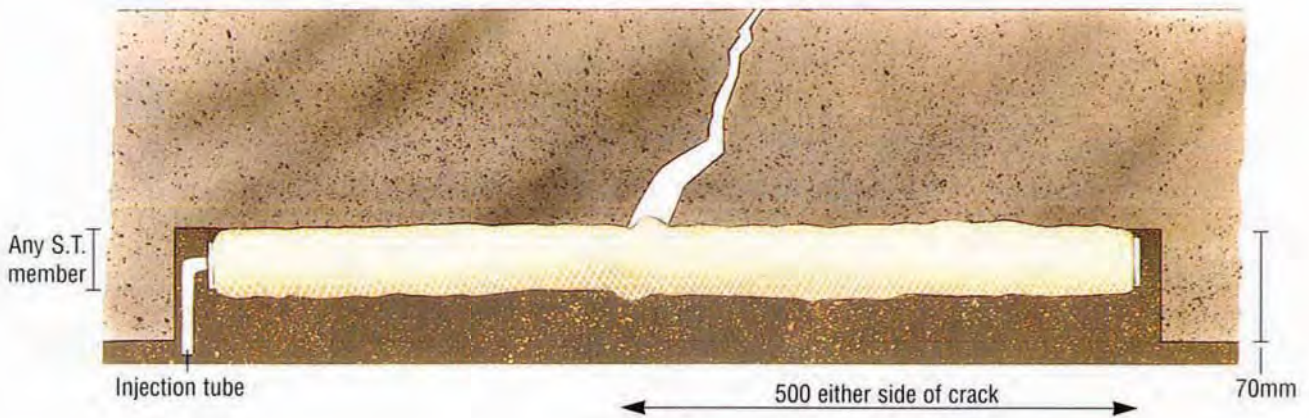

BRICK REINFORCEMENT

TYPE JRA

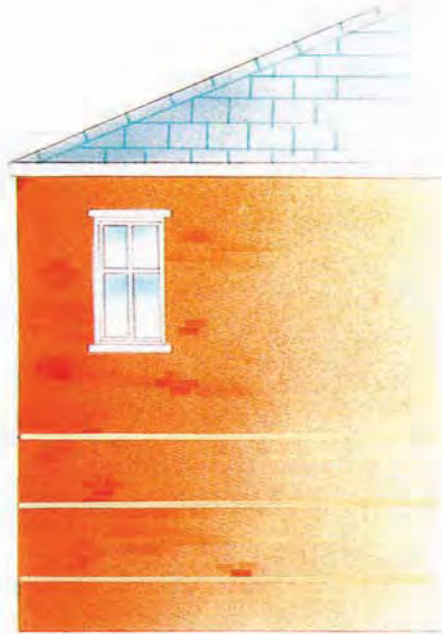

Brick supporting anchor used to reinforce brick joints that are weak and friable

Everything 6th course but dependent upon mortar strength



Raked out joint to 50mm

3mm stainless steel wire with crimped indentations

Expanded sock

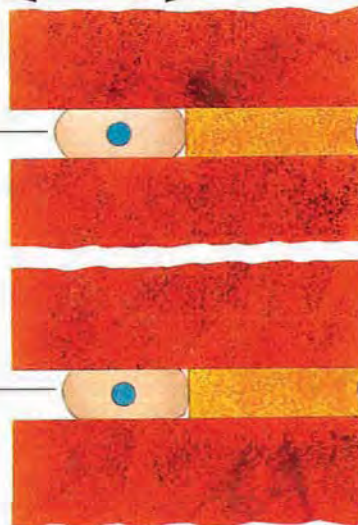

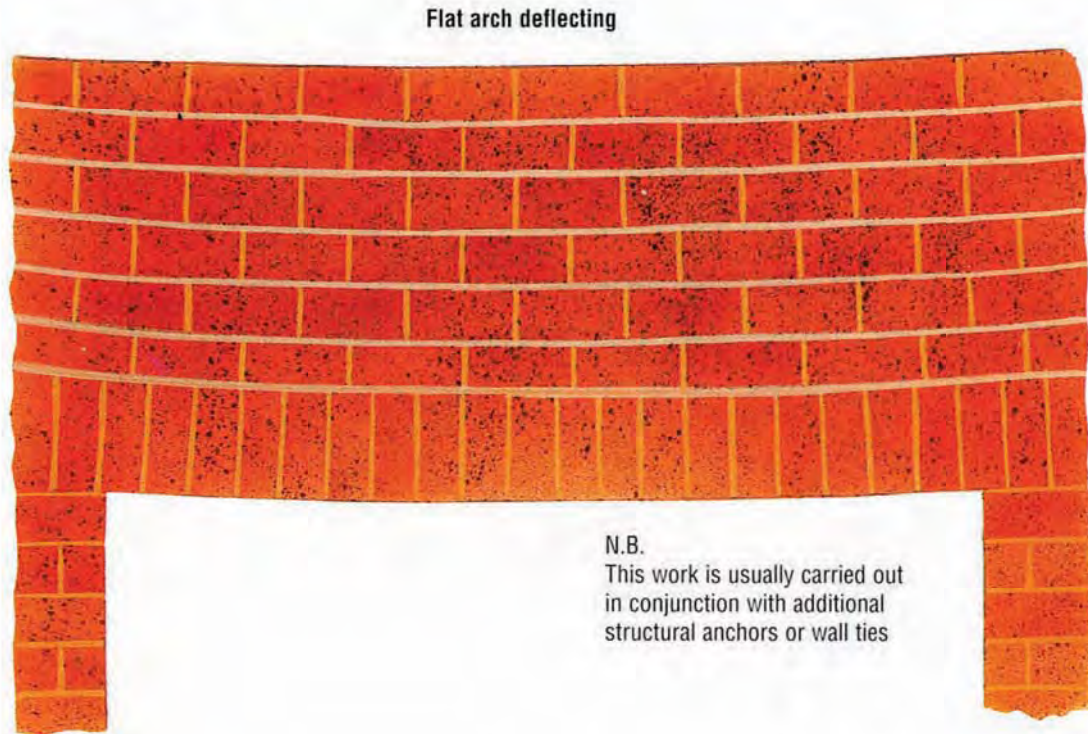
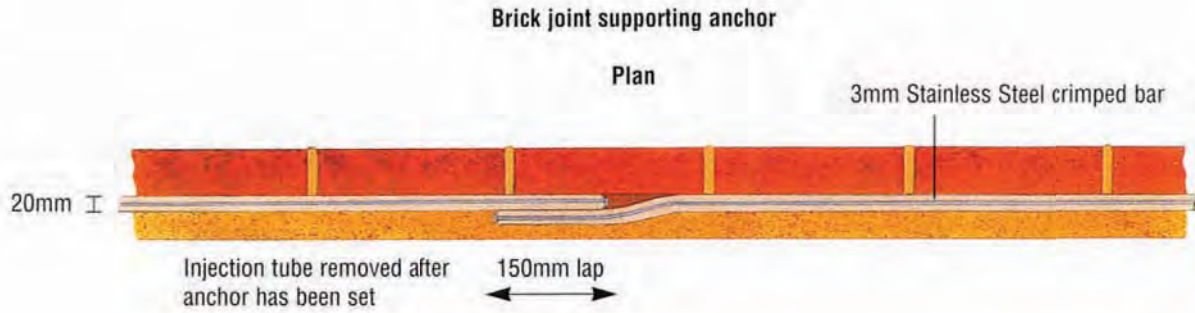

Brickwork reinforced by using
remedial brick joint supporting
anchor to create a brick beam

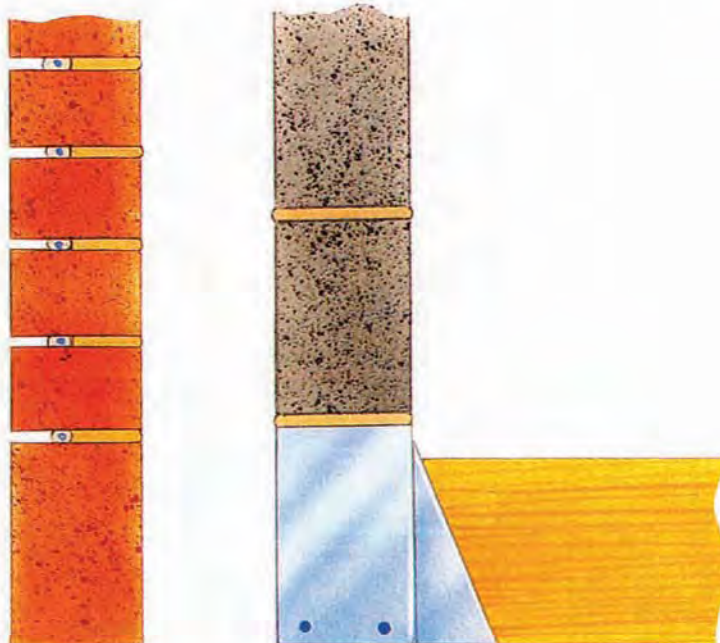

STITCHING ANCHOR APPLICATION

TYPE CHS

Typical Consolidation of Random Rubble Wall

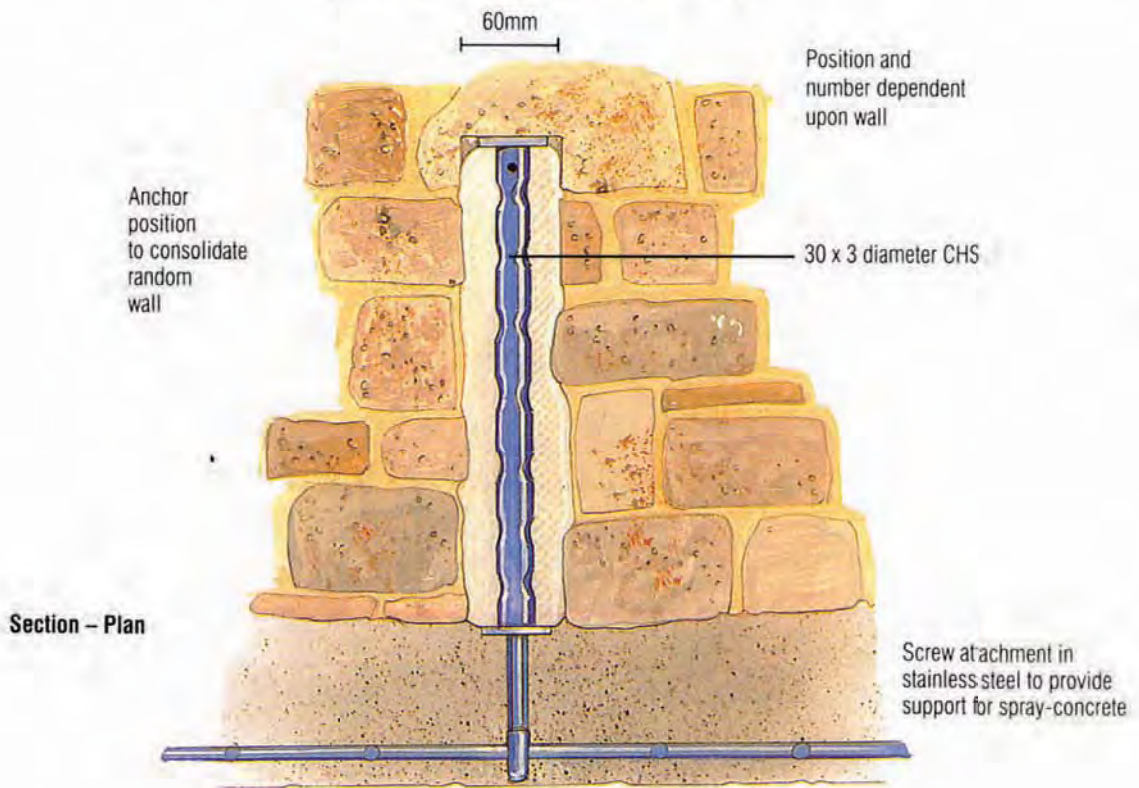

Typical detail of random wall consolidation using circular hollow section to overcome difficulties that arise when the wall is badly deformed and avoid the need to have differing anchor lengths

Treatment to secure friable stone face

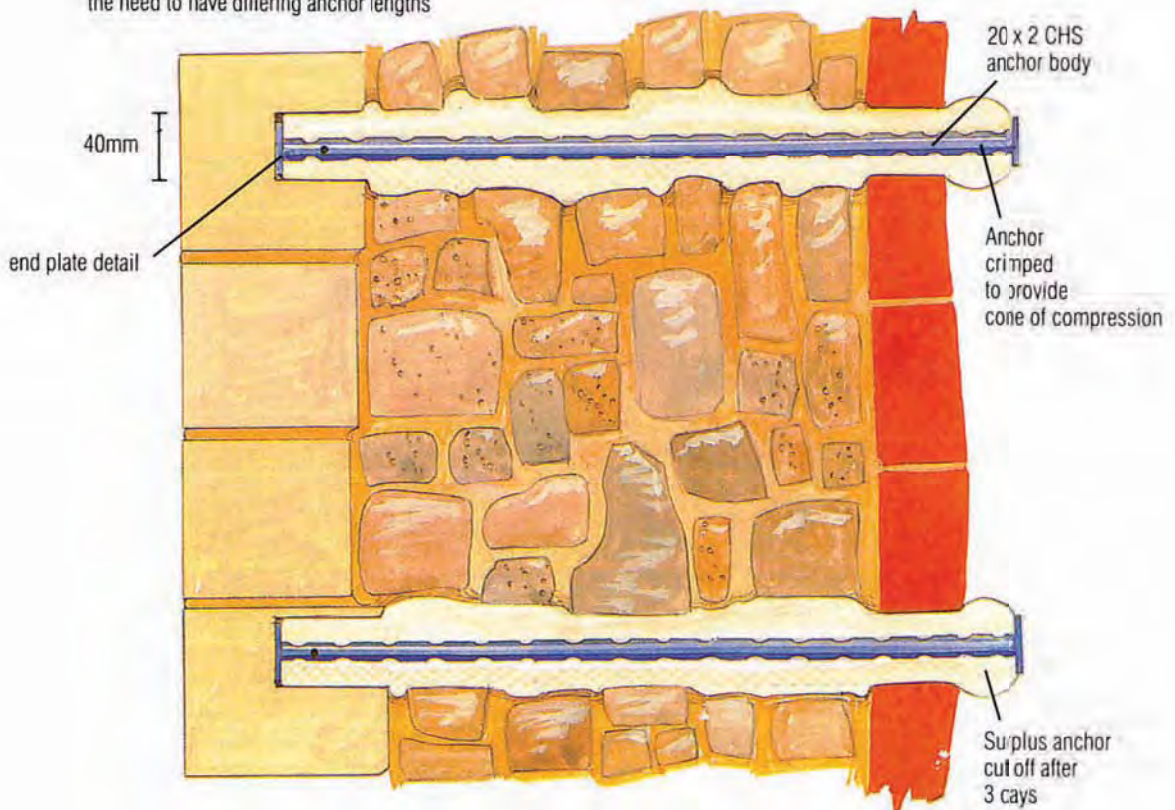

Brick Facade Supporting Anchor

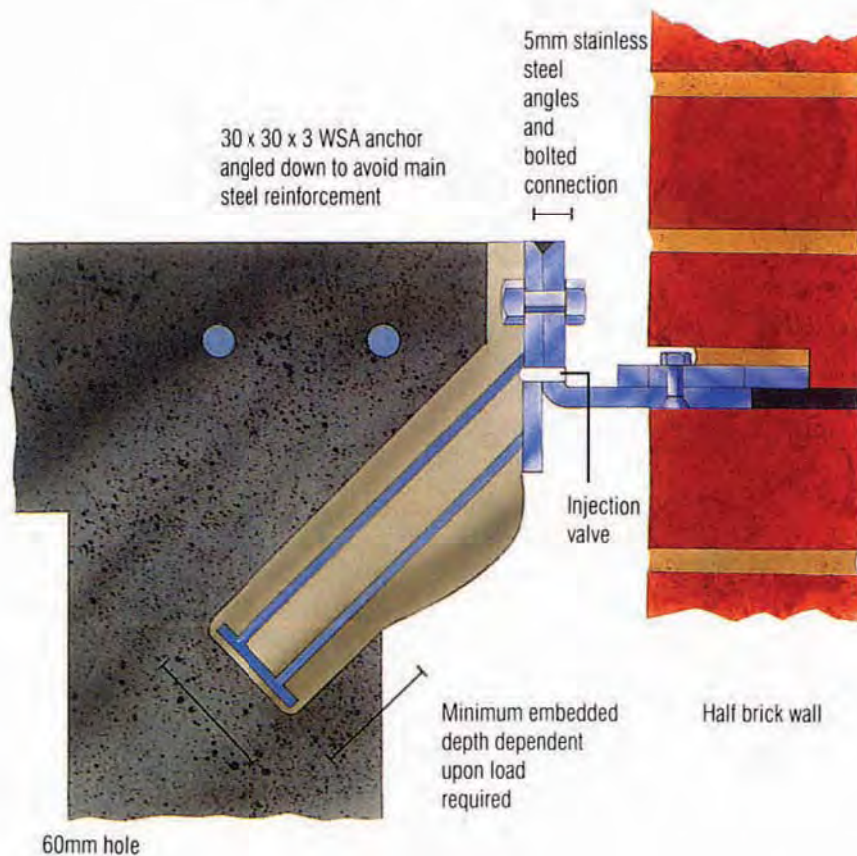
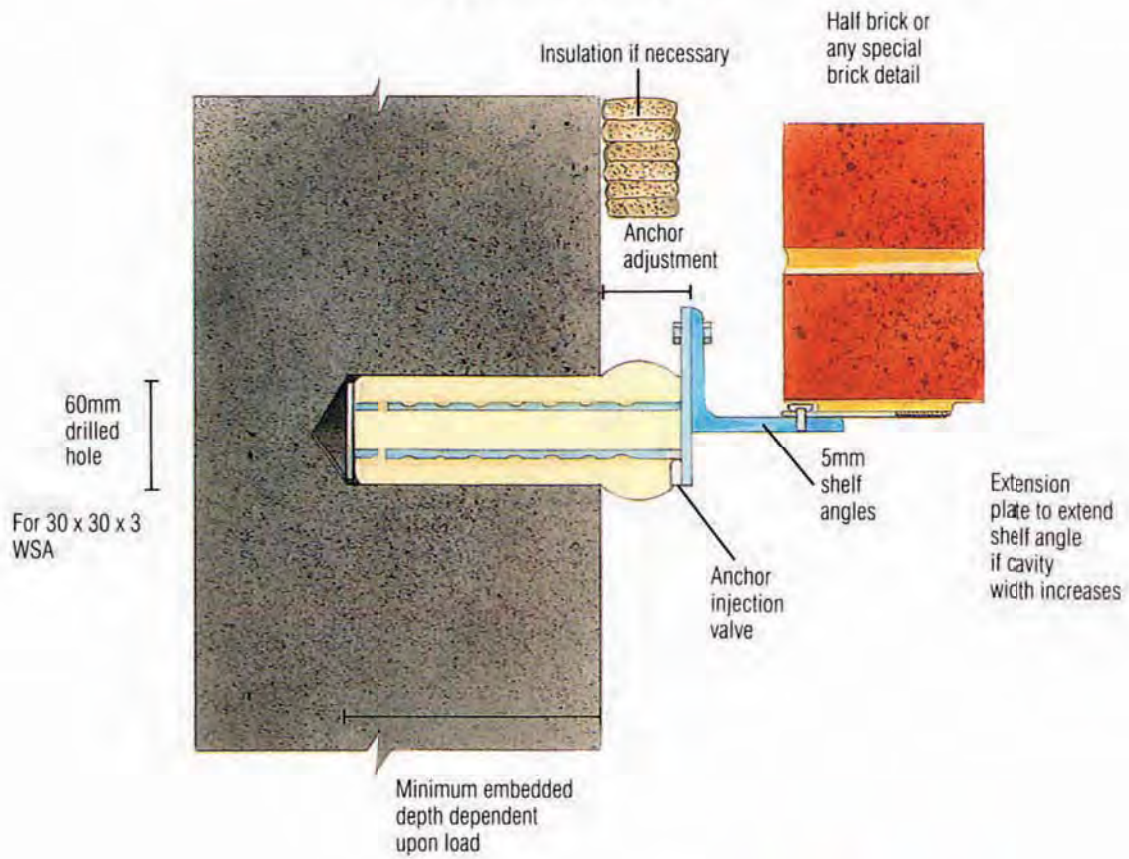

Brick Facade Supporting Anchor

CORBEL ANCHOR

TYPE SHS

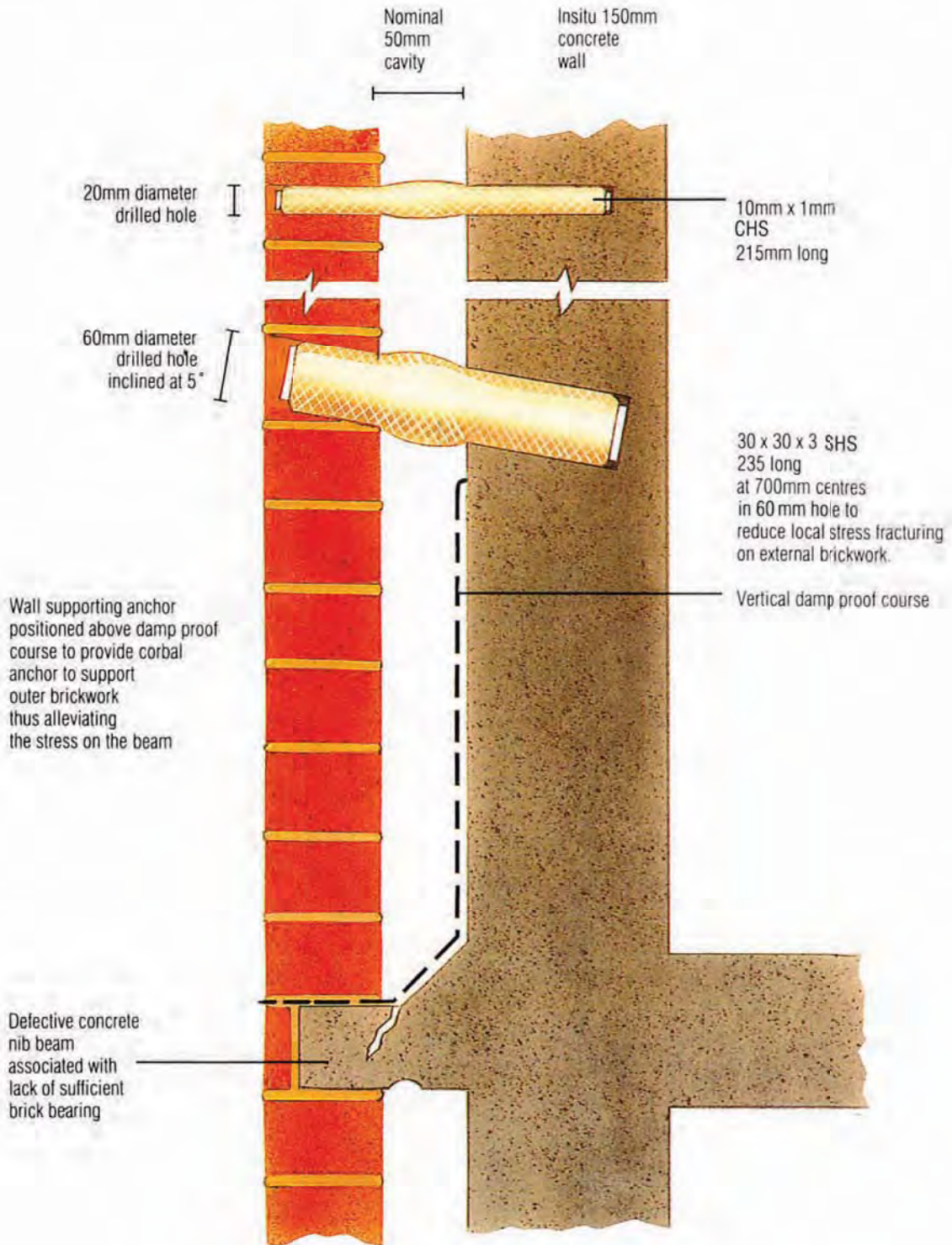

Stitching Anchor – Gas Explosion Hollow Floor Ties

SECTION

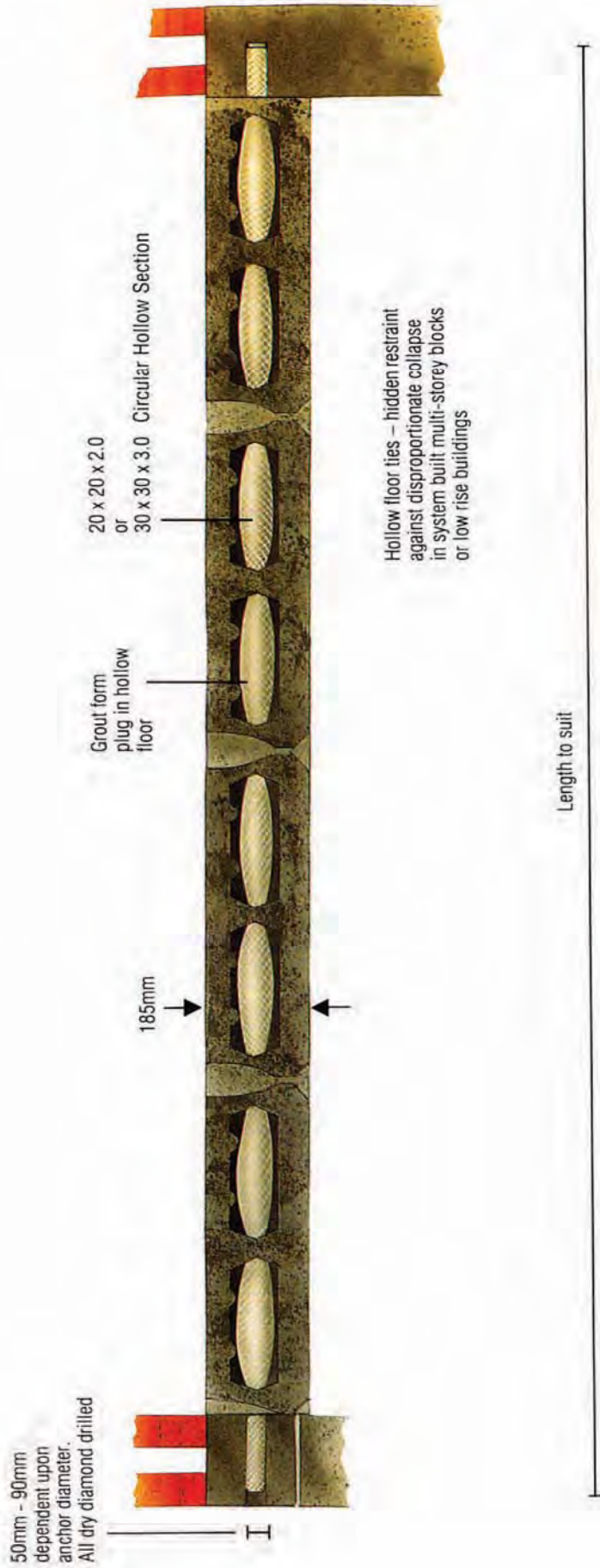

Example shows 8 metres of 20 x 20 x 2 Square hollow section
316 stainless steel

STITCHING ANCHOR APPLICATION

TYPE CHS, SHS, ST, DRB

Typical Brick Stitching Anchor Detail to brick Arch

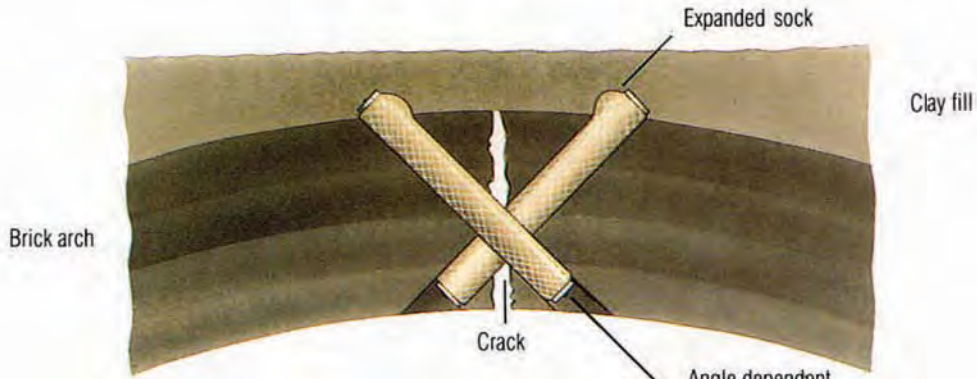

Anchor section to be either:-

- 30 x 30 S.H.S. grade 304, 316
- 20 x 20 S.H.S.
- 15 x 15 S.H.S.
- dependent upon load
- CHS/ST20/DRB 32

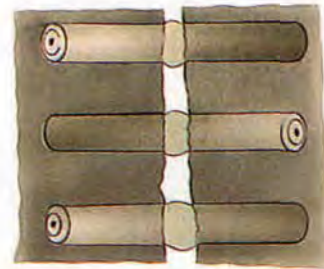

Plan View

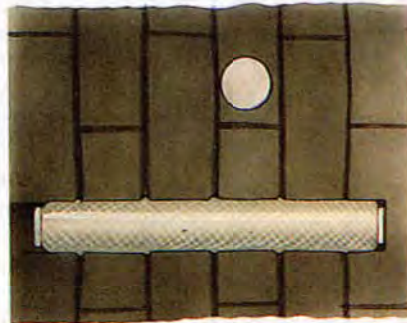

Drilled hole dependent upon anchor size

- 30 x 30 = 60mm
- 20 x 20 = 40mm
- 15 x 15 = 30mm

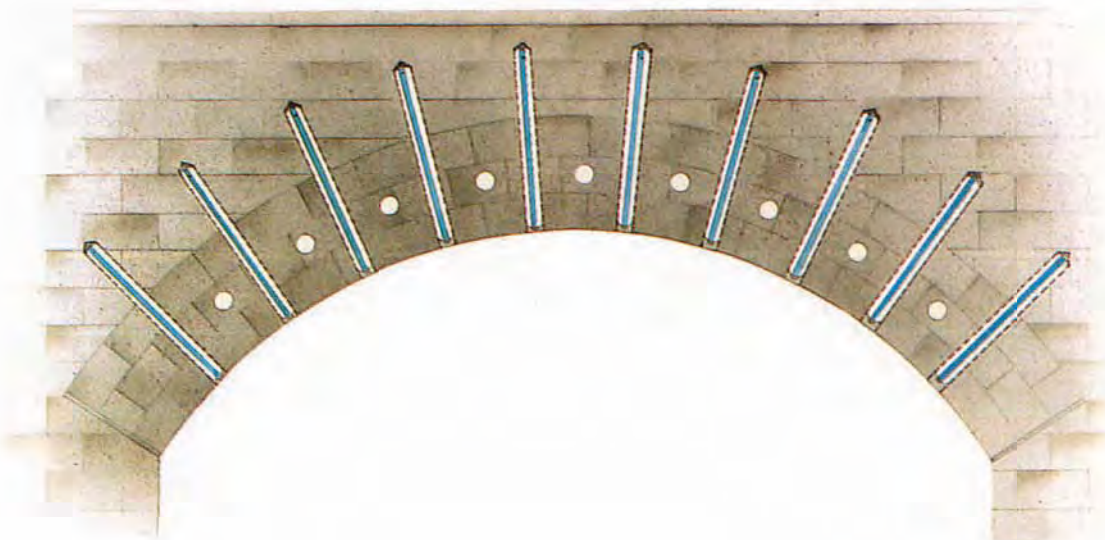

STITCHING ANCHOR APPLICATION

TYPE CHS

Typical Arch Consolidation

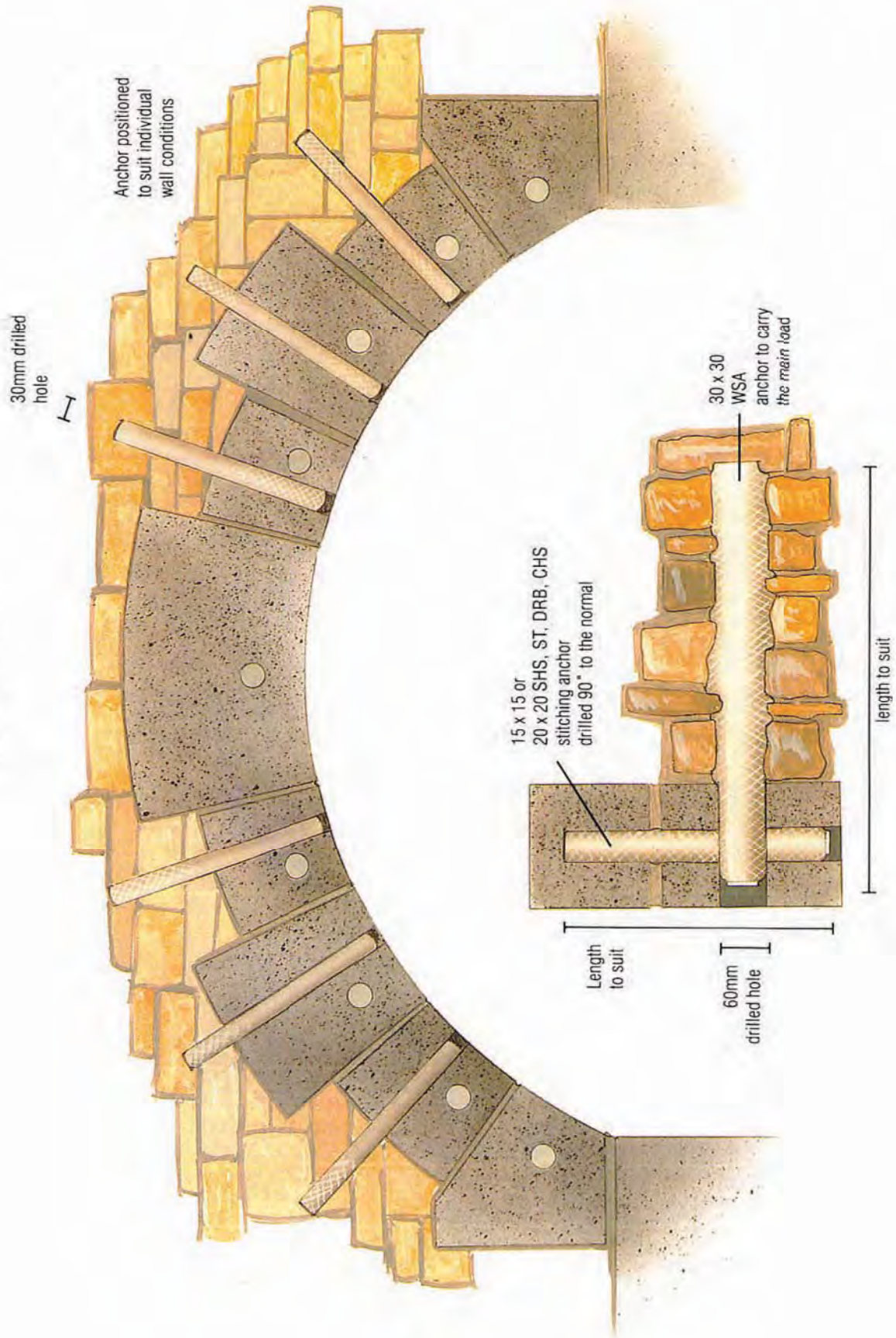

STITCHING ANCHOR

TYPE ST, DRB

Example of Heavy Duty Anchor

Example shows the locking of the structures in brick viaduct. The overall length and drilling diameter can be varied dependent on loads and control required

Double corrosion protection in centre section with DENSO tape wrapping

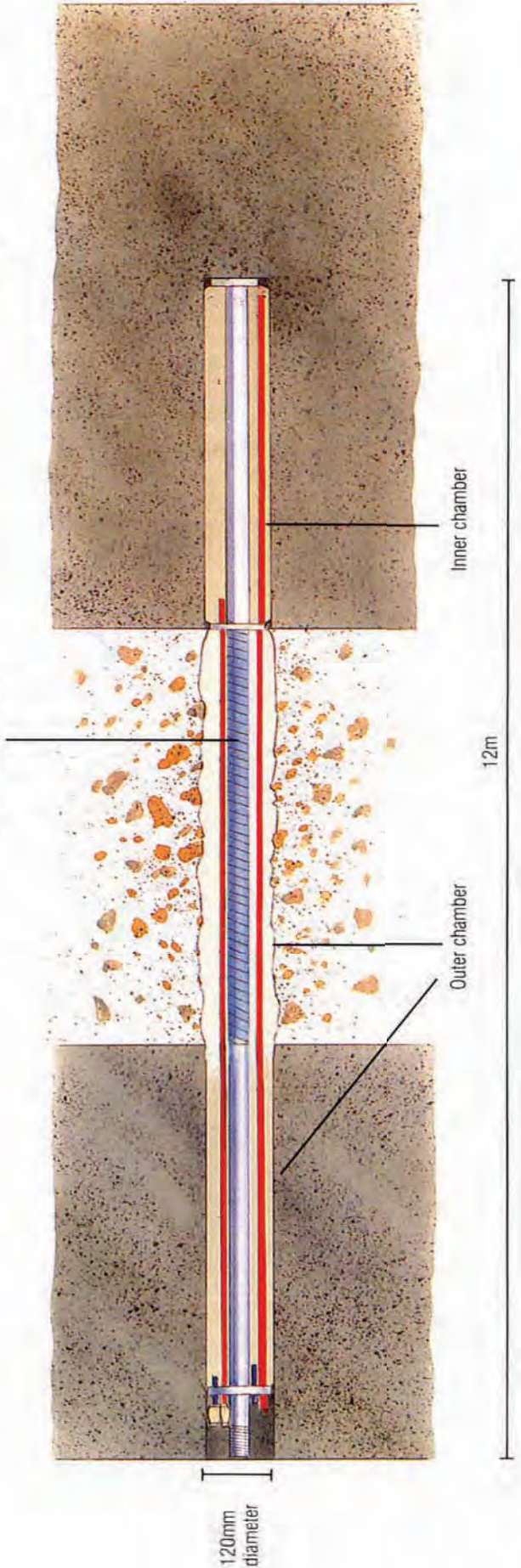

120mm diameter

12m

Inner chamber

Outer chamber

CINTEC

Case Histories

CASE HISTORY

Cintec's first project in North America

Marco Island Sea Wall – Florida, USA

March 1983- Following a move from Germany to a new home on a Florida island, Civil Engineer Paul Pella was faced with a structural problem common to the region – subsidence and dislocation of the protective sea walls surrounding the homes built upon the island.

Fortunately for Mr. Pella, his engineering experiences back in Europe provided him with an innovative new technology ideally suited for stabilizing these concrete structures – Cintec Anchors. The ground behind the walls consists essentially of sand, not considered an ideal medium for any form of anchorage. However the adaptability and unique features of the Cintec system overcame any potential difficulties associated with this soil type.

Consisting of a steel rod enclosed in a mesh fabric sleeve, the principle of the system is to inject a specially developed cementitious grout into the restraining sleeve of the anchor and so inflate it along its entire length. As well as providing an extremely strong mechanical bond, some liquid or 'grout milk' passes through the material membrane and bonds with the original substrate beyond.



In the case of Marco Island, an additional wide section of expandable sleeve, or sock as it is often called, was attached to the far end of the anchor. When the grout was injected, the additional section expanded to a diameter greater than the rest of the anchor. This created a bulb deep within the soil and ensured a truly secure point of anchorage.



As can be seen in the images (right) the individual boreholes were produced by diamond core drilling, in this case with a core diameter of 65mm (2 ½") and to the length of the anchor : 3.2 meters (15ft) – Fig 1. The anchors were then installed with a plastic half pipe to facilitate their insertion – Fig 2. Finally the anchors were injected with 'presstec' cementitious grout expanding them from their far end to the front. Although not essential, a flange – plate was also screwed to the exposed anchor end for additional securement – Fig 3.



ARCHTEC

BRIDGE REINFORCEMENT SPECIALISTS and Masonry Bridge Repairs

Bridge Requirements:

Many masonry arch bridges still in use by highways, railways and waterways are over 100 years old. Most were never designed to carry the traffic loads to which they are now subjected. Modern lorries with cargos can weigh forty tonnes and a new European directive now requires all major trunk road bridges be capable of 40 tonnes axle loading.

The Archtec Response:

Archtec provides a unique bridge reinforcement system – a complete diagnostic, design and installation service, utilizing state of the art technology and drilling methods specially designed to strengthen masonry arch bridges. The anchors spread the traffic load, taking pressure away from the arch's critical points of highest stress. The system has an added advantage in that it often requires no bridge closure during the installation process. It allows bridges to be quickly and economically upgraded to the desired load bearing capability and with no visible change to the appearance of the structure.

Over 300 bridges had been strengthened with Archtec by 2012.

Tried & Tested

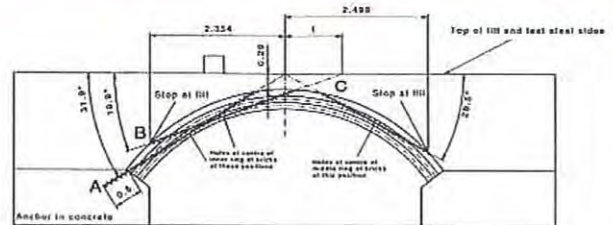
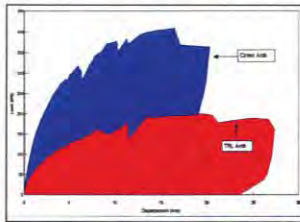

FRONT ELEVATION

Testing: Strength and Flexibility:

Large-scale tests have been undertaken both on functioning bridges and also at the Transport Research Laboratory near London. In the example illustrated left, the load failure point of an

un-strengthened model was found to be **20 Tonnes**. Following strengthening with Cintec anchors, their precise location being determined by state-of-the-art design, the load failure point was raised to **45 Tonnes**.

Overall, the following results were demonstrated:

- Load-bearing capacity of the arch is more than doubled
- The first crack or hinge does not occur under the load line
- The installation of Cintec anchors delays the formation of hinges
- The bond between the masonry and the anchors is sound
- The strengthening is relatively quick and easy to install
- The system adds significant flexibility and elasticity to the structure

Environment:

In many ways, the Archtec system is a wise environmental choice:

- It typically consumes 90% less energy than conventional bridge strengthening methods.
- It does not cause pollution to waterways
- It does not deface the appearance of structures and bridges
- Archtec construction areas have a small 'footprint'
- It causes little or no delays or redirection of traffic.

CASE HISTORY

Bridge Trials Verify Increased Bridge Serviceability With Archtec Strengthening

Extensive verification has long since been established for both the method of strengthening masonry arch bridges known as Archtec as well as for the use of ELFEN Finite/Discrete Element analysis as a basis for assessment and design. This has included several fullscale tests.



Consistent with other contemporary work on masonry arches and current assessment/design methods, the verification and testing which forms the current design basis for Archtec has focused primarily on predictions and comparison of ultimate strength. However, unlike other methods of arch assessment/design, Finite/Discrete Element analysis also allows the consideration of arch behaviour in the elastic range under service loads and some analytical work has been undertaken to investigate this although it has not been possible to fully verify this in the absence of the suitable test data.

In the course of discussions with the Bridge Owners Forum (BOF) Masonry Arch Subgroup, regarding the more widespread adoption of Archtec, the benefit of a Supplementary Load Test to investigate the behaviour of unstrengthened and strengthened arches under service loads was identified. At meetings between the BOF, Gifford & Partners and Cintec, a bridge already earmarked for Archtec strengthening and was selected for testing under service loads. The load tests, were carried out in two stages, before and after strengthening, and were undertaken using the guiding philosophy laid down in BA 54/94 Load Testing for Bridge Assessment. The second of the two tests was completed on 1 March 2004.



The Bridge

Pop Bottle Bridge in South Lincolnshire is a skewed twospan brick masonry arch bridge. Each span is approximately 5.0m measured in the skew direction and rise at their crowns 2.3m. The barrel is built from three rings of brick with bricks laid to the English or Helicoidal Method and has a skew angle of 25°. The overall barrel thickness is 355mm. The central pier is 800mm wide and approximately 2.1m high. Using modified MEXE and mechanism analysis the live load rating of the bridge was originally calculated to be 13 tonnes. The construction and previous use of Pop Bottle Bridge make it an ideal representative of British arch bridge stock and the disused and dismantled railway permitted easy access for test instrumentation.

Objectives: The primary objective of the Supplementary Load test was to demonstrate the efficacy of the Archtec strengthening system under service loads, namely:

CASE HISTORY

■ To validate the use of the ELFEN Finite/Discrete Element analytical method to predict serviceability behaviour in unstrengthened and strengthened arches.

To demonstrate that the retrofitted anchors contribute to the structural behaviour under service loads and that the effects are beneficial and measurable.

The bridge was loaded before and after strengthening using two 18 tonne lorries in 28 different positions and instrumented to



Loading using 11.5 tonnes single axles



Typical test simulation illustrating principal compressive stresses; blue, green and yellow reveal increasing levels of compression

record intrados strains, vertical displacements and strengthened bridge anchor strains.

Conclusions:

The following general conclusions can be drawn from the results of the two load tests, on the bridge in its unstrengthened condition and after being Archtec strengthened, and from predictions of their behaviour using numerical simulations:

- i. Based on strain measurements, the Archtec anchors used to strengthen the bridge are stressed under working loads and are contributing to the bridge's stiffness.
- ii. Archtec strengthening reduces tensile intrados macro strains and, therefore, reduces the likelihood of loosening masonry under cyclic live loads.
- iii. Direct instrumentation of cracks and intrados macro strain measurements have demonstrated that Archtec anchors positioned across transverse cracks reduce cyclic opening and closing under repeated live loads. The main benefit of this behaviour would be the reduction in load cycle derived hysteretic damage; opening and closing of cracks under traversing traffic. Reducing this type of damage will almost certainly be beneficial to the bridge service life.

Predictions of strain and displacement made with DE numerical simulations agree well with measured values, both masonry and anchors. Results are conservative because of skew behaviour, transverse load distribution and spandrel wall stiffening.

It has been demonstrated that Archtec strengthening can be designed not only for the ultimate limit state(4) (strength) but also for the serviceability limit state (deflections, strains and stress ranges).

In summary, the two principal objectives of the tests have been achieved;

The validation of the use of the ELFEN DE analytical method to predict serviceability behaviour in unstrengthened and strengthened arches, and,

■ The demonstration that the retrofitted anchors contribute to the structural behaviour under service loads and that these effects are beneficial and measurable.

CASE HISTORY AMERICAN BRIDGES

Award
Winning
Technology



Aldie Bridge.

The Aldie Bridge in Northern Virginia carries a significant traffic flow on State Route 50 from Washington DC to the East and the rural communities of Northern Virginia to the West. Good traffic management was an essential feature of the strengthening project and one lane always had to be available for traffic day and night with both lanes open at peak times. The twin arches were refurbished and reinforced to a loading of HS 25 and the surrounding environment was fully protected during the drilling and anchor installation process. The project was completed in 21 working days on site with minimal traffic disruption, maximum environmental protection and the preservation of the character of this important local historic structure.



Wisconsin Avenue Bridge.

The Wisconsin Avenue Bridge over the C&O Canal in Washington DC carries a major road link between busy Georgetown and the Western end of K Street above the Potomac River. The complicated area traffic management plan required one lane to be open at all times throughout the modification phase of the project and the anchor installation was completed in 18 working days. Being in the center of an area known for its restaurants and bars, the drilling operation attracted a regular crowd of on-lookers. 12 longitudinal anchors and five transverse anchors were installed to strengthen the bridge to an HS 25 loading. The bridge was strengthened and restored to its historic character as a well known landmark of Georgetown.



Century Lane Bridge.

The Century Lane Bridge is a single lane twin arch masonry bridge spanning 'Poquessing Creek', the border between City of Philadelphia and Bucks County, PA. The bridge was fully closed during the strengthening project and anchor installation could proceed without disruption of work due to traffic management considerations. Some masonry refurbishment was carried out on the spandrel walls and central pier after the longitudinal and lateral anchors had been positioned. The reinforced bridge, restored to its historic character, was handed back to the City after only 5 weeks on site, including the provision of a new deck and approach roads.



Leominster Bridge.

The Leominster Bridge, MA is a three-lane twin arch bridge carrying a large traffic volume into the center of town through busy intersections at each end of the bridge. This major reinforcement project required a sophisticated traffic management plan to ensure traffic flows were maintained throughout the drilling and anchor installation phases. The anchor installation work took 28 working days and the bridge loading was increased to HS 25. During the mobilization, the bridge was wired for load monitoring after the main contract was completed. Sensors are to be installed in the bridge and calibrated to enable the stress and loading to be continuously monitored and measured.



Newcomers Bridge.

A single arch random masonry structure, Newcomers Bridge over the Savage River was built in about 1850 and provides the only road access to a small, community to the West of Frostburg, MD. The bridge is at an altitude of over 3,000 feet and the strengthening was undertaken during a severe winter. Four large longitudinal and many lateral anchors were installed into the barrel, to bring the bridge loading up to HS 20. Considerable masonry refurbishment was needed to restore the spandrel walls and intra-dos in order to recover and enhance the character of this historic bridge.



Puente Laguna Condado.

The Puente Laguna Condado is a principal entrance to San Juan Puerto Rico. It is multiple steel girder bridge built in 1926. The marine environment had substantially weakened the bridge and as an emergency measure, steel seat brackets were installed under each beam and connected to the concrete piers. This was achieved with corrosion resistant and highly compatible cementitious Cintec anchors.



CASE HISTORY AMERICAN BRIDGES

Wisconsin Ave Bridge Washington D.C.

Strengthening from Within

by Christy Darden and Thomas J. Scott

Seamlessly integrating new and old materials helped strengthen a historic bridge in Washington, DC.



The Chesapeake & Ohio Canal flows under the stone masonry arch of the Wisconsin Avenue Bridge in the busy Georgetown area of Washington, DC. The towpath beside the canal serves as a footpath and recreation resource. The original wrought-iron railing dates back to 1831.

The twin demands of accommodating heavy traffic and ensuring the preservation of the oldest bridge in the Nation's capital proved to be manageable challenges on a recent restoration project in the historic Georgetown area of Washington, DC. When structural analyses showed that the Wisconsin Avenue Bridge over the Chesapeake and Ohio Canal National Historical Park could not adequately support current vehicle loads, transportation officials from the District Department of Transportation (DDOT) and the Eastern Federal Lands Highway Division (EFLHD) of the Federal Highway Administration (FHWA), began exploring alternatives to strengthen the structure.

Adding to the complexity of the project, the National Park Service (NPS) owns the bridge and DDOT is responsible for the maintenance and control of the road through an interagency agreement, so collaboration and cooperation became essential early on--and remained so throughout the project--to ensure that both transportation and historic preservation goals were met.

CASE HISTORY AMERICAN BRIDGES

Wisconsin Ave Bridge Washington D.C.



Mules on the towpath pull tour boats operated by the National Park Service up and down the canal.

"The strengthening project was necessary because DDOT needed to have a reliable and increased load rating for the structure," says Darcel Collins, the FHWA project engineer, "and much of the masonry and iron railing was in very poor condition and needed restoration."

An innovative reinforcing system embedded entirely within the structure offered a solution that helped the team strengthen the stone arch bridge without visibly altering the appearance of the historic structure. Careful planning kept the heavy city traffic flowing on this key thoroughfare throughout construction. An equally significant accomplishment: multiple agencies with widely diverse missions cooperated to make the project a success. Finally, public coordination and communication were critical to the project and helped immensely, even though construction caused some disruptions to the community.

A Historic Bridge Needs Help

Built in 1831, the High Street Bridge—now called the Wisconsin Avenue Bridge—lies in the heart of Georgetown, a National Historic Landmark District, just minutes from the White House. When the district was established in 1967, the bridge was identified as a contributing element. Resting in the midst of the restored historic district, office buildings, and modern condominiums, the bridge supports a busy city street used by residents, office workers, tourists, and trucks delivering seafood, vegetables, and meats to stock fashionable Georgetown restaurants.

The single-span arch bridge extends across approximately 16.5 meters (54 feet) over the canal and adjacent towpath. It is constructed of local gneiss (a foliated metamorphic rock, compositionally related to granite), most likely a byproduct of material extracted when the canal was dug, and Aquia sandstone, a building material quarried along the Potomac River during the colonial period. Aquia sandstone was used in numerous historic structures in the DC area such as the U.S. Capitol Building and White House. The original wrought iron picket railing is anchored in large capstones that adorn the top of the spandrel walls and stone wing walls. Large stone end posts topped with ornamental cast-iron spheres stand at each corner of the bridge and at the ends of the railings above the wing walls.

The canal and adjacent towpath historically served as the transportation corridor that carried coal-laden boats, with the aid of mules, into Washington, DC. Today, the towpath under the bridge is a popular resource for pedestrians traversing through the busy office and commercial district and lures recreational hiking, jogging, and bicycling enthusiasts as well. In addition, NPS uses the path to educate new generations through tour boat rides that offer a glimpse into the past, when it was a common sight to see mules towing boats along the canal. Therefore, keeping the path safely open for foot and diverse recreational traffic was an important consideration during the project planning.

CASE HISTORY AMERICAN BRIDGES

Wisconsin Ave Bridge Washington D.C.

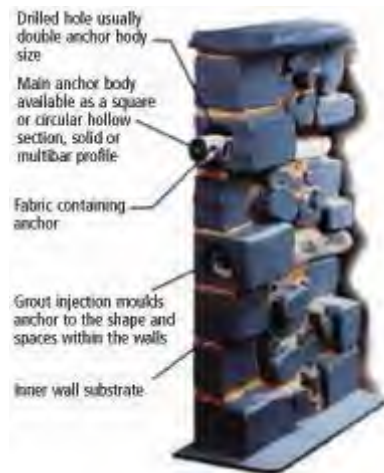

Source: Cintec.

This cutaway model of the Archtec process illustrates how a stainless steel reinforcing rod fits into a slightly permeable fabric sock that is then filled with cementitious grout under pressure.

The bridge was originally designed to carry horse-and-cart trade across the canal. Today the structure carries the heavy loads of a modern urban bridge—9,400 vehicles per day on average. Although the bridge was not "overtly" structurally deficient, its load rating could not be determined accurately. Therefore, in the mid-1990s, the help of a consulting engineering firm was sought to assess the situation.

After an inspection and load rating analysis, the engineering firm determined that the bridge could not support current vehicle loads at the minimum live load of HS20 recommended by the American Association of State Highway and Transportation Officials (AASHTO), which is 32.7 metric tons (36 tons). DDOT asked the engineering firm to investigate alternatives for strengthening the bridge. In 1999, the department sought assistance from FHWA to complete the project, along with several others in the area, and EFLHD entered into a memorandum of agreement with DDOT.

High Expectations

At the beginning, one of the first challenges was to agree on the scope and purpose of the project. Each stakeholder had a different mission, and dozens of meetings were required to work out the compromises and concessions that eventually satisfied the participants.

As owner, NPS initially was reluctant to allow work to be done on the historic structure, and the agency wanted reasonable assurance that the strengthening project was not overdesigning a solution that might compromise the historic integrity of the oldest bridge in Washington, DC. "Our mission is to preserve historic structures as nearly as possible to the original state," says Mike Seibert, exhibits specialist (restoration) and preservation project manager with NPS.

The National Historic Preservation Act of 1966 defines the National Park Service's stewardship of cultural resources within the national parks. The essence of the mandate is to retain the most historic fabric possible and not implement treatments that could damage or adversely affect historic materials. "This includes not using modern materials with old materials without adequate research as to the effect on the

CASE HISTORY AMERICAN BRIDGES

Wisconsin Ave Bridge Washington D.C.

cultural resource," Seibert adds. "As preservation professionals, we would seek other alternatives, such as rerouting traffic, before altering the bridge." The capability to carry heavy truckloads on this bridge would turn out to be a big challenge for designers to accommodate.

As the design team—including DDOT, EFLHD, NPS, and their contractors—began to prepare for the project, it also solicited feedback on traffic control choices from the community. Through meetings with Georgetown's various community groups, hotels, restaurants, and other businesses in the corridor, the team learned that the major concerns centered on minimizing the impacts on traffic in the small, already congested area.

A Solution Presents Itself

In April 2001, EFLHD, DDOT, and NPS began exploring possible methods for strengthening and preserving the bridge. Because masonry arch bridges were commonly removed and replaced with modern concrete or steel structures, relatively few stone masonry arch bridges remain in the United States, and very few comparable bridge strengthening projects exist. One method for strengthening would be to build a new, load-bearing bridge over the top of the original bridge, a method called saddling. Neither demolition nor saddling was appropriate given the physical and spatial constraints of the site and the desire to preserve and protect the existing historic structure.

While researching alternative solutions, the team learned about a stone masonry strengthening process that preserves the original structure. The company that developed the process, based in Great Britain, had been involved in a project to restore a multispan bridge in Aldie, VA.

The process, called Archtec™, involves installing a reinforcing system entirely within the fabric of the structure, leaving no visible change to the outward appearance. According to the British company that owns the process, the concept was originally developed in Germany and has evolved to meet the diverse requirements of the civil engineering industry in the fields of strengthening and preservation. In fact, some 70 bridges have been upgraded using this strengthening system in the United States, Australia, and Europe. In addition, the technology has been used in Windsor Castle, Buckingham Palace, the Blair House (part of the White House complex in Washington, DC), and other buildings.



The masonry grout is strained to remove lumps before it is fed into the fabric sleeve.

The system combines simulation software and a reinforcing process. Full-scale arch mockups of a bridge are created and load-tested to failure in the software. To develop a specific treatment, a designer then

CASE HISTORY AMERICAN BRIDGES

Wisconsin Ave Bridge Washington D.C.

creates a three-dimensional model of a bridge using a computer-aided design (CAD) program. Live loads are then simulated as the bridge model is progressively strengthened. When the simulated reinforcement is in line with the live loading required for the project, the software generates the final design specification.

A representative from the manufacturer describes the reinforcing process as follows. First, holes are drilled into the arch barrel through the road surface using diamond core drills. The drill rod is left in the hole and a stainless steel reinforcement bar, surrounded by a woven polyester sleeve, is then inserted inside the rod. The drill rod is then removed and grout is pumped under low pressure into the sleeve. The sleeve inflates from the bottom up to prevent trapping air bubbles and expands into the profile of the hole, forming a chemical and mechanical bond between the reinforcing bar and the substrate. The sleeve is permeable enough to allow some of the grout milk to seep through to form the mechanical bond, but not so permeable that the grout escapes into cavities in the infill, which potentially could damage the arch. When the process is complete, the only visible evidence of the drilling is a small amount of grout on the surface, which later will be covered during repaving. In other words, the system works by grouting a deformed stainless steel reinforcing rod into holes drilled into the arch. This adds internal reinforcement to the arch bridge so that it acts as a reinforced cohesive unit.

One of the factors that influenced the selection of the strengthening method was that U.S. design specifications did not provide extensive guidance on load rating masonry arch bridges. However, the United Kingdom Highways Agency has developed comprehensive standards for assessing live load capacity on masonry bridges. The standards are incorporated into the agency's *Design Manual for Roads and Bridges: Volume 3, Section 4, Part 3, BD 21/01, "The Assessment of Highway Bridges and Structures."* (For more information, see www.official-documents.co.uk/document/deps/ha/dmrb/vol3/section4.htm.)

The company that owns the strengthening process helped develop the U.K. standards that are now widely accepted throughout the world as the most comprehensive code for assessing masonry arches. With its proprietary software, the company completed a finite element analysis of the structure to approximate the bridge's live load capacity rating and create models to determine the point of failure. Another benefit of using this system is that the entire drilling, coring, and installation operation can take place on the existing roadway surface, without requiring excavation. Utilities do not need to be relocated or otherwise affected during construction.

In addition, the strengthening system takes substantially less time than traditional methods like saddling, and its effect on traffic is minimal. According to the manufacturer, the installed reinforcing rods have been independently age-tested in the United States and Europe, with a predicted long-term durability of at least 120 years.

Design and Construction

A detailed survey of the bridge focused on the road and arch barrel surfaces, and control points were established for setting up the drilling rig during operations. Engineers visually inspected the arch intrados (interior curve of the arch), spandrel and wing walls, and the railings to assess the general condition of the bridge, and took core samples.

Then the designers modeled the properties of the materials and the behavior of the material contacts, and applied loading in accordance with the British standard. Next, they loaded the survey data into the program to generate a three-dimensional CAD model including the road and arch barrel surfaces, the position and length of the reinforcing rods, the angles of insertion, and utilities.

After establishing the optimum design, construction began in September 2004. Workers drilled holes 6.5 centimeters (2.56 inches) in diameter parallel to the roadway and at an angle along the arch. The holes were drilled to the precise angles specified in the design with a small core drill, which operated at a slow enough speed to preclude any potential damage to the structure due to vibration. The drill rig was bolted

CASE HISTORY AMERICAN BRIDGES

Wisconsin Ave Bridge Washington D.C.

to the road through the paving surface to prevent movement during drilling. After a hole was drilled, the reinforcing rod and fabric sleeve were inserted into the hole, and the drilling rig was then moved to begin the next hole. In all, 26 reinforcing rods (13 on each side of the arch crown) were then inserted into the arch barrel. With two drilling rigs, workers were able to drill two holes a day.

"We had not seen the technology before," says Karyn LeBlanc, communications specialist with DDOT. "This was really an interesting engineering feat. We took other engineers out to view the process as it was going on because it was so innovative."

In the end, workers were able to strengthen the Wisconsin Avenue Bridge in less than 3 weeks—2 days ahead of schedule. The strengthening process cost about \$350,000 (construction) plus design. Replacement, which was out of the question because of the historic value of the bridge, would have cost many times that, with greater disruption to the local community and traffic.

Additional improvements planned for 2005 include a new concrete slab over the arch to function as a riding surface, and the restoration of the iron railings, stone work, and sidewalks, further enhancing the safety and beauty of the bridge.

A Smooth Operation

The experiences on the Wisconsin Avenue Bridge project yielded several significant lessons for future projects. First, the innovative strengthening process could be a viable option for dealing with other historic structures and can be considered when addressing the requirements of historic preservation, while also satisfying modern engineering, safety, and environmental requirements. Before the strengthening project, the weight restriction on the bridge was posted at 22.7 metric tons (25 tons), according to an inspection report from February 1997. After the renovation, the rating is HS25, or 40.8 metric tons (45 tons) under AASHTO guidelines.

The project not only improved the safety of the 174-year-old structure but also extended its service life. Traffic continued to utilize the bridge throughout the duration of construction with minimal disruption. Northbound traffic continued to use one lane throughout the process, while southbound traffic was rerouted to a street one block away.



Workers bolt the drilling rig to the pavement on the bridge in preparation for drilling the 26 holes needed for the strengthening project.

CASE HISTORY AMERICAN BRIDGES

Wisconsin Ave Bridge Washington D.C.



Workers insert the fabric sleeve and stainless steel reinforcing rod into the drilling pipe, which is later removed. In the background, traffic continues to move across the bridge during the work.

Cooperation and communication among multiple stakeholders during the planning and design stages through project completion helped resolve issues before they became problems. Meetings were the preferred method to identify and work through concerns, and FHWA coordinated the meetings to ensure that appropriate decisionmakers were present. Tony Fusco of KCI Technologies, design consultant on the project, describes the process: "We basically began by laying out the design criteria and the level to which we would strengthen the bridge, presenting the pros and cons of each alternative. This established the surface features of the bridge as an extremely important priority to the National Park Service and helped us identify acceptable rehabilitation treatments that would not compromise the structure's purpose or historic character but would minimize or eliminate the cause for the exhibited failure mode."

Once all the concerns were identified, rehabilitation designs could be developed to address each concern and element of the bridge. Each agency played a role in the review during the design phase to ensure that their concerns were being addressed adequately. "If additional concerns were identified during any phase of the design, we would address them and incorporate the solutions into the design for all to consider at the next review stage," Fusco says. "If there were critical elements of the design that could derail or delay the design process, we would make specific interim submissions addressing the concern to the respective agency to gain feedback and agreement before proceeding with the next project review submission. Conducting meetings face to face enabled us to present engineering construction documents and data to nonengineers reviewing the information and provided them the opportunity to question us, so they had a full understanding of the project, details, materials, and intended outcome."

CASE HISTORY AMERICAN BRIDGES

Wisconsin Ave Bridge Washington D.C.



Mike Seibert, NPS

Historic meets modern. Today, the old Wisconsin Avenue Bridge, shown here looking north up busy Wisconsin Avenue, continues to support a variety of traffic ranging from pedestrians and bicyclists to cars and heavy trucks.

According to DDOT's LeBlanc, involving personnel from all relevant government agencies as well as citizen groups and businesses was key. "Communicate, communicate, communicate," she says. "We sought [community] input, and we worked to come up with a solution acceptable to all the parties involved—the businesses, the taxpayers, and the citizens."

The iterative meetings and frequent communication were well worth the lengthy upfront planning. "It made the actual construction go smoothly and quickly," Fusco adds. "We encountered no surprises, and all participants felt satisfied that their particular requirements were being met. The extensive planning

prevented work interruption by clarifying concerns and negotiating concessions to achieve win-win solutions."

In the end, what began as a potentially contentious aspect of the project—addressing the diverse concerns of multiple stakeholders—turned into one of the most rewarding, according to Mike Seibert of NPS. "We came together skeptical of the other participants' intentions, but before the project concluded,

CASE HISTORY AMERICAN BRIDGES

Wisconsin Ave Bridge Washington D.C.

we were working together as a team, with respect for each other's needs," he says. "Really, we will miss working together."

Christy Darden is a project manager for EFLHD in Sterling, VA. She leads a team of engineers and specialists who provide transportation engineering services to Federal land managing agencies on projects that improve highway safety, incorporate new technology, and meet restrictions in sensitive environments. She earned a bachelor of civil engineering degree from Georgia Institute of Technology, and she is working on her master of public administration degree.

Thomas J. Scott is a construction operations engineer for EFLHD in Sterling, VA. He oversees a staff of engineers and technicians on several construction projects for DDOT, NPS, and the U.S. Fish and Wildlife Service. Previously, Scott was a project engineer on EFLHD construction projects on the Baltimore-Washington Parkway. He earned a bachelor of science degree in civil engineering from North Carolina State University and is a registered professional engineer in Virginia.

For more information, contact Thomas J. Scott at 703-404-6270.

CASE HISTORY

Red Bridge- Campbell Town, Tasmania, Australia



View from the west



Centre Span



Damage to wingfall – note coloured cement render from 1930's and salt deposition caused by it.

The “Red Bridge” across the Elizabeth River at Campbell Town in Tasmania is the oldest surviving brick arch bridge in Australia. It consists of three segmental arch spans of 7.6 meters (25 feet) and was built by convict labor between 1836 and 1838 using red clay bricks made on site (hence its name). It rests on a basalt stone substructure and uses sandstone for the piers, abutments and capping.

The bridge was originally built wide enough to take two modern traffic lanes, plus footways, and lies on the main highway between the Tasmanian capital of Hobart and the principle northern city of Launceston. There is presently no convenient alternative route, nor is one planned in the near future. The Tasmanian Department of infrastructure, Energy and Resources, which control the bridge, required a contractor to take responsibility for the design and construction of rehabilitation and strengthening works to restore the original structure integrity of the bridge and strengthen it to take modern heavy vehicles, which are presently up to 62.5 tones on 9 axles in the “B-Double” configuration. Part of the “wish list” also required strengthening to the new SM1600 loading which allows for future increases and has loads in excess of 36 tones on a 3 axle group. An alliance was formed by Cintec Australasia with Van Ek Contracting of Tasmania, a firm known for its expertise in conservation of old bridges and buildings of new ones. When expressions of interest were called from all over Australia for a design and construct contract, only the Cintec alliance using the Archtec process was able to satisfy the Department and a contract was negotiated without further tendering.

Analysis by the Archtec consultants, Gifford and partners of England, showed that the bridge could be strengthened to the required SM1600 Loading. The project required 54-30mm diam. X 5m long anchors which were installed in late April to early May, 2000

Expertise from within the world wide Cintec organization was also utilized in conserving the masonry which required cleaning, reappointing and grouting. Bill Jordan, who heads Cintec Australia, advised on the masonry conservation in his capacity as a consulting Structural Engineer specializing in conservation, with the help of peter Sobek, the Cintec grout expert from Germany. Specially formulated lime grouts and mortars were used to ensure that the bridge meets the requirements of 100 years future life without major repairs.

Pont Telpyn Bridge



CASE HISTORY

HOW CINTEC SAVED A MASONRY ARCH BRIDGE FROM THE FLOODS

Pont Telpyn Bridge

Pont Telpyn bridge links the A525 at Rhewl with the B5429 and crosses the river Clywd. In 2008 during strengthening works the bridge suffered severe flood damage and was very near complete collapse, the only saving grace was that Cintec Archtec anchors were in the process of being installed, the installed anchors prevented the complete collapse of the bridge.



The east abutment appeared to be intact with no movement or cracking identified. The west abutment appeared to be intact at the upstream elevation. At the downstream elevation there was a large amount of dilatency of the masonry, with severe cracking and evidence of movement on both faces.



The movement of the road surface suggested that the arch barrel had rotated up to 4.5 degrees about the east springing. There was distortion of the arch barrel due to differential movement, resulting in a shear crack at the west upstream corner. The fact that this corner is lower than the adjacent arch barrel suggested that the abutment dropped vertically at this corner, followed by the adjacent arch barrel. Apart from this south west corner, the arch barrel was in reasonable condition.



The damage to the upstream spandrel and parapet was mainly limited to the large area of damage above the west abutment and a significant crack above the east abutment. Damage to the downstream spandrel and parapet was more widespread, with cracking through mortar joints almost throughout the length of the wall.

The road surface showed three main failures, indicating tension failure above the east abutment, compression failure above the west springing and shear failure to the west of the bridge.

CASE HISTORY

HOW CINTEC SAVED A MASONRY ARCH BRIDGE FROM THE FLOODS

Pont Telpyn Bridge

A temporary channel was excavated, lined with gabions and stones to divert the river throughout the repair phase.



Cintec anchors were drilled and installed to stabilise the structure.



The arch was propped underneath and the parapet walls removed.

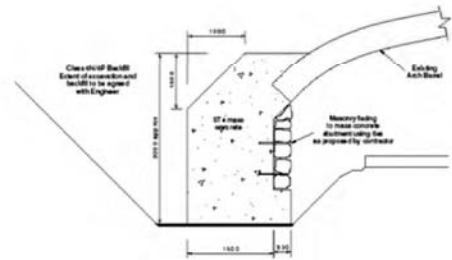
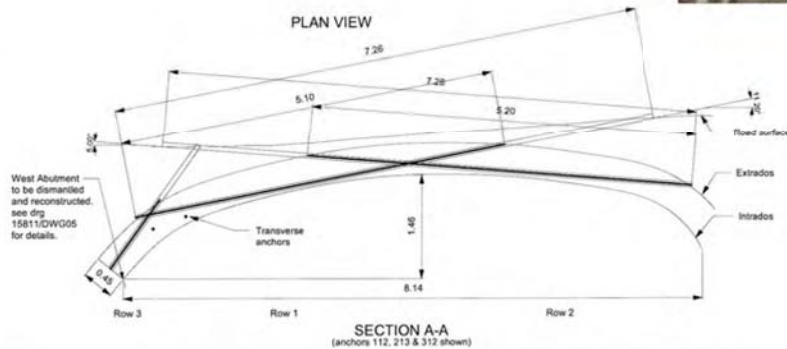

<p>PROJECT PONT TELPYN 1 BRIDGE ARCH STABILISATION</p> <p>ARCHTEC</p> <p>CINTEC International Limited (UK) Cintec House, 11 Goldtops Newport NP23 4PH Tel: 01633 246614</p>	<p>Gifford</p> <p>www.gifford.co.uk info@gifford.co.uk</p> <p>Roman House, The Valley Business Park, Rushey Road, South Ruislip, B321 3AB Tel: 023 80149000 Fax: 023 8011 8600</p>
--	---

CASE HISTORY

HOW CINTEC SAVED A MASONRY ARCH BRIDGE FROM THE FLOODS

Pont Telpyn Bridge

New foundations cast in concrete and new training walls built.



After the installation of the Cintec anchors to bring the bridge back to a 40 tonne capacity, the roadway was reconstructed to the original profile.



New culvert installed to act as a permanent flood relief system which was put to the test shortly after the project was completed.



The flood had caused the abutment to move which necessitated the complete removal of the abutment and providing a new foundation and concrete abutment, which was subsequently faced with stone.



New gabions were placed to protect the river bank and training walls constructed, faced with stone to match the structure.



Parapet walls rebuilt and all fencing, landscaping, river banks and hedges were reinstated.

CASE HISTORY

Clifton Suspension Bridge

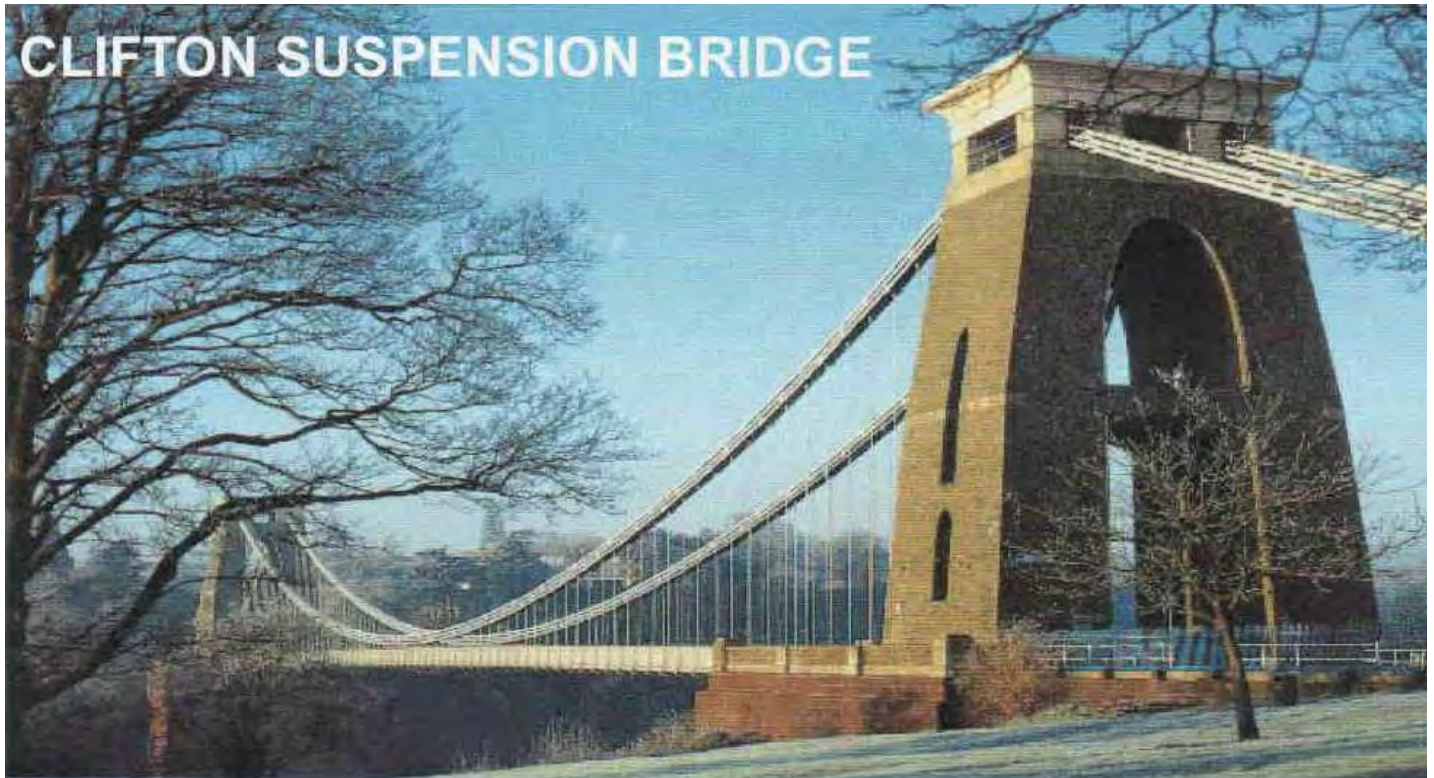

The Clifton Suspension Bridge is a grade 1 listed structure. It was designed by Isambard Kingdom Brunel and spans 214m (234 yards) from tower to tower across the Avon Gorge. Opened in 1864 it remains a testament to 19th Century engineering. Previously thought to be solid, in 2002, an electronic survey of the sandstone abutment supporting the 26m (28.5 yards) high tower provided evidence of 12 vaulted chambers. Arranged in two tiers- they are interlinked by narrow tunnels and shafts just 0.6m in diameter. The purpose of the chambers is unclear. However, with each chamber measuring on average 11m (12 yards) high by 15m (16.4 yards) long- they would have offered a considerable saving in material. In order to gain a discreet access to these chambers and after engineering surveys confirmed that the abutment was structurally safe, work began on forming a permanent door for maintenance access.

An exploratory core found the walls to be solid with an overall thickness of 1,800mm (70"). It comprises two sandstone skins with lime mortar in between.

In spring 2003, work commenced to form a doorway 12m (13 yards) below the level of the footway, approximately half way down the abutment where the wall returns to tie into the side of the gorge. The work began with the stitch drilling of 70 holes to a length of 1,800 mm (70") each with a diameter of 102mm (4") in order to create an opening approximately 2,000mm (79") high by 830mm (33") wide.

CASE HISTORY

Following this, 20 CINTEC stainless steel rebar anchors were used to pin together the external and internal sandstone blocks cut through by the opening. These 16mm (5/8") diameter solid circular section anchors, measuring 1,500mm (59") long, were installed at an angle and at 300mm centers around the doorway. The anchors were inserted in 40mm (1 1/2") diameter predrilled holes, oversized to accommodate expansion of the anchor sleeve with grout. In order to maintain the aesthetics of the bridge the anchors were in set by 200mm (8") to ensure they would not be visible on the external sandstone face, achieving a sympathetic invisible bond around the new opening in the listed structure. Falcon Structural Repairs of Portishead – UK, undertook the stitch drilling and anchoring to create the new doorway, it required eight days to cut the opening and just two days to install the CINJTEC anchors. The work was approved by English Heritage as well as the local planning authorities.

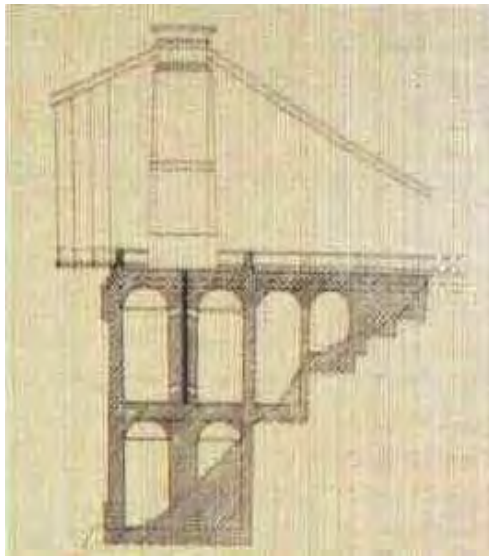

CASE HISTORY

BODIAM BRIDGE, ENGLAND, U.K.



Introduction

The Highways and Transportation Department of East Sussex County Council is responsible for the maintenance of the 200 year old brickwork arch bridge adjacent to Bodiam Castle. In recent years this has suffered from the effects of increasingly heavy traffic exacerbated by very cold winters in 1986 and 1987. This led to cracking of brickwork adjacent to the arch voussoirs, some movement in the spandrel walls and delamination of the wing walls at the south end. The County Council approached Cintec International with a view to using Cintec anchors for tying across the arch.

History

The crossing of the river Rother at Bodiam, midway between Tunbridge Wells and Hastings, has a long history. The site is that of a Roman road, constructed on a twigs and rubble causeway to serve an ironworks. Until the 13th century the surrounding alluvial plain was under a shallow depth of brackish water as much as 420m wide, and for some time crossed by a ferry. The first reference to a bridge on the site is in 1385, and the present bridge was built in 1797 for the County of Sussex by Richard Louch for £1150.

The bridge is a single track, hump-backed triple arch structure in brickwork and there are signs of various



Typical damage to the soffit of the bridge

remedial works throughout its life. There appear to have been problems with the original construction for there is pronounced twist in the lower courses of brickwork towards the northern end of the bridge, which disappears as the construction continues upward. Presumably this was due to some of the timber piling settling during construction. The cast-iron end bosses of previous ties between the spandrel walls can be seen on both elevations. In 1980 an inspection carried out by divers revealed that the timber piles on which the bridge is founded had become exposed and were deteriorating. In 1982 a concrete filled Fabriform mattress was installed to provide a solid invert and protect the foundations of the bridge. Also in 1982 the approach ramps to the bridge were filled by up to 200mm to minimise the hump. A principal inspection and assessment in 1989 concluded that remedial works to the arch rings and a weight limit of 17 tonnes were required to prevent further deterioration. This weight limit remains in force after the remedial works have been completed to preserve the bridge but will still allow coaches over to visit the adjacent Bodiam Castle, a National Trust property.

The most recent remedial work involved the repair of cracking in the brickwork. The concentration of the damage in the two side spans of the three span bridge suggested that the initial cause was possibly impact loading towards the ends of the bridge before the 'hump' was levelled out in 1982. This impact loading will have had the effect of forcing out the spandrel walls. Frost damage during the cold winters of 1936 and 1987 and washing out of mortar have further developed the initial effects. This has led to cracking of brickwork adjacent to the arch voussoirs, some movement in the spandrel walls, and delamination of the wing walls at the south end.

In view of the historical context of this attractive small bridge, East Sussex County Council was concerned to find an effective means of tying, with 11 minimum visual impact, across the arches, within the thickness of the arch brickwork, Cintec anchors offered the possibility of bonding along the full length of the anchor without an

CASE HISTORY

unsightly external anchorage or problems with grout losses through the cracks in the arch.

The use of Cintec anchors for Bodiam bridge gives a number of major advantages over conventional cement



Placing the anchor in the prepared hole

or resin grouted anchors. Conventional grouted anchor systems can have problems in the grouting, and there are doubts about the effectiveness of the anchors, when large volumes of grout are lost into voids within the structure, or escape through cracks. Bodiam bridge, with its cracking and deteriorating joints, provides a good example of the potential problems. But in the case of Cintec anchors the sleeve limits the travel of the grout and ensures that the holes are filled and effectively bonded to the parent material. This capacity to constrain the grout can be used to tailor the anchor to the material in which it is to be placed. For maximum bond in weak or voided materials, a generous sized sleeve of relatively flexible composition can be used with lower grout pressures. In stronger and more homogeneous parent material, a smaller diameter and stiffer sleeve allows higher grout pressures for longer anchor lengths, more economy in grout use and probably greater direct bond. With conventional anchor systems the gap between the tension element and the inner face of the drill hole has to be kept to a minimum to ensure that the hole is completely filled. With a Cintec anchor the diameter of the drill hole is normally between two and three times the nominal size of the structural section (and could be still greater) giving a much larger bond area. This is particularly beneficial in weak materials where the low bond stresses combined with the bonding agent maximise the anchorage into the parent material.

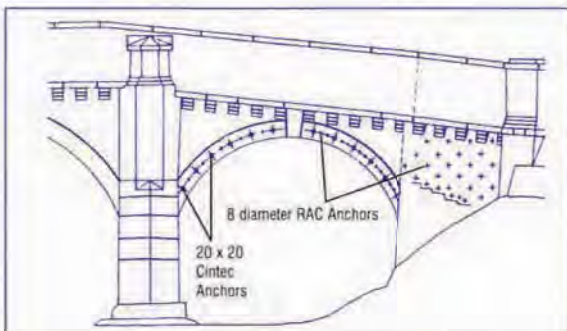

Part elevation of the bridge and abutment showing anchor locations

With this flexibility it is possible to use the Cintec system for lengths in excess of five metres, several times the limiting length for some similar systems. The length capability is also a result of using structural hollow sections which can double as the grout tube. This guarantees grout injection at the bottom of the hole without grout tubes and gives confidence that the sleeve is effectively filled. Since the anchors are bonded throughout their length it is quite feasible to stop them behind the exposed face and make good the drill hole with coloured mortar or a slip taken from one of the cores.

The solution

To prevent any further spreading of the arches it was proposed to tie across the full width of the bridge. The main anchors are 20 x 20 x 2.0 SHS with the lengths, of 2.0m and 1.0m, staggered from both sides of the bridge. This ensures that the lateral stresses are not transferred to a single plane nearer the centre-line of the bridge causing new cracking at this point. Strengthening of the local edge damage to the brickwork of the arches is achieved with the installation of 450mm long RAC anchors formed with 8 x 1.5mm circular hollow sections. The interspacing of the two anchors allowed the 20mm diameter holes for the small anchors to be used for the fixing of the stand used with the diamond drilling of the 52mm holes for the main anchors, thus keeping the making good to a minimum. Following grouting of the anchors the holes were made good with coloured mortar to match the brickwork.

The smaller anchors were also used for repair of the southern wing walls where core drilling of bulged portions of the wall showed that a half brick facing skin was delaminating from the full 600mm thickness of the wall. The high bond capacity meant that an effective anchorage into a single half-brick skin could be achieved while still having the end of the anchor recessed into the face. Once this skin had been tied back the cavity was grouted to stabilise the bulged area.

To complete all the repair work the cracks were surface sealed and grouted with resinous or cementitious grout depending on their width. Brickwork was re-pointed and repaired where this was essential, but this was kept to a minimum because of the difficulty of matching the existing finishes.

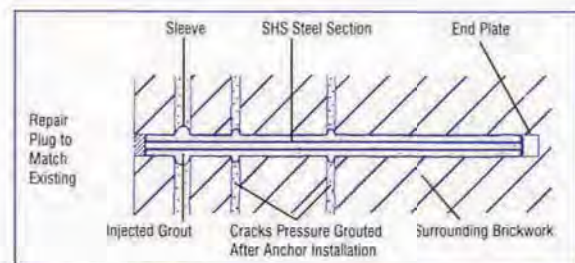

Section through a typical Cintec anchor installation

CASE HISTORY

Snowbridge Glasgow, Scotland, U.K.



Hidden in the tranquil gardens of Kelvin Grove Park Glasgow, Scotland. The Snowbridge was thought by many to have gracefully retired into obscurity. Its past glory of being the main means of disposing of the accumulated snow from the entire main thoroughfares of Glasgow had been superseded decades before by mechanical loaders.

With its retirement, it suffered like most obsolete structures with neglect and lack of maintenance due to the low priority it rated in the financial bids.

In 1987, Cintec was asked to provide an estimate to rectify the many years of neglect. Following a complete survey and report from Engineers Ove Arup and Partners, a comprehensive maintenance and anchoring scheme was presented to the City Council to bring the structure to a safe condition.

The scheme principally provided for the introduction of square hollow section stainless steel anchors size 30x30x3, 20x20x2, 15x15x1.5 in lengths from 500mm to 5000mm to the voussoirs and intrados of the arches and spandrel walls. The drilling chosen was wet diamond drilling with core retention to the natural stone structure. This provided the desired drilling accuracy and the need to reduce the vibration to a minimum in the fragile structure.

The proposals were kept in abeyance for several years before work commenced. Indeed, serious consideration was given to demolish the whole structure until it was found to contain optical telecommunications between the UK and the U.S.A.



CASE HISTORY

WORCESTER VIADUCT

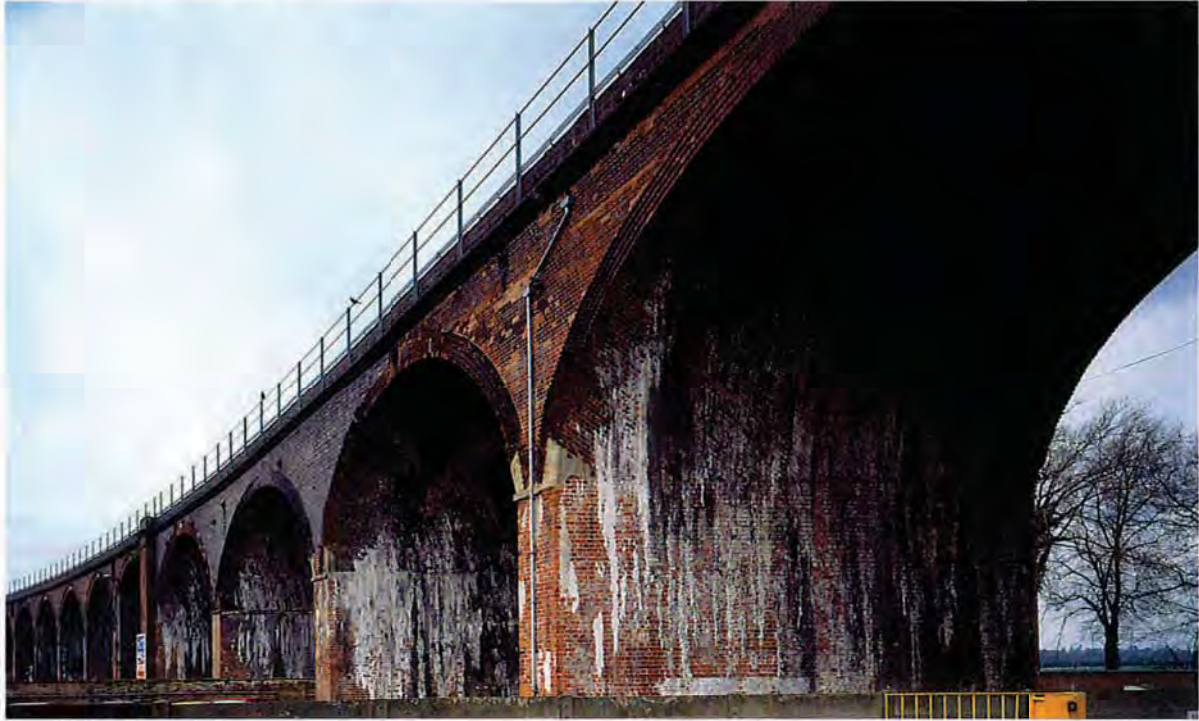

Worcester Viaduct comprises sixty-five brickwork arches rising from approximately two storey height near the railway station to over three storey height as it approaches the river. Lack of proper draining within the arch had led to the spandrel walls being forced away from the intrados arch with longitudinal cracks close to the longitudinal edges of the bridge. Water penetration had contributed to cracking at the springings of some spans and delamination of external parts of some columns. These problems had been exacerbated by weathering, particularly freezing and thawing. Previous efforts to restore the structural integrity were evident, but had proved ineffective.

Transverse 30 x 30 x 3 SHS stainless steel WSA anchors were installed to restore the integrity of the spandrel wall/intrados arch connection at approximately 750mm centre-to-centre and alternate lengths of 2.0m and 2.5m. Stitching anchors were angled across the longitudinal cracks to restore structural integrity and the cracks were then filled. Transverse and diagonal stitching anchors, type RWT, 15 x 15 x 1.5 SHS stainless steel, were installed to restore the strength of the delaminated columns and the cracks filled. Drainage holes were drilled through the intrados and plastic pipes were installed to help relieve the existing water pressure. To date five spans have been renovated using the Cintec system and further spans will be renovated as part of an ongoing maintenance programme.

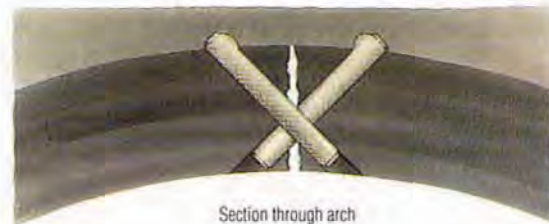

Section through arch



Plan view of stitching anchors

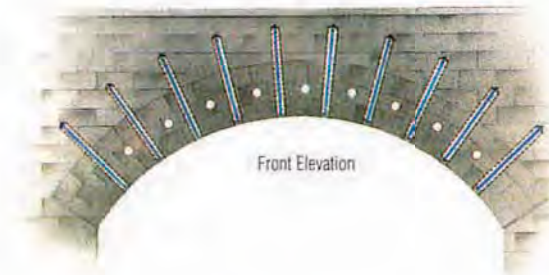

Front Elevation

CASE HISTORY

ROYAL BORDER BRIDGE, ENGLAND, U.K.



Royal Border Bridge, carrying London -Edinburgh mainline train. Photo : Mel Holley ©

As part of Railtrack's major programme of repair and refurbishment of the land-based arches, work was authorised on numbers 1–15 of the Royal Border Railway Bridge. The bridge carries the main Inter-City East Coast rail line between Edinburgh (Waverley Street) and London (King's Cross). George Stephenson's magnificent 28-arch, 128 feet high viaduct spans the tidal estuary of the River Tweed between Berwick and Tweedmouth, two and a half miles south of the Anglo-Scottish border. Queen Victoria and Prince Albert opened the 2160 feet long bridge in 1850: the structure will celebrate its 150th Anniversary at the Millennium. The project was complicated by both environmental and technical factors.

Green nylon based Debris-Mesh surrounded the main work areas to contain dust and debris from the drilling which, if uncontained, would cause environmental problems to the residents of the 36-house Riverdene Estate lying directly below the bridge. The covering material also provided a degree of shelter from the strong prevailing winds which blow eastwards down



the Tweed River valley. Furthermore, certain areas of the 61' 6" span brick arches provided roosting areas for galleries of bats and, because they are a "protected species", provision had to be made to keep their exits clear with minimum disturbance to the bats' areas. The ornamental stone-work which forms the top parapet of the viaduct, is also a nesting site for House Martins; also, in 1996 a pair of Kestrels were observed nesting under one of the electricity catenary poles.

CASE HISTORY

ROYAL BORDER BRIDGE, ENGLAND, U.K.



ANCHOR DESIGN



About 60 men were employed on the repair work and, to minimise the noise associated with work on a scaffolded structure, drilling and the movement of heavy vehicles delivering materials, the contractors were obliged to limit their work to between 8 am and 5 pm.

The project required the installation of 1256 Cintec anchors spread over 15 arches; the project was carried out during 1995 and 1996. The first stage dealt with the northern based arches which cross the River near Berwick Railway Station which is built on the site of the old castle. To enable the second stage of the repairs, an intricate network of scaffolding supported wooden staging boards from ground level to the top of the bridge (126 feet). The size of the undertaking can be gauged by the amount of steel scaffolding tubes required which, if laid end to end, would cover 65 miles.

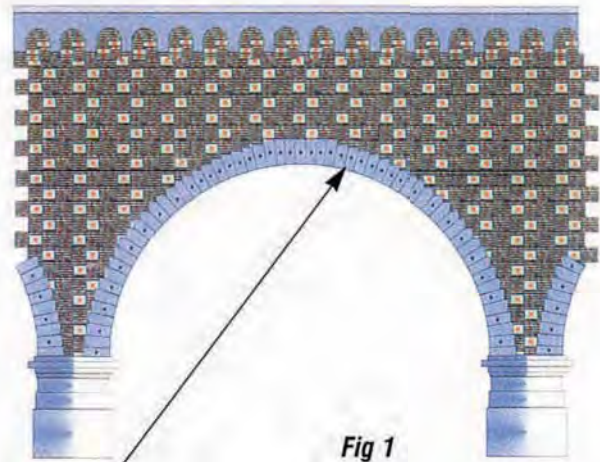

The Cintec anchors (see figs 1 & 2) were installed horizontally through the voussoirs to varying sizes and drilled depth in order to prevent the problem of creating a shear line in the parent material.

The project was partly funded by English Heritage. Apart from the erection of the electrification gantries and cables on the high-speed 125 Inter-City expresses some years earlier, this refurbishment is the first major repair work to be carried out to the Royal Border Bridge for over nearly 150 years – a tribute to the engineering skills of the Victorian builders and also an indication of the faith now placed in the Cintec Anchor System.

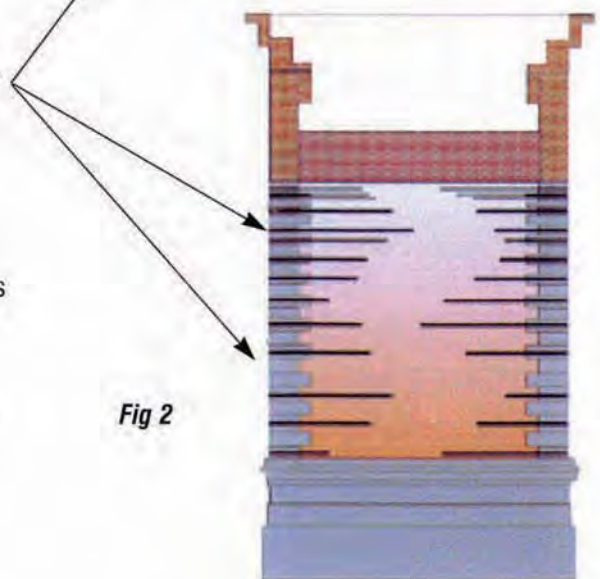

CASE HISTORY

Teviot Viaduct Roxburgh U.K.



Built in 1847, the Teviot Viaduct spans the river Teviot at Roxburgh in the Scottish Borders. As a consequence of no longer being part of the rail system, the stone masonry structure had fallen into disrepair with extensive cracking to both the arches and the piers. A number of stone blocks had also come loose and were missing. However because of its significance to local heritage, the viaduct was considered worthy of preservation and funding was made available by the British Railways Board and the Railway Heritage Trust.

The first phase of restoration involved the replacement of broken and missing voussoir stones from the arch barrels. In order to reduce the risk of a progressive collapse, neighbouring stones were held in position by square hollow section stitching anchors 4'6" in length, this consolidated the arch while the replacement stones were installed.

The second phase of work involved interlocking the outer masonry walls of each pier. The original design drawings and the photograph (below and right) reveal the extent of the cracking and the subsequent Cintec solution. In total 112 anchors were installed.

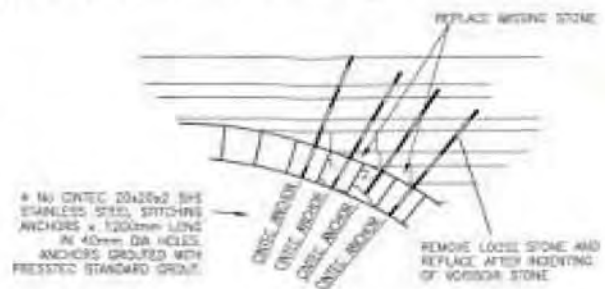

PART ELEVATION OF VOUSSOIRS/SPANDEL FACE

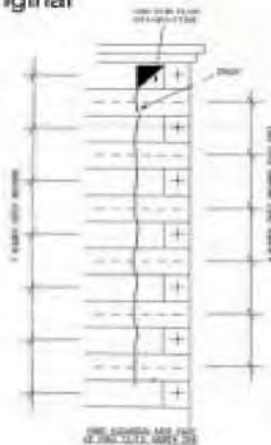
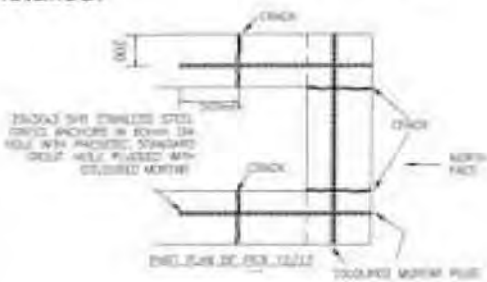

During this project a new team of installers were trained on site by an experienced Cintec Technical Advisor.



"Key hole Surgery for Bridges"

CASE HISTORY

Outwood Viaduct Radcliffe, UK

Following its closure in 1966, Outwood Viaduct had fallen into dereliction, however its proposed demolition by British Rail was forestalled due to public objection led by the Railway Heritage Trust and it was eventually given Grade II listed status.

It spans the river Irwell at the western edge of Radcliffe, Greater Manchester, the spans were fabricated and erected in 1881 and have an overall length of 336 Ft. Each span comprises of six cast iron open spandrel arch ribs with lateral bracing.

British Rail previously attempted to strengthen the four tapering brickwork pillars by adding new masonry to the original single archway piercing located in each pier. This new work had however begun to detach from the original structure and extensive cracking was visible between the new and old (see right).

Cintec supplied 108 stud and rebar stitching anchor ranging from 2.5ft to 30ft in length. These were installed through the cracks to re-connect the inner reinforcement brickwork to the original structure as indicated in the design proposal below.

After renovation, Outwood Viaduct was formally opened as a footpath, bridleway and cycle way in 1999 by Sir William McAlpine, President of the Railway Heritage Trust.

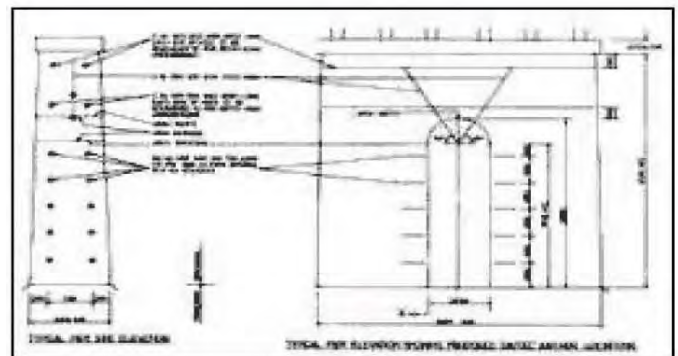
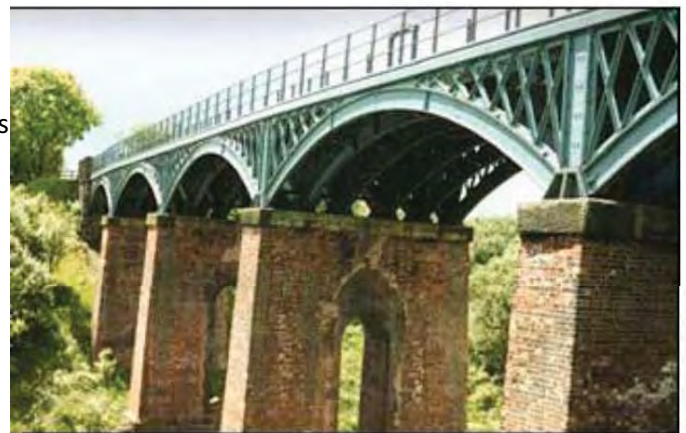
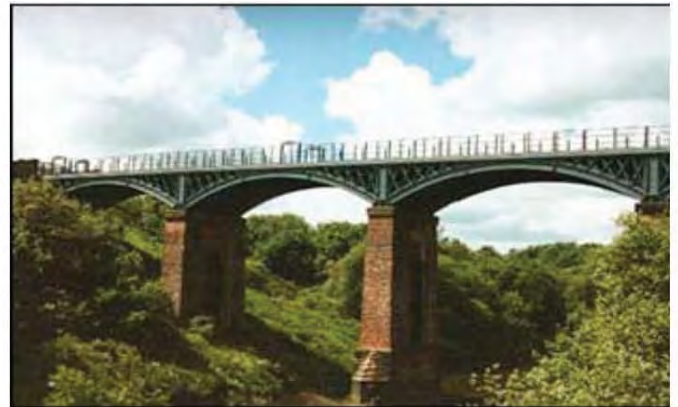

CASE HISTORY

Leaderfoot Viaduct Scottish Borders U.K.



View of drilling platform

Located in the Scottish Border country, the Leaderfoot Viaduct has four of its piers with foundations in the river Tweed, the brick masonry is protected by stone block 'boots' designed to deflect water and flood debris. However in 1994, after more than a century of service, extensive cracking had developed between the stonework and the brick masonry both above and below the water line. Although not exceeding 5ft in depth, divers were required to assess the extent of damage underwater. A remedial solution for re-securing the two elements was devised by the installation of sixteen; $\frac{3}{4}$ inch Cintec rebar anchors, 6ft in length and four per pier.

The uncontaminated river is popular with salmon fishermen and the necessity to avoid any environmental pollution was uppermost in the minds of all those involved. As alternative un-contained methods of anchoring and grouting were out of the question, Cintec was the clear choice.

Under the supervision of the local river authority, holes were drilled at a downward angle through the boots and into the piers. These instantly filled with river water, however due to the unique nature of the Cintec anchor - filling a mesh fabric sleeve from the rear to the front, all water was fully displaced upon grout injection. The visible cracks were sealed manually by inserting lengths of sock into the fissures and expanding them. The subsequent watertight seal allowed conventional grouting to be injected into any remaining internal voids without danger of release into the water system.

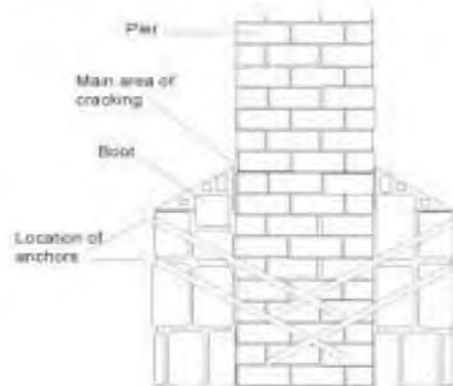

"Key hole Surgery for Bridges"

CASE HISTORY

Killiecrankie Viaduct Tayside, Perthshire Scotland, U.K.

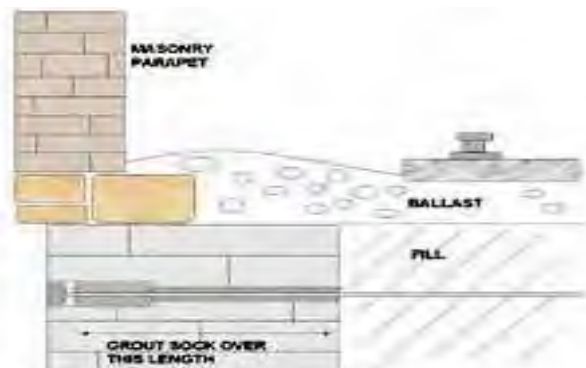

Cross sectional view of 15 ft three piece Cintec anchor.



In 1998 Killiecrankie Viaduct was both repaired and strengthened. The work was intended to increase maximum track speed and accommodate Intercity trains traveling up to 125 mph. These improvements were part of an extensive program covering the entire length of the Highlands Railway from Perth to Inverness in Scotland.

Following the contours of Glen Garry, the curvature of the multi-arch structure added to the engineering challenge. Engineering consultants Scott Wilson of Glasgow assessed that strengthening would be required in order that the viaduct withstand the increased lateral forces being exerted by high speed trains.

The solution was provided in the form of 1.2" Cintec deformed rebar anchors in lengths between 3ft and 15ft. Installed horizontally under the full width of the viaduct, the anchors passed from the masonry spangrel wall through the springing vee joints to the opposing spandrel wall. Only the anchor sections located within the spandrel walls were socked and inflated with grout (see above). To increase tension values the anchors were installed in stepped bore holes allowing the sock to expand beyond the diameter of the inner bore hole. Other anchors were installed through the voussoir stones into the masonry arch barrels. In total 230 Cintec anchors were installed by the experienced drilling company Ritchies of Kilsyth.

CASE HISTORY

Gumley Road Bridge, Leicester, UK.



The Structure

Gumley Road Bridge is listed red brick structure with a single span of 6.7 meters and a width of 4.9 meters between its parapet walls. It was built to carry road traffic over the Grand Union canal without impediment to boat traffic below. It had a weight restriction of 17 ton.

The problem

Working in conjunction with British Waterways, Leicestershire City Council required the bridge to be strengthened to carry the 40/44 ton Assessment Live Loading. With both the bridge and waterway in continual use, it was imperative to keep disruption to a minimum.

The solution

In total, twenty six stainless steel 25 mm diameter CINTEC anchors were installed from the road surface. All were between 2.9 and 3.1 meters in length. For the duration of the project regular vehicular traffic was diverted over another bridge, however it remained open to emergency vehicles, cycles and horses. Boat traffic below remained completely unaffected. Possession of the bridge was originally given over to Archtec for three weeks, significantly, Cintec's drilling and installation contractors APB of Stoke, actually completes the work in only 10 days and so brought back into full service far ahead of the time the council had allocated



Checking for sub-surface services during bridge survey



Temporary below arch protection during the installation process

CASE HISTORY

Deansgate Viaduct - Manchester U.K.



The busy Deansgate rail viaduct is situated in the heart of Manchester spanning numerous buildings, roads and canals. In 1997 the normal daily flow of rail traffic was disrupted by a destructive fire which took hold in a workshop located directly underneath. The subsequent heat generated by the blaze caused extensive damage and a weakening of the seven rings of masonry that form the arch barrels. The surface ring of brickwork completely delaminated and collapsed to the ground below.



A team of consulting engineers assessed the damage and recommended a Cintec reinforcement solution. Any remnants of the outer ring were completely removed and the remaining six rings were hammer tested to locate the extent and

area of internal delamination. Two arches were found to be in need of repair. In total approximately 500, 24 inch long RAC Cintec anchors were installed, perpendicular to the arch and at spacings of 20 inches. The anchors were staggered to avoid the formation of shear lines and because of their vertical aspect, each anchor was fitted with an air-vent tube to ensure full grout inflation without risk of air pockets being formed at their remote end. All anchors went no further than half way through the sixth ring so as not to puncture the original waterproof membrane that protects the arch barrel from the arch infill.

Finally the original appearance of the arches was restored by grouting an original piece from the drilled cores back into the mouth of each anchor hole. The completed work was rendered invisible to the naked eye and the viaduct was once again in operation servicing Deansgate station and the G-Mex conference centre.



"Key hole Surgery for Bridges"

CASE HISTORY

DUCK CREEK CULVERT, GRANVILLE FOR NSW RAIL CORPORATION SYDNEY , AUSTRALIA



The 6 metre span brick arch culvert at Granville in Sydney's western suburbs carries three tracks of the suburban railway system. Structural failure had occurred through overloading producing a crack along the top of the arch.

Railcorp engaged Bill Jordan & Associates to analyse the structure and produce strengthening recommendations. At first it was determined that a full concrete lining would restrict the flow and lead to unacceptable upstream flooding. Parramatta City Council required that flood levels could not be raised by more than 30 mm, and this precluded construction of an independent concrete structure capable of taking the loads. The solution was a thin concrete lining which acted compositely with the existing brick structure and it was found that Cintec anchors were the only system capable of transferring the high shear forces across the brick/concrete interface to achieve the composite structural action.

Cintec anchors made from 20 mm deformed stainless steel reinforcement bar were installed in 80 mm diameter holes, the hole diameter being determined by the need to distribute the large shear forces into the brickwork. Only Cintec gives the ability to design the anchor body and hole size independently to optimise the stress distribution in an anchor installation.

The installed anchors were then used to support standard concrete reinforcement for the "shotcrete" lining, which was given a tightly specified smooth finish to enhance the flow capacity.

CASE HISTORY

INDIA

Railway Bridge No.39 (Northern Railways)

Bridge No.39 is located on the rail line between Lucknow and Kanpur. Lucknow Division caters to both daily commuters and the transportation of goods. Due to the large and continuous flow of traffic over the bridge, minimum blockage and speed restriction was permitted. The bridge was analyzed and subsequently rehabilitated to carry MBG-1987 loading by way of insertion of Cintec Stitching Anchors. The execution of the work on site was completed in 10 days with minimal traffic disruption, maximum environmental protection and the preservation of the character of the bridge.



Lutyen Bungalow (New Delhi)

This bungalow which is primarily a masonry structure was built in the British era in the 1920s. It is the official Bungalow of the Chief Justice of India, New Delhi. The care takers, The Central Public Works Department, were concerned regarding the condition of the structure, particularly the cracks that developed at the corners/joints. Cintec India, (without defacing the original structure in any manner) carried out the analysis and subsequently strengthened the structure by stitching the cracks with the help of Cintec Stitching Anchors. The reinforced structure was restored to its historic character and handed back to CPWD after only 5 days on site.



Railway Bridge No.155 (Rail Vikas Nigam Limited [RVNL])

This stone masonry arch bridge consists of 26 spans of approximately 9.50 meters that was built in 1864. It carried a broad gauge track over the river Kushasthalaiyar, between Tiruvallur and Arrakonam until 1983 when it was abandoned. The scope of the work was to assess the current condition of the bridge and check whether it would carry the MBG-1987 loading and if found inadequate, suggest measures so as to make the bridge fit to carry the required loading. The analysis was done by using the software 'ELFEN', based on Finite and Discrete Element technology. All the defects found in the structure were taken into account and measures to strengthen the bridge structure for the required loading were provided in a detailed engineering report submitted to RVNL.

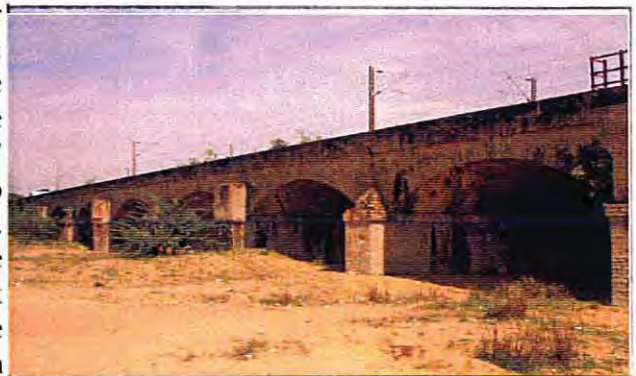

CASE HISTORY

Lucknow Bridge , INDIA



This bridge is in Lucknow division of Northern Railway, which is one of the sixteen zones of Indian Railway. The bridge lies between two important cities of India Railway. The bridge lies between two important cities of India i.e Lucknow & Kanpur. In addition to it the bridge is a part of main line connecting Delhi (Capital of India) to other parts of Indian particularly eastern part & almost all major trains pass through this bridge.

The bridge was originally designed to carry meter gauge loading but currently is carrying Modified Broad Gauge loading i.e. 25t axle load.

In absence of any proven analysis system Indian Railway were sure of the carrying capacity of the bridge hence they requested Cintec to check the same & strengthen it if found weak.

Cintec international Ltd. In association with Gifford simulated the bridge by using ELFEN software which is based on FE/DE technique

As a result of analysis it was found that the bridge is safe for carrying the current loading: however as a remedial measure in addition to horizontal anchors for stitching of minor crack, radial anchors were installed in arch barrel to counter any probable ring separation.

The analysis was counter certified by IIT-Delhi (Indian Institute of Technology). Which is a premier engineering institution of India.

PARAPET WALL STRENGTHENING

PARATEC

PARAPET WALL STRENGTHENING FROM CINTEC

No two masonry arch bridges are the same, this also applies to their parapet walls. The requirements specified for individual walls can differ considerably and must reconcile a variety of needs. These may include impact containment, vehicle redirection, the protection of others in the vicinity, compatibility with the masonry structure as a whole, as well as the visual appearance of the strengthening solution implemented.

The Cintec Anchor System provides a highly versatile method of internal structural reinforcement that is tailored to meet the specific requirements of each parapet wall. This service, known as Paratec is backed by extensive research and development, this includes advanced computer modelling, practical testing and also the experience built up from numerous strengthening projects. The Paratec system can strengthen a masonry wall while remaining sensitive to the original architecture and without any narrowing of the road way.

Research & Development



The comprehensive service offered by Paratec include advanced computer modelling techniques that simulate the effects of a vehicle impact upon a specified masonry wall. Working in conjunction with both software specialists and consulting engineers, Paratec utilises an advanced dynamic software incorporating a discrete element analysis technique that enables the behaviour of parapet walls to be accurately predicted under various circumstances.

Practical Testing: Tyne-Tees University

Dynamic full-scale parapet wall tests were undertaken in the heavy structures laboratory at Tyne-Tees University. The tests clearly demonstrated the robustness of parapet walls reinforced with Cintec masonry anchors. The walls were impact loaded using a falling weight test rig designed to generate the force/time history of an actual vehicle impact test that had previously been recorded and analysed at MIRA. In this test, the Cintec reinforcement used was a 19.5 metre high yield MS multibar anchor comprising six individual stainless steel bars of 8mm in diameter. This was installed 370mm below the top of the wall. Raking anchors were also installed in pairs at 30° to the vertical. These were 1 metre long 3 strand 8mm diameter multibar anchors encapsulated in a 40mm diameter sock and installed in a 50mm diameter hole. **The next page illustrates the strengthening of the parapet walls of Magdalen Bridge, Oxford.**

CASE HISTORY

Telford Magdalen Bridge, Oxford, U.K.

On May 1st of each year Magdalen Bridge becomes the focal point for Oxford's May-Day celebrations. Choristers traditionally sing from the tower of Magdalen College located at the Oxford end of the bridge, attracting both students and tourists to listen and enjoy the atmosphere. For some, these festivities can even include jumping from the parapets into the river Cherwell below.

A test on the strength of the parapets had been originally undertaken in 1998. There were concerns about the pressures being imposed upon the parapets by the people standing on top of them and also by the large crowds that may push against them.

This test revealed that the 6m length of parapet was unable to withstand a load of 2.0kN/m. This result revealed considerably less strength than had been anticipated and therefore some form of remedial work was considered necessary. In February 2002 another section of parapet was tested on the South West Side over the first span heading towards Oxford.

The section had been reinforced with Cintec anchors over a 5.66m length. It was conducted in compliance with the requirements of The Home Office Guide to Safety at Sports Grounds Fourth Edition and used specially designed barrier load testing rigs (see figure 1). Deflections were monitored with dial gauges having a resolution of 10 microns.

A load level of 5kN/m was requested by the client. The parapet was initially loaded up to a bedding load 4kN/m to remove any slack from the components of the parapet. It was then loaded to 5.0kN/m to observe the level of deflection. The parapet was found capable of accepting the load and the maximum deflection measured was 0.57mm at approximately midway between two die blocks located either side of the test length (see Test Certificate below). Because of the successful trials, the parapet walls for the entire lengths of Magdalen bridge will be strengthened with Cintec anchors. Vertical M20 anchors of 2m are located within the die blocks and M25 anchors of 4.5m are installed through the pilasters. The horizontal anchors are M16 and between 7m and 10m in length.



Figure 2 shows the holes drilled horizontally through the parapet. Figure 3 shows a horizontal Cintec anchor prior to installation

CASE HISTORY

LOAD TESTING OF MAGDALEN ROAD BRIDGE PARAPET OXFORD ISIS ACCORD						JOB REFERENCE No: IA/503/03			
BEDDING CYCLE						BARRIER DETAILS			
		Deflections/mm				Length	5.66 m	Factor(1.1/Height)	0.88
Pressure/psi	Load/Ram/kN	G1	G2	G3		Height	1.25 m	No of rams	5
0	0.00	44.48	41.86	48.54		Spacing	n/a m	Total des. service load	19.92 kN
280	0.80	44.38	41.57	48.33		Gradient	n/a °	Max load/ram (bedding)	3.98 kN
535	1.59	44.14	41.13	47.93		Bedding load	4.00 kN/m	Total proof test load	24.90 kN
780	2.39	43.71	40.42	47.30		Design load	5.00 kN/m	Max load/ram (proof)	4.98 kN
1045	3.19	43.18	39.67	46.56		TEST ARRANGEMENT			
1300	3.98	42.42	39.38	45.50					
0	0.00	44.13	41.37	48.17					
Maximum deflection/mm		2.06	3.48	3.04					
Maximum Permanent		0.35	0.49	0.37					
Deflection/mm (Max=2mm)									
Recovery% (Min=75%)		83.0	85.9	87.8					
PROOF CYCLE						Date Tested: 22/02/02			
Pressure/psi	Load/kN	G1	G2	G3		OBSERVATIONS PRIOR TO TESTS			
344	1.00	43.85	40.79	47.61		Test conducted on section strengthened with Cintec 'anchors', on South West side of bridge, on span nearest Headington end. Locations 1 - 3 tested in 1998. Missing coping stone and horizontal reinforcement bar, to right of test. Test length shortened to 5.66m, away from missing coping stone.			
663	1.99	43.40	40.01	46.93					
981	2.99	42.83	39.17	46.19					
1300	3.98	42.22	38.22	45.33					
1618	4.98	40.88	38.47	43.84					
LOAD MAINTAINED FOR FIVE MINUTES						OBSERVATIONS DURING & AFTER TESTS			
1699	4.98	40.49	38.18	43.61		Cracks appeared in mortar joints under tension during loading, i.e. at rear face of coping mid-span, at front face of coping near end of span, and joint between ballusters and ballustrade plinth. Cracks visible under load closed on release of load. One cycle of bedding load and one cycle of full load applied as instructed by engineers on site.			
0	0.00	43.83	40.80	47.87					
Maximum deflection/mm		3.64	5.19	4.56					
Maximum Permanent		0.50	0.57	0.50					
Deflection/mm									
Recovery% (Min95%)		86.3	89.0	89.0					

CASE HISTORY

London Underground, U.K.



Post-Tensioning Cintec anchor in test panel..

Two 16mm diameter 2 stage anchors were installed vertically, the anchorage length within the supporting structure was then inflated and left to fully harden. The anchor was then tensioned and the second sock occupying the remaining space in the masonry wall was inflated.

Once the anchors were cured, an applied wind loading was simulated by the application of a lateral point load on a horizontal spreader beam positioned at the walls centre. An incremental lateral load up to 3.5kn/m was applied by a hydraulic jack which demonstrated a linear elastic response.

The predicted response, calculated beforehand and based on assumed values for the material properties, was within 30% of the measured values. Bearing in mind the wide range of uncertainties in relation to the wall stiffness and strength, this demonstrates an adequately high level of accuracy. On completion of the test, no cracking or spalling was observed. It was concluded that the scheme presented both “an economic and aesthetic solution to the refurbishment of understrength and unstable masonry parapets”.

London Underground has a great many brick walls and parapets supported on elevated structures. As it is the world’s oldest underground system, many of the walls are between 100 and 150 years old and are consequently suffering from a degradation of the mortar which is invariably lime based.

An insitu load test was carried out in order to demonstrate the applicability of Cintec anchors for both stabilizing and for strengthening them against dynamic air pressure loading. The test was also used to confirm that the performance of the strengthening wall had been correctly calculated and thus provide assurance of the methodology.

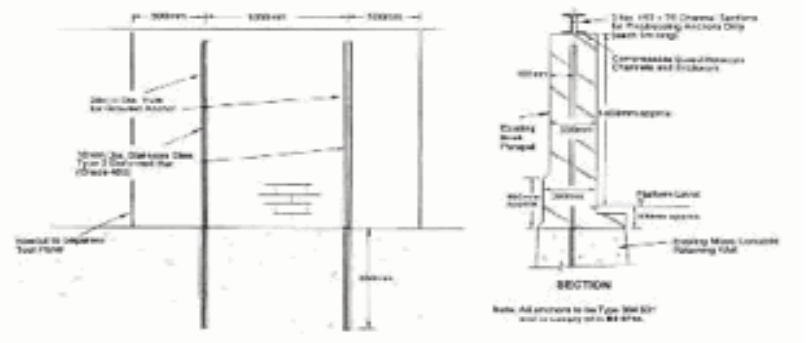

Details of test panel strengthening scheme.



CASE HISTORY

Parapet Wall Strengthening Inclined Plane Bridge – Coalport U.K.



Spanning the river Severn at Coalport in Shropshire, the Inclined Plane bridge is a registered ancient monument and as such, any alteration to its appearance is unacceptable. The Archtec method of bridge reinforcement was chosen to increase the load bearing capacity of the structure, a need was also recognised to strengthen its parapet walls.

A solution was achieved by the installation of Cintec 16mm studding anchors, of between 1.5 and 3metres in length. These were designed with two individually inflated socks and were installed vertically at 1metre intervals through the parapet walls and into the barrel of the arch. The lower (arch barrel) sock was then inflated and left to cure. The second sock was then inflated and placed under a tension of 10kN by using a tensioning plate. This sock was then cured and the tensioning plate removed.

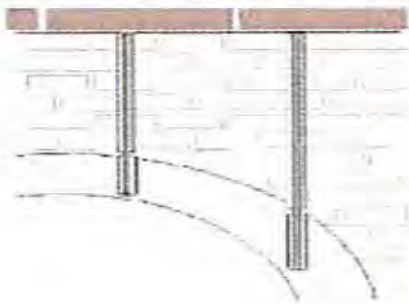

Finally the sandstone parapet coping stones were replaced and two missing stones reproduced. The solution provided the necessary increase in wall strength without having any visible change to its appearance.

CASE HISTORY



PEARTREE STATION BRIDGE

PARAPET WALL STRENGTHENING

Peartree Station Bridge carries the Derby ring road (A5111) over the main rail connection between Derby and Birmingham. For reasons of safety both the North and South 40m long parapet walls required significant strengthening. A level of containment in excess of P1 was agreed based upon the 1500mm wall comprised of brick with a concrete core. A detailed survey and bridge analysis revealed highly variable brick quality, an unpredicted sandy core fill and extensive services running through the structure. A large gas main near the north wall (*fig 1*) further complicated drilling and anchor placement. An engineering solution was provided by Giffords of Southampton using an extensive array of Cintec anchors installed vertically, horizontally and diagonally. Work commenced in early 2004. With the use of non-percussive diamond core drilling, vertical anchors of 25mm diameter high grade stainless steel were installed through the parapet wall in 65mm diameter holes, these varied in lengths of 1.3 to 3.6 metres. A matrix of over 600 smaller 10mm diameter consolidating anchors 0.5m in length (*fig 2*) ensured both the brick and concrete elements of each wall acted together in the event of a vehicle impact. 16mm diameter transverse anchors within the barrel of the arch (*fig 3*) were installed to spread the load of an impact into the body of the structure and finally a series of 32mm raking anchors were installed diagonally from the base of the concrete wall lintel (*fig 4*) and secured at their base into tapered holes to ensure a maximum required loading of 245kN.



Fig 1. Excavations revealed a large gas main close to the north wall.

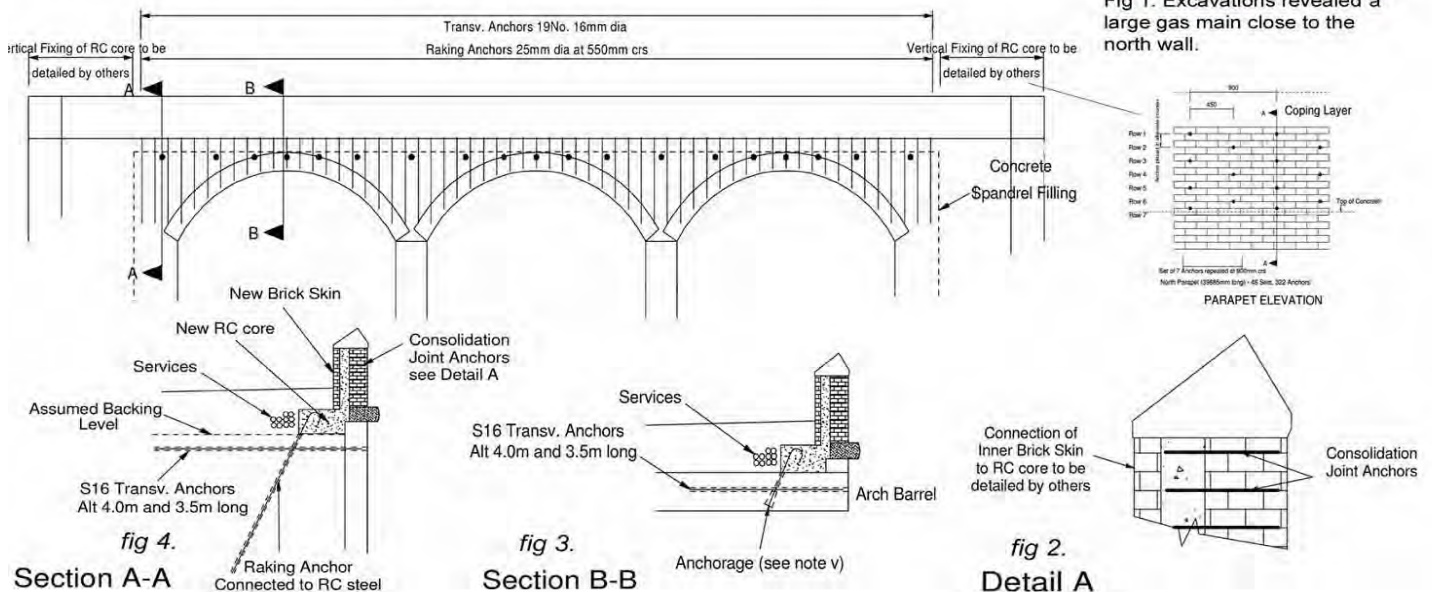

CASE HISTORY

Upper Kilmacud Bridge Dublin- Ireland



Parapet Wall Strengthening

The parapet walls of Upper Kilmacud Bridge were allocated for strengthened as part of the Dublin Light Railway Project. The single span brick structure carries a two-way carriageway approximately 5.5m wide and two footpaths of 1 and 1.5m in width. The parapets themselves are of granite block masonry some 0.4m in thickness and varying between 1 and 1.5m in height.

The bridge has a 30 mph (48kph) speed imposed limit, however in order to ensure greater safety, and following a collision in which a section of the wall was damaged, a vehicle containment level of P6 was requested. Such a high containment rating required extensive engineering to not only strengthen the parapet walls, but also to upgrade the barrel of the masonry arch in order that it absorb the forces of an impact without causing major structural damage. Drilling and anchor installation was undertaken by TST Ltd during the summer of 2003. The project involved a total of No.98 Cintec anchors all made of ribbed bar high-grade stainless steel. Using stone of similar type and appearance, each wall was heightened to a uniform 1.5 metres and then strengthened horizontally with No.5 13m long anchors (Fig 1). These anchors ran the entire length of the parapet walls. In turn, the horizontal anchors were supplemented with vertical anchors of 32mm diameter reinforcement bars installed from the top of the parapet walls and down into the barrel of the arch. Their lengths varied from 5.1m to 2.7m according to location (Fig 2). Finally, No.8 transverse anchors were installed through the fill and so unifying the various structural elements of which the bridge is comprised (Fig 3).

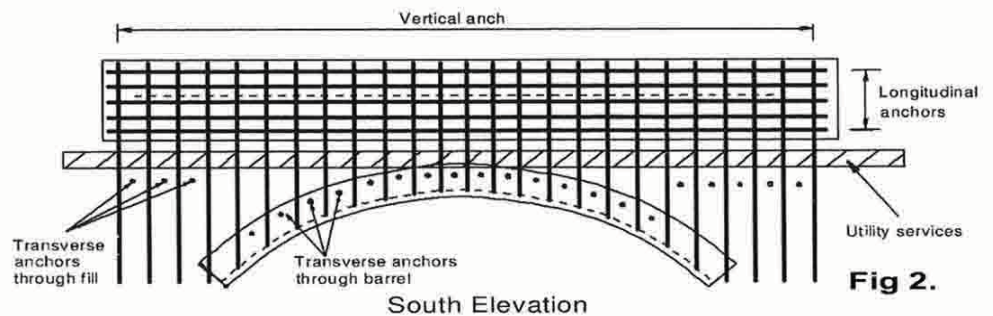
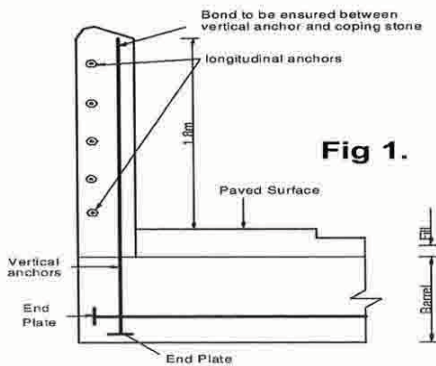
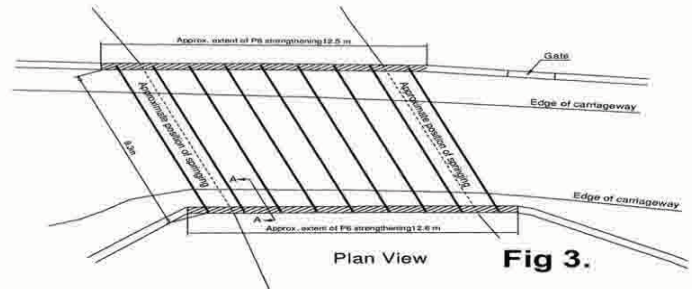

the award winning
CINTEC

*strengthening,
repair and stabilization
of high-rise buildings*

CINTEC
WORLD WIDE

SECURING THE PAST FOR THE FUTURE

CASE HISTORY

HEMSLEY BUILDING 230 PARK AVENUE, NY, NY U.S.A.: TERRACOTTA REPAIR



The Property

This “recognized iconic asset” to the New York City Skyline is located in midtown Manhattan and was built as a Beaux-arts style building in 1929. The property strategically straddles Park Avenue at 46th Street and offers a direct connection to Grand Central Station. It was acquired (2007) for One Billion One Hundred and Fifty Million USD.

The Problem:

By 2009, the building had begun to show its age. At the top of the building some of the twenty-six east and south facing Terra-Cotta columns [with the base starting at the 26th floor and extending past the 34th floor] had begun to show cracking and in some areas had begun to shed large pieces of stone. The building owners/management had inquired as to replacement cost of these Terra-cotta Brackets and had been quoted prices exceeding 16 Million dollars. By employing the Cintec method of repair, the owner was able to save more than 15 million Dollars effecting by repairs for just over 1million dollars.



The Solution:

CASE HISTORY



Cintec in North America was contacted by Thornton Tomasetti Engineering Corporation to find a solution to this issue, working together Cintec North America and Tomasetti Engineering Corporation formulated a plan. Through exploratory probes and use of a borescope it was assessed that the structure behind the columns (staked brick) was sound, given this assessment it was decided that all that would be needed would be to attach the Cintec Anchoring System to the backup and tie it to front face of stone that was sound in order not only to strengthen the attachment to face but to create additional points of contact in the stone face brackets that were sound. This was achieved by drilling oversized holes through the face of the stone and recessing the anchor 1" from face of stone to accommodate a finish patch, thus creating an invisible repair. The ability to tie the face of the original Terra-cotta panels to the back up wall saved the integrity of the landmark building.

Savings:

By affecting, this repair method as opposed to fiberglass replacement and demolishing landmark terracotta brackets and columns, the owner was able to save more than 15 Million dollars and effect repairs in less than a quarter of the time needed to replace brackets. The General Contractor on this project was United Restoration Corp who worked closely with Cintec North America, Thornton Tomasetti (Engineer of Record) and Arteco Design Corp (Driller/Installer) to complete this project with minimal issues and maximum savings.

General Contractor
United Restoration Services of
NY
295 Greenwich St, Ste 341
New York, NY
10007
Tel: 212-431-1261

Engineer of Record
Thornton Tomasetti
24 Commerce Street, 8th Fl
Newark, NJ
07102
Tel: 877-993-9737

Specialist Masonry Contractor
Arteco Design & Restoration
8 Bogart Place
Yonkers, NY
10708
Tel: 914-793-9424



Pull Out Tests for Cintec Anchors carried out on the EMPIRE STATE BUILDING, NEW YORK

COMPANY ADDRESS
LZA TECHNOLOGY
641 AVENUE OF THE AMERICAS
NEW YORK
NY 10011

TEST ANCHORS & RESULTS

Date: 16/12/94

SITE ADDRESS
EMPIRE STATE BUILDING
5TH AVENUE
NEW YORK

The Cintec Anchors were installed on December 8th, 1994 at the 6th floor elevation by David Aston in the presence of Mr. Robert Wagner, LZA Technology and Mr. Robert Wagner, Senior Project Director of Empire State Building. The anchors were used being of different lengths.

TEST REQUIRED	TEST NO	INSTALL TIME	TYPE OF ANCHOR	LOAD REQUIRED	LOAD ACHIEVED	BASE MATERIAL	STOCK IMBEDMENT	STOCK DIAMETER	PULLOUT TIME
1) To Test Brick Facade	1	20 mm	3/8" Solid Bar	1000lbs	3200lbs	STONE	2 3/4"	1"	10 MINS
	2	20 mm	3/8" Solid Bar	1000lbs	2800lbs	STONE	2 3/4"	1"	10 MINS
2) To Secure Brick Facade on 6th Floor	3	20 mm	3/8" Solid Bar	1000lbs	3200lbs	STONE	6 3/4"	1"	15 MINS
	4	20 mm	3/8" Solid Bar	1000lbs	3150lbs	BRICK	6"	1"	10 MINS
	5	20 mm	3/8" Solid Bar	1000lbs	3000lbs	BRICK	6"	1"	10 MINS

PERSONS PRESENT ON TEST / DEMONSTRATION

PRINT NAME	COMPANY	POSITION	PHONE NUMBER
MR ROBERT WAGNER	LZA TECHNOLOGY	SENIOR PROJECT DIRECTOR	212 741 1300

COMMENTS

It should be noted that at the achieved loads no failure of the anchors was observed, in addition there was no visible damage to the areas surrounding the test anchors.

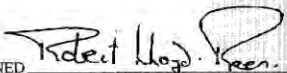
SIGNED FOR & ON BEHALF OF CAVITY LOCK SYSTEMS LTD
POSITION:- CLS NORTH AMERICA

CLS CINTEC CANADA LTD.
38 Auriga Drive, Suite 200
Nepean, Ont. K2E 8A5
613-225-3381

Type 1 overall length 3 3/4" soaked 2 3/4" for testing in 4" thick limestone panels.

Type 2 overall length 7 3/4" soaked 6 3/4" for testing in 8" thick limestone panels.

Type 3 overall length 11" soaked 6" from the rear for testing the brick back up wall.



Testing was carried out 8 days after installation by David Aston, in the presence of Mr. R. Wagner using a Mark IV Hilti Test Meter Serial No. 01632.

The loads achieved are set out on the test date result sheet overleaf. It should be noted at the achieved loads there were no failures or any visible damage to the areas surrounding the test anchors.

CASE HISTORY

TERMINAL TOWER, CLEVELAND, OHIO, USA

This imposing building, was once the main rail Terminus for Cleveland. It is a most significant landmark. When it was built, as part of the Van Sweringen brothers' Union Terminal, it was the tallest building outside of New York City until 1967 when Boston's Prudential Centre was built; the original design of the Terminal lacked the tower. Terminal Tower remains the second tallest building in Cleveland and Ohio, and has recently been refurbished for use as a prime commercial centre. The centre includes some of the finest shops, offices and restaurants in the City. As part of the refurbishment, parts of the masonry were in need of radical repair; Cintec was contacted. Following an inspection by the project engineers, repairs to the masonry were carried out at the same time as the contractor was inspecting the masonry from a swing stage. Cintec Anchors Type RAC with a single sock 12" (300mm) long and double sock anchors 17³/₈" (450mm) long with a 4" (100mm) sock at each end were inserted into ³/₈" (20mm) diameter holes and inflated using grout filled cartridges and a caulking gun. RWT ³/₈"x³/₈"x29¹/₂" (15x15x750mm) anchors were used to stitch the soffit stone at the upper band course.

Engineers

Webster Engineering Associates, Cleveland, Ohio, USA

Contractors

M.A. Building & Maintenance Co., Cleveland, Ohio, USA

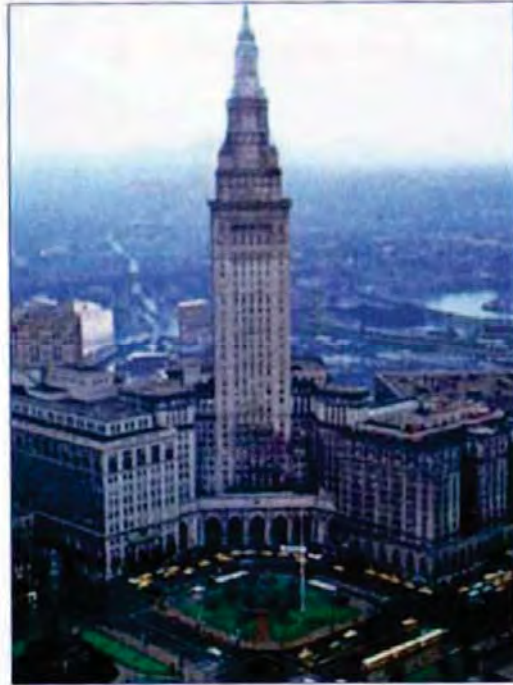

ESSEX COUNTY NEW COURTS BUILDING AND JAIL NEWARK, NJ, USA



Limestone cladding of Essex County New Courts Building and Jail was one accident away from catastrophic failure. Cintec installed more than 20,000 anchors to prevent masonry's collapse.

The 1966 building's limestone curtain wall panels had separated from the structure. This caused damage so pervasive and severe that the building was, in architect Michael Zemsky's words, one accident away from catastrophic failure."

Several new technologies were considered for the repair of the Essex County Courts. Some of the new repair techniques proposed introducing modern materials into historic fabrics, but experts shied away from chemical based fixes, such as epoxies or resins and high strength mortars, as both can damage buildings more than the forces they are trying to correct.

"Compatibility is the key when fixing old masonry," explains

Michael Schuller of Atkinson-Noland Associates, a masonry evaluation and repair consultant in Boulder, Colorado. "If you place a really stiff material, such as mortar, next to a softer material, you'll likely get cracking and spalling in the masonry. If there's an epoxy barrier, you'll have water-vapour transmission problems." The most dramatic recent advancements in masonry preservation technology focus on strengthening and connectivity. In the face of seismic forces, wind loads, vibration from vehicles and machinery, inadequate original design, new adaptations, and aging, stabilizing masonry is becoming a more critical element of rehabilitation and historic preservation efforts. Cintec designed anchor systems offered the best alternative to invasive or unsightly structural systems.

CASE HISTORY

Essex County Court House continued

One of the best things about this system is that the material is cementitious, not epoxy-based," explains Westfield, New Jersey, architect Michael Zemsky. The most interesting part is that the nylon sock expands to fill the cavity until it is completely wedged in, the exterior is then patched. The wall is then better able to withstand vertical forces and is generally strong".

that before they inserted more than 20,000 Cintec anchors into the building, they had an independent lab test the system by measuring the strength of the anchors' hold on the masonry. The pullout tests exceeded 4,000 pounds," Papandrea says of the procedure, in which steadily increasing force is applied until the anchor fails. The block broke before the anchor did."

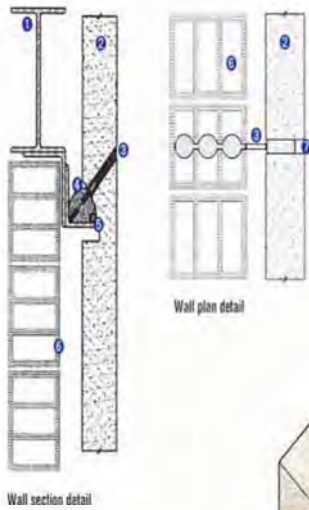

- ① structural steel beam
- ② limestone panels
- ③ Cintec anchor
- ④ expandable nylon sock
- ⑤ steel relieving angle
- ⑥ masonry backup
- ⑦ patching compound
- ⑧ grout flood hole
- ⑨ stainless steel member
- ⑩ end plate



CASE HISTORY

77 HOWARD STREET, TORONTO, ONTARIO, CANADA

Exterior wall restoration

This 24-storey apartment block's exterior wall consists of two wythes tied together by courses of header bricks. The exterior wythe is a glazed clay brick and is supported by a painted steel shelf angle connected at each floor into the floor slab. The inner wythe consisted of a 4" hollow concrete block back-up wall. Deterioration is due to vertical loads imposed by shortening of the structural frame. Lack of soft joints below the shelf angles to accommodate movement has resulted in;

1. Bowing of walls.
2. Crushing of over stressed units.
3. Shear failure of the header courses.
4. Rotation of shelf angles

Corrosion deterioration has also occurred in the shelf angles and connecting bolts. Due to occupation of the dwellings, complete replacement of the walls was impractical. Thus Halsall Associates in conjunction with CLS Cintec Canada participated in the development of a stabilization strategy.

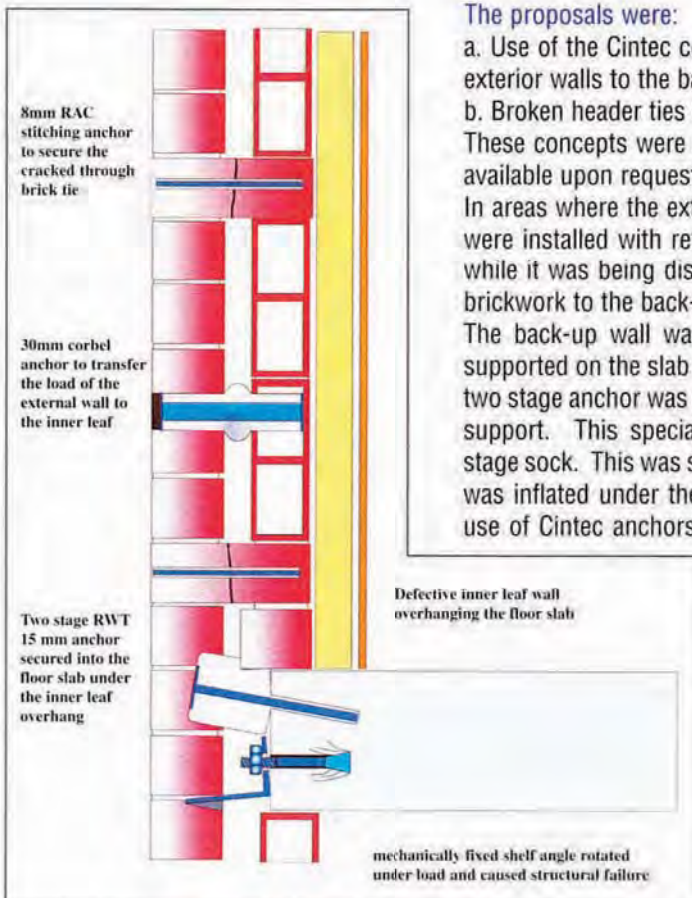

The proposals were:

- a. Use of the Cintec corbel anchor to transfer vertical loads from the exterior walls to the back-up walls.
- b. Broken header ties to be restored using Cintec stitching anchors. These concepts were proven with full laboratory load tests. Results available upon request.

In areas where the exterior walls were beyond repair, Cintec anchors were installed with retaining plates to prevent collapse of the panel, while it was being dismantled. The anchor was used to tie the new brickwork to the back-up wall.

The back-up wall was found, during construction, to be not fully supported on the slab edge at some locations. A special RWT, 15mm two stage anchor was designed and supplied to provide the necessary support. This special two-stage anchor had an oversized second stage sock. This was secured into the floor slab, and the second stage was inflated under the inner leaf overhang to provide support. The use of Cintec anchors thus provided stabilization and repair on this

project, without disturbance or relocation of the tenants.

Conclusions of the Test Report:

The test assembly failed by crushing of the concrete block interior (back-up) wythe at the corbel anchors. The observed failure load of 10.3 Kn (2295 lb) exceeded the design (service) load of 2.85 Kn (636 lb) by a factor of 3.6.

Engineers

Halsall Associates, Toronto, Ontario, Canada

Contractors

Maxim Group General Contractors, Concord, Ontario, Canada

CASE HISTORY

HIGH RISE REMEDIAL WORK AT FITZWARREN COURT, SALFORD, ENGLAND, U.K.



Fitzwarren Court is a large panel construction high rise, and over its life had suffered from the ingress of water which not only caused the normal structural damage and inconveniences, but also led to the deterioration of the panel fastenings.

Engineers Wright Mottershaw had experience with this type of structure elsewhere in the UK and proposed the Cintec System as being the most appropriate to fasten the external and inner skin to the hollow floor beams.

CASE HISTORY

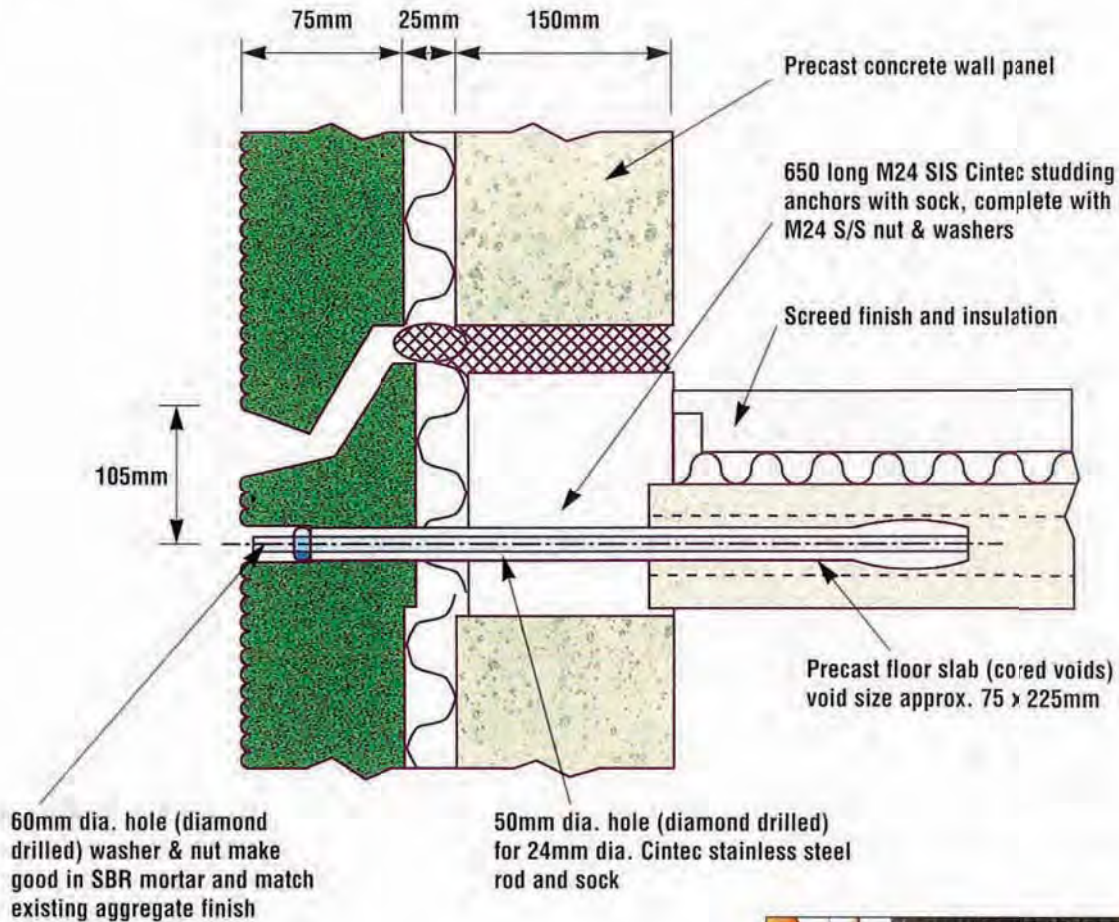

The design required a working load per anchor of 40kN and 75kN ultimate in tension. In tests during installation the anchors exceed these parameters.

The anchors were designed to inflate within the void of the floor beam and were inserted through a 50mm diameter hole in the outer and inner skins and into the end of the void - a horizontal slot approximately 60 mm x 150 mm with radius ends.

The anchor body was of high tensile stainless steel studding, capable of carrying the load, surrounded by a fabric sock to contain the cementitious grout. At the outer end, an exposed stud protruded by approximately 200 mm to facilitate the termination to the outer panel via a counter bored hole and heavy gauge large washer and nut.

Concrete repair techniques were used to finish and hide the bore hole.



Locating the floor beam voids presented some initial problems but these were resolved by site investigation by the contractors and engineers together and the time taken up by the problem was quickly reclaimed and the project finished ahead of schedule.

This unique system was chosen because of the engineering benefits, not least of which was the total control of the grout field; but also there was no need to require the occupants of the block to leave, because all the work could be done from the outside.

The problem of Fitzwarren Court are not uncommon, Cintec has since used this remedial repair system on other structures, both High and Low Rise.



Drilling



Anchor prior to injection



Injecting grout into anchor

CASE HISTORY

OLIPHANT COURT, PAISLEY, STRATHCLYDE



Scottish Special Housing Association designed and supervised the renovation of this fourteen storey apartment block using the Cintec corbel anchors and wall ties during 1987/88. The block was constructed of an insitu reinforced concrete frame with concrete floors and an insitu edge beam with an overhanging nib to support the external brickwork. creep and shrinkage of the concrete frame were primarily responsible for cracking and bowing of the external brickwork.

The external brickwork required replacement, so the outer leaf was dismantled. Re-building of the outer brickwork leaf was accelerated by the provision of the stainless steel angle supports at each floor level. The simple horizontal corbel anchor into the slab could not be employed because it would have cut the top edge beam reinforcement. Instead, Cintec corbel anchors inclined at 45° were supported over the downstand beams and used to support the stainless steel angles supporting the external leaf of brickwork. The

brickwork was built off the steel angles in storey heights with thermal movement joints at the underside of the angle over. Cintec RAC wall ties were used to tie the new leaf of brickwork to the internal leaf of blockwork.

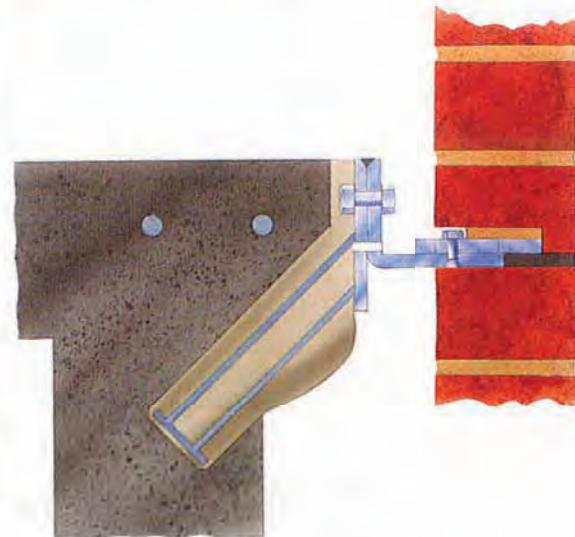
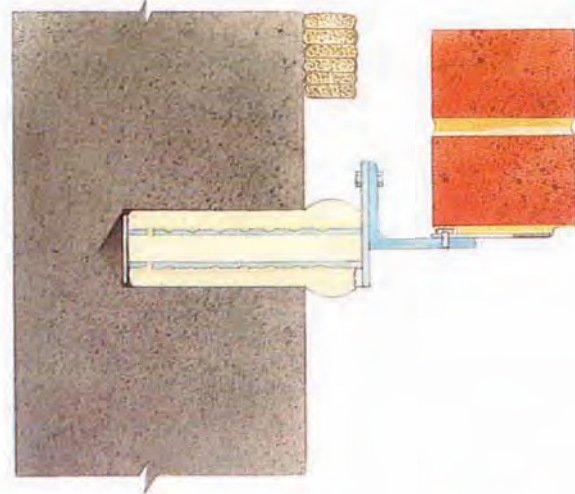

Section through floor edge beam

CASE HISTORY

HIGH RISE APARTMENT BLOCKS, GLASGOW



Scottish Special Housing Association designed and supervised the renovation of 18 No. fifteen storey apartment blocks using Cintec corbel anchors and wall ties during 1984-1987. Typically the blocks were constructed of insitu reinforced concrete inner walls, columns, beams and floors with brickwork cladding on the edge of the floor slab and supported by the concrete frame. The major defect was the deterioration of the concrete nib supporting the brickwork cladding with subsequent cracking and bowing of the external brickwork. These problems were caused by creep and shrinkage of the concrete frame.

The support provided by the concrete nib was replaced by the installation of Cintec corbel anchors at approximately 700mm centres at each floor level. The anchors were embedded approximately 90mm into the inner concrete leaf

The corbel anchors were 30 x 30 x 3 SHS stainless steel sections with an external sock in a 60mm diameter core holes, which was filled with grout injected under pressure of approx. 3 bars. The external face was filled with a high-bond expanding mortar to match the existing brickwork. Cintec wall ties, 10 x 1 CHS stainless steel sections in a nominal 20mm diameter core hole, were used to restore the integrity of the brickwork panels to the required standard. Laboratory tests were undertaken on the compressive strength of the grout and the metallurgical and tensile properties of the stainless steel sections, whilst the installed anchors were checked using borescopes for deformed shape and adequacy of fixing.

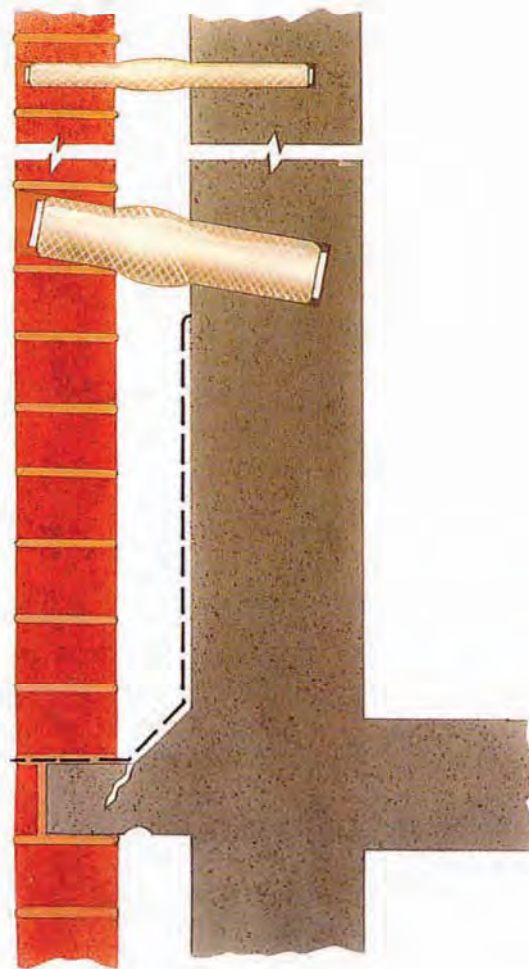

Section showing nib detail
at floor level

CINTEC

**Engineered Micro Cement
& Lime Grout Anchor Systems for
Earth Retaining & Ground Anchors**



"The Orthopaedic Surgeons for the Construction Industry"

Combi-Tec Ground Anchoring

Combi-Tec is a unique system which provides a totally concealed top termination for its Duckbill ground anchors. It enables structures to be effectively and sympathetically stabilised without any visible disturbance to the fabric or the need for unsightly external pattress plates, making it ideal for historic and listed structures.

After coring out or removing a complete brick or stone, the Duckbill anchor is installed and tensioned to its proof load. The Combi-Tec, consisting of a stainless steel tube, circular front plate and special polyester sock developed in conjunction with Cintec, is inserted over the anchor bar with the plate sunk below the surface of the masonry. Cementitious grout is injected into the sock under pressure until it has filled all the voids and, having cured, it forms a chemical/mechanical bond within the wall. The anchor is then re-tensioned to its working load and secured against the recessed plate before the fascia core, brick or stone is replaced and made good to fully conceal the anchor.

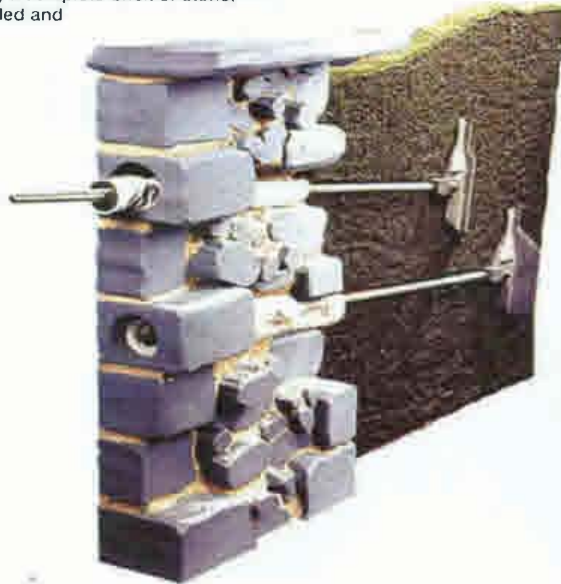

Hand held

1. Remove stone or brick or core drill clearance hole



2. Position anchor for installation



3. Drive in anchor to required depth



4. Insert Combi-Tec over Duckbill anchor



5. Inflate sock by injecting cementitious grout and leave to cure



6. Tension anchor to working load and secure to recessed front plate with load nut



7. Crop excess bar, mortar around Combi-Tec



8. Replace cored material and make good

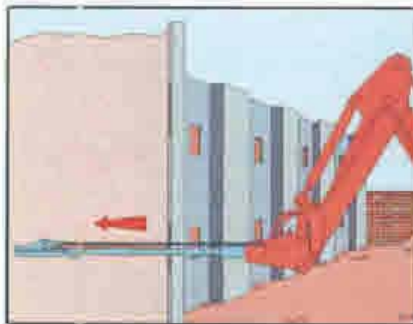

Duckbill anchors are designed to be driven into the ground using hydraulic or pneumatic equipment, with little or no disruption to the structure or surrounding area.

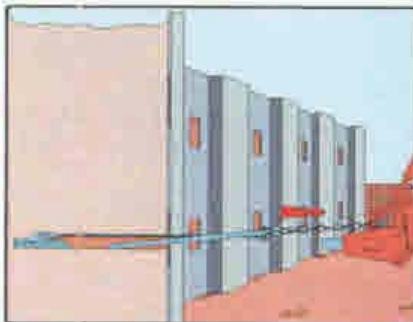
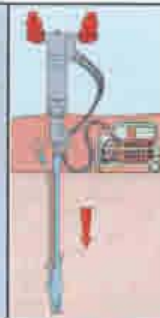

Once the anchor has been driven to the required depth the drive rod is removed.

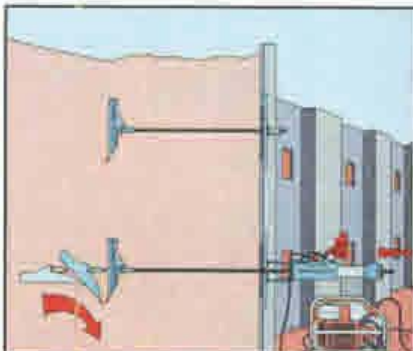

A tensile load is applied to the attached tie bar or tendon. This rotates the anchor into the locked position for maximum load holding capacity. The anchor is then proof tested to the designed loading requirements before the top termination is fitted, as specified by the civil or structural engineer.



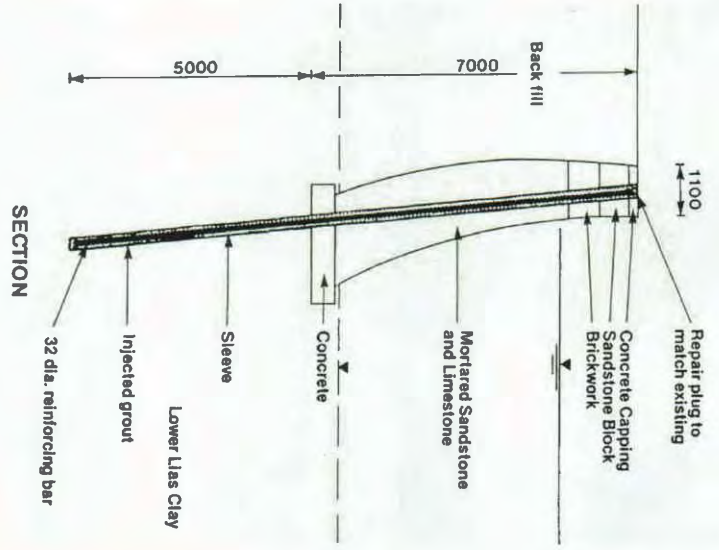
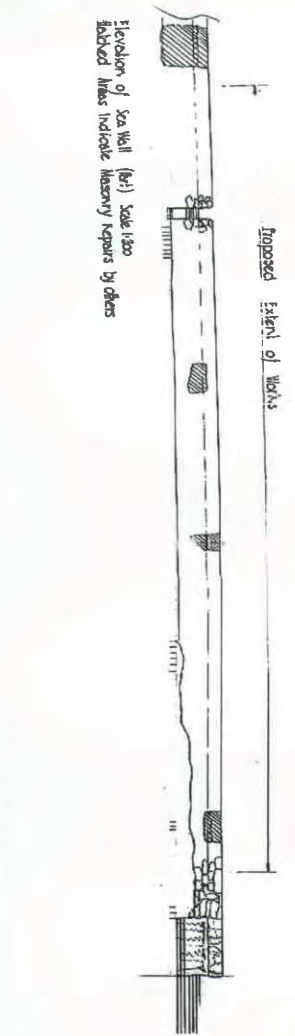
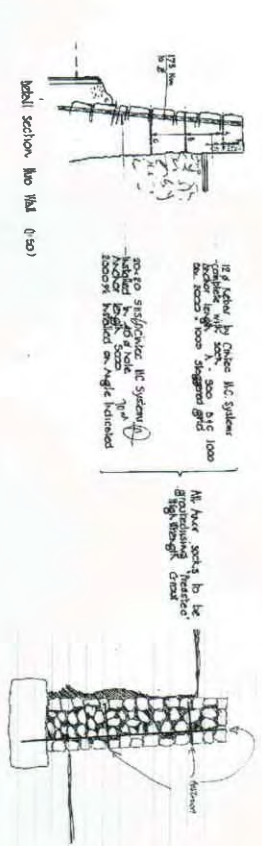
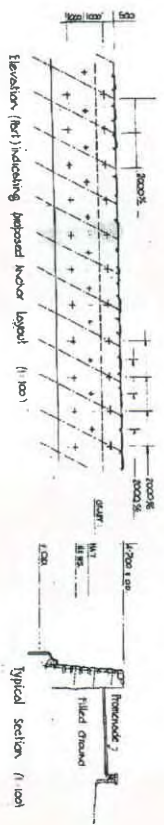

STABILISATION OF QUAY WALL

Harbour Wall Ground Anchoring

Strengthening of Zeebrugge Harbour Wall (Belgium)



Marco Island Sea Wall - Florida USA

(An early example of Cintec ground anchoring)

March 1983 - Following a move from Germany to a new home on a Florida island, Civil Engineer Paul Pella was faced with a structural problem common to the region - subsidence and dislocation of the protective sea walls surrounding the homes built upon the island.

Fortunately for Mr Pella, his engineering experiences back in Europe provided him with an innovative new technology ideally suited for stabilising these concrete structures - Cintec Anchors. The ground behind the walls consists essentially of sand, not considered an ideal medium for any form of anchorage. However the adaptability and unique features of the Cintec system overcame any potential difficulties associated with this soil type.

Consisting of a steel rod enclosed in a mesh fabric sleeve, the principle of the system is to inject a specially developed cementitious grout into the restraining sleeve of the anchor and so inflate it along its entire length. As well as providing an extremely strong mechanical bond, some liquid or 'grout milk' passes through the material membrane and bonds with the original substrate beyond.

In the case of Marco Island, an additional wide section of expandable sleeve, or sock as it is often called, was attached to the far end of the anchor. When the grout was injected, the additional section expanded to a diameter greater than the rest of the anchor. This created a bulb deep within the soil and ensured a truly secure point of anchorage.

As can be seen in the images (right) the individual boreholes were produced by diamond core drilling, in this case with a core diameter of 65mm (2 1/2") and to the length of the anchor; 3.2 metres (15ft) - Fig 1. The anchors were then installed with a plastic half pipe to facilitate their insertion - Fig 2. Finally the anchors were injected with 'Presstec' cementitious grout expanding them from their far end to the front. Although not essential, a flange-plate was also screwed to the exposed anchor end for additional securement - Fig 3.

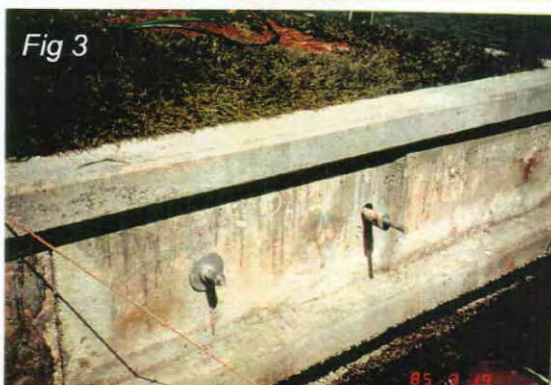

Department of Intercity Railways, British Rail
Railway Bridge 325 Abington/Carlisle Railway

Ground Anchor Stabilization

Cintec Ground Anchor Installation at bridge 325 Abington

INTRODUCTION:

Cintec International Ltd has developed a system of ground anchors incorporating the patented grout techniques utilised in the Cintec System of anchor fixings. The bridge section of the Civil Engineering Department of Intercity Railways, British Rail, permitted the installation of trail ground anchors through the abutments of bridge number 325 on the Edinburgh / Carlisle Railway line for testing.

GENERAL DESCRIPTION:

In general terms the anchors have the following features:

- a) A high tensile steel bar (ribbed type 2) forming the central element and load transferral mechanism to the abutment wall.
- b) The reinforcement bar has been epoxy coated to provide the first layer of corrosion resistance in accordance with British Standard for Ground Anchors BS8081: 1989.
- c) The corrugated sleeve of UPVC forms the second barrier against moisture and therefore corrosion resistance. The corrugations form a shear key to permit the transfer of forces from the ground to the central bar and then back to the structure.
- d) The elements in a,b and c above are within a polyester fabric sock which expands to contain the pressurised grout, the sock becomes formed to the shape of the cored or drilled hole. Plastic centralisers are used to ensure the correct positioning of the corrugation relative to the bar. Drawings and sketches are attached showing details.
- e) The grout forms the interlocking mechanism between the steel bar and the grout interface. The grout is a patented formulation developed specifically for anchor applications, it is delivered under pressure and is designed to obtain compressive strength capabilities of between 40 – 50 N/mm². Shrinkage is avoided by the use of additives premixed with the grout. The grout itself, being cementitious provides a highly alkaline protective environment against potential corrosion of the steel and the passage of moisture in the unstressed areas.
- f) The sock arrangement used in the trial anchors has features such that the remote end (that which is in contact with the soil) can be inflated independently of the near sock (that which is in contact with the structure). With this arrangement the remote end was tested in order to establish the load capabilities. After testing the outer sock was inflated to form the bond with the abutment structure.
- g) Relatively low steel stresses were involved in the anchor testing to eliminate unnecessary elastic extension and subsequential relaxation losses may be neglected.
- h) The outer sock forms a secure bond with the abutment structure thus avoiding the need for unsightly anchor heads visible on the outside.
- i) Each stage of the inflation process is monitored by a 'check sock', that is a small sock that inflates at the external end of the anchor indicating that the remote or unseen sock is fully inflated.

The anchor component parts and design with regard to corrosion resistance comply with the requirements of BS8081: 1989 the British Standard for Ground Anchorage for Permanent Anchors.

INSTALLATION:

From a scaffolded access platform, a mining barrel was used to core the hole through the abutment structure and into the embankment behind. The anchors were inclined at 20° to the horizontal beneath the bridge structure, and at 30° to the horizontal at wing wall locations. The anchors were inserted into the preformed holes and the two sections of the inner sock inflated. The grout is inserted at pressure from a pressurised container (89 PSI, 0.61 N/mm²). The outer sock was not inflated in order that each of the anchors could be subsequently be test loaded.

Sufficient time was permitted for the cementitious grout to cure before any load testing operations were carried out.

GROUND CONDITIONS:

The abutments are located either side of a vehicular access route through the railway embankment. The embankment was built approximately 100 years ago from nearby materials and consisted of gravel, sands with clay and silt. Given the soil profile found, the behaviour of the anchors would inevitably be unpredictable and large resultant test loadings were not anticipated.

TESTING:

The testing was carried out using a hydraulic jack with a calibrated dial gauge measuring the tensile load applied in tonnes. Each of the anchors was tested with the resulting loads tabulated in the following tables. The loads were applied in 4 tonne increments with a minimum of 10 minutes between each rise in the load. Several of the anchors were left for extended periods at the higher loads which coincided with the limit of the testing equipment. One anchor number 2 with the load applied overnight to see if any slippage had occurred. A small relaxation was apparent, although it could not be established if this was due to anchor creep or the testing apparatus deflecting. The location of anchors is indicated in drawing C2162/Sk 1.

The results obtained were of larger magnitude than could have been anticipated given the actual ground conditions. In general the loads obtained varied between 13 – 20 tonnes. The bond stress or cohesion at the soil / interface has been calculated to vary between 81.3 and 219.7 KN/m². Anchor number 1 has an unusually low value of 93.8 KN/m², however this particular hole was left exposed for some considerable time after the mining barrel was removed before the anchors were fitted due to an equipment malfunction which may have led to some localised collapse of the substrate. Anchor number 5 also has an unusually low bond stress of 81.3 KN/m², this anchor was inserted into the area of the sloping embankment, which would not have had the benefit of the loading consolidation as the area underneath the railway tracks. The remaining results varied between 140.6 to a maximum of 219.7 KN/m² which reflects the variable nature of the substrate.

As the sock is inflated under pressure with grout, it expands to fill the shape of the hole, thus filling any irregularities in shape and size. A combination of different factors is anticipated to develop the load capacities obtained as follows.

- 1) Forming an irregular wedge by the shape of the hole and sock inflation, thus creating the need to shear the soil in order for the anchor to fail.
- 2) The grout 'milk' extrudes through the sock and partially bonds to the surrounding granular material, thus enlarging the effective diameter of the anchor.
- 3) Localised compaction of the surrounding material due to the pressurised grout inflation.

The installation and testing was witnessed by:

Mr Kader of British Rail Intercity Civil Engineering Dept.
Mr Barnet of British Rail Intercity Civil Engineering Dept
Mr Dimmick of Cavity Lock Systems (now Cintec International).
Mr Parry of Cavity Lock Systems (now Cintec International).
Mr Woodhouse of Fordham: Johns Partnership.

The anchors were installed in the period February – May 1992 and tested between June 1992 and December 1992.

DESIGN OF ANCHORS:

The following outlines the basic principals involved in assessing the design parameters and considerations in relation to the capacity of the ground anchors.

STEEL TENDON

The steel tendon in the anchors tested comprised of a high tensile steel bar, (epoxy coated for protection).

The bar area was established by the formula:
$$\text{Area required} = \frac{\text{Load}}{F_y}$$

Where:- F_y = working load multiplied by an appropriate factor of safety (200Kn)
= characteristic strength of the steel (460 N/mm²).

For the test anchors, the area required = $\frac{200 \times 10^3}{460} = 434.8 \text{ mm}^2$

Bar diameter 40mm provides area of 1256 mm², F.O.S. = 2.88
Bar diameter 32mm provides area of 804 mm², F.O.S. = 1.85

The steel stresses in this case were maintained at the low levels shown in order to avoid significant elastic extensions and therefore potential relaxation losses.

The steel bar utilised in the tests was a high yield ribbed bar (type 2) which has raised ribs on the surface for increased bond capability.

The bond between the grout and the bar can be established from the equation:-

$$F_{bu} = B\sqrt{f_{cu}} \quad \text{where } f_{bu} = \text{the design ultimate anchorage bond stress.}$$

$$F_{bu} = 0.7\sqrt{40} \quad B = \text{coefficient dependent on type } (0.5 \times 1.4 = 0.7)$$

$$= 4.43 \text{ N/mm}^2 \quad f_{cu} = \text{compressive strength of grout } (40 \text{ N/mm}^2)$$

DESIGN OF FIXED ANCHOR LENGTH:

The pull out capacity of the test anchors can be shown as:- $T_f = \pi D L S$

Where S = the shear, bond and skin friction at Substrate/rock interface (Kn/mm²)

D = diameter of fixed anchor (m)

L = Length of fixed anchor (m)

T_f = pull out capacity in (Kn)

The values of S varied between 81.3 to 219.7 Kn/m². For design purposes the lowest value should be used and a factor of safety of 4 utilised to limit ground creep in permanent anchors.

For design of anchors at specific locations the nature and behaviour of the substrate must be established by testing. Full-scale load tests are recommended to confirm laboratory results.

FIXED ANCHOR DESIGN IN ROCK

$$T_f = \frac{\pi D L T_{ult}}{\text{Factor of Safety}} \quad \text{Where } T_{ult} = \text{the ultimate bond or skin friction at sock / rock interface.}$$

The value of T_{ult} will vary dependant on rock type, condition and discontinuities. A minimum fixed anchor length of 3m is recommended to account for local variations and a factor of safety of 3 to 4 be applied dependent upon the circumstances of usage.

FIXED ANCHOR DESIGN IN COHESIONLESS SOILS

The substrate at the testing location falls into this category although clay and silts were present.

$$T_f = \frac{\pi D L S}{\text{Factor of Safety}}$$

The value of S must be found by testing. A factor of safety of 4 should be used and a minimum length of 4m is recommended.

FIXED ANCHOR DESIGN IN COHESIVE SOILS

$$T_f = \frac{\pi D L \alpha C_u}{\text{Factor of Safety}} \quad \text{Where } \alpha = \text{adhesion factor } 0.3 - 0.45 \text{ verified by testing.}$$

$$C_u = \text{average undrained shear strength of substrate.}$$

The value α and C_u must be found by laboratory tests or full-scale tests. The factor of safety should be of the order of 3 to 4 and a minimum length of 3m is recommended dependent upon consistency.

ANCHOR BOND TO STRUCTURE

Should the anchor be required to bond to the structure (as opposed to an anchor head arrangement) the following equation may be used:-

$$T_s = \frac{\pi D L B}{\text{Factor of Safety}} \quad \text{Where } T_s = \text{ultimate bond to the structure material (Kn)}$$

$$B = \text{bond between sock and structure (Kn/m}^2\text{)}$$

The value of B will vary dependent upon material, values of 600Kn/m² are reasonable (subject to testing) for solid concrete or masonry.

DISCUSSION

The general conditions at each location will dictate the design stresses to be used in assessing the ultimate capacity of an individual anchor. Where laboratory tests are not available, full-scale insitu tests are required to establish the lower bounds of the substrate capacity.

A minimum fixed anchor length of three metres is recommended to account for local variables in substrate conditions.

In order to reduce the possibility of long term ground creep, factors of safety should be applied. These factors should be of the order of 3 to 4 dependent on soil consistency, life expectancy and their importance to the structure.

The fixed anchor length must be located beyond the critical zone, such as the wedge failure, slip circle, rock discontinuities in order to be effective. The free anchor length will depend upon the geometry of the location.

The anchors can act as a restraint, only accepting load if movement occurs, or they can be pre-stressed to a set load to provide an active force.

A feature of the Cintec System is that a choice of connections can be achieved with regard to fixing to structure. Traditional anchor head details may be used where periodic re-stressing or monitoring is required. Where the structure is suitable, the anchor may be bonded to the material as a permanent fixing, without the requirement for surface apparatus.

GENERAL DESIGN CONSIDERATIONS

Where ground anchors are being utilised, careful consideration should be given by the designer to the following points:-

- a) Detailed field and laboratory tests to establish soil characteristics.
- b) Full-scale load tests to confirm laboratory predictions.
- c) Assessment of consequences of potential long-term creep.
- d) Overall length of anchor, fixed anchor length, failure planes.
- e) Effects of anchor groups if anchors closely spaced.
- f) Likely stress losses due to tendon relaxation.
- g) The free anchor length can be released from the grout by use of smooth tubes forming the second barrier of corrosion resistance, thus avoiding stressing ground close to structure.
- h) The factor of safety to be applied.
- i) Reference should be applied to the British Standard BS.8081 : 1989 or other appropriate document for advice on usage and design.

CONCLUSION

The testing of the ground anchors showed that the Cintec System could be successfully used in even the most difficult of ground conditions and achieve results in excess of expectations.

Careful appraisal of all factors must be given by the designer, to the points raised in the design considerations section, in order to fully realize the potential of the system.



S. WOODHOUSE B. Eng (Hons) C.Eng M.I.Struct.E.

23rd APRIL 1993

Date: April 1993 Scale: / Drawing No: C2162/Sk 1
 Drawn: J.S. Design S.W. Project: BRIDGE 325, ABINGDON
 Drawing Title: GROUND ANCHOR DETAIL TO ABUTMENTS

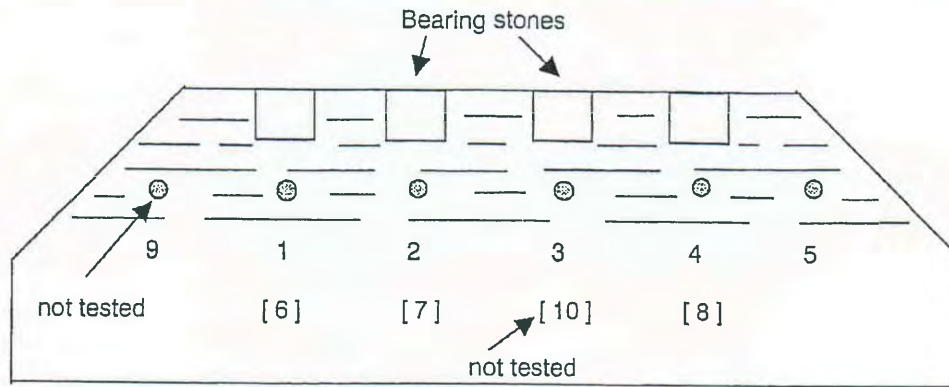

ELEVATION OF NORTH & SOUTH ABUTMENT SHOWING GROUND ANCHORS
SOUTHERN ANCHORS 1 – 5
NORTHERN ANCHORS 6 - 8

ANCHOR NUMBER	ANGLE OF INCLINATION	TOTAL LENGTH (M)	FIXED ANCHOR LENGTH OR LENGTH OF EMBEDMENT (M)	HOLE DIAMETER (MM)	TEST LOAD [T]
1	20°	5.45	4.1	124	15
2	20°	3.95	2.6	124	18
3	20°	3.45	2.1	124	18
4	20°	3.95	2.6	124	19
5	30°	5.45	4.1	124	13
6	20°	4.45	3.1	124	18
7	20°	4.45	3.1	124	17
8	20°	4.95	3.6	124	20

Date: April 1993 Scale: / Drawing No: C2162/Sk 3
 Drawn: J.S. Design S.W. Project: BRIDGE 325, ABINGDON
 Drawing Title: GROUND ANCHOR TEST RESULTS

Anchor number	Angle of inclination	Total Length (m)	Fixed anchor length or length of embedment (m)	Hole diameter (mm)	Soil anchor interface (mm ²)	Test Load (T)	Test Load (KN)	Shear stress Soil / anchor interface (N/mm ²)	Shear stress soil anchor interface (KN/m ²)
1	20°	5.45	4.1	124	1.599x10 ⁶	15	150	0.0938	93.8
2	20°	3.95	2.6	124	1.014 x10 ⁶	18	180	0.1775	177.5
3	20°	3.45	2.1	124	0.819 x10 ⁶	18	180	0.2197	219.7
4	20°	3.95	2.6	124	1.014 x10 ⁶	19	190	0.1873	187.3
5	30°	5.45	4.1	124	1.599 x10 ⁶	13	130	0.0813	81.3
6	20°	4.45	3.1	124	1.209 x10 ⁶	18	180	0.1488	148.8
7	20°	4.45	3.1	124	1.209 x10 ⁶	17	170	0.1406	140.6
8	20°	4.95	3.6	124	1.404 x10 ⁶	20	200	0.1424	142.4

Date: April 1993

Drawn: J.S.

Drawing Title: GROUND ANCHOR DETAILS

Scale: /
Design S.W.

Drawing No:
Project:

C2162/Sk 2
BRIDGE 325, ABINGDON

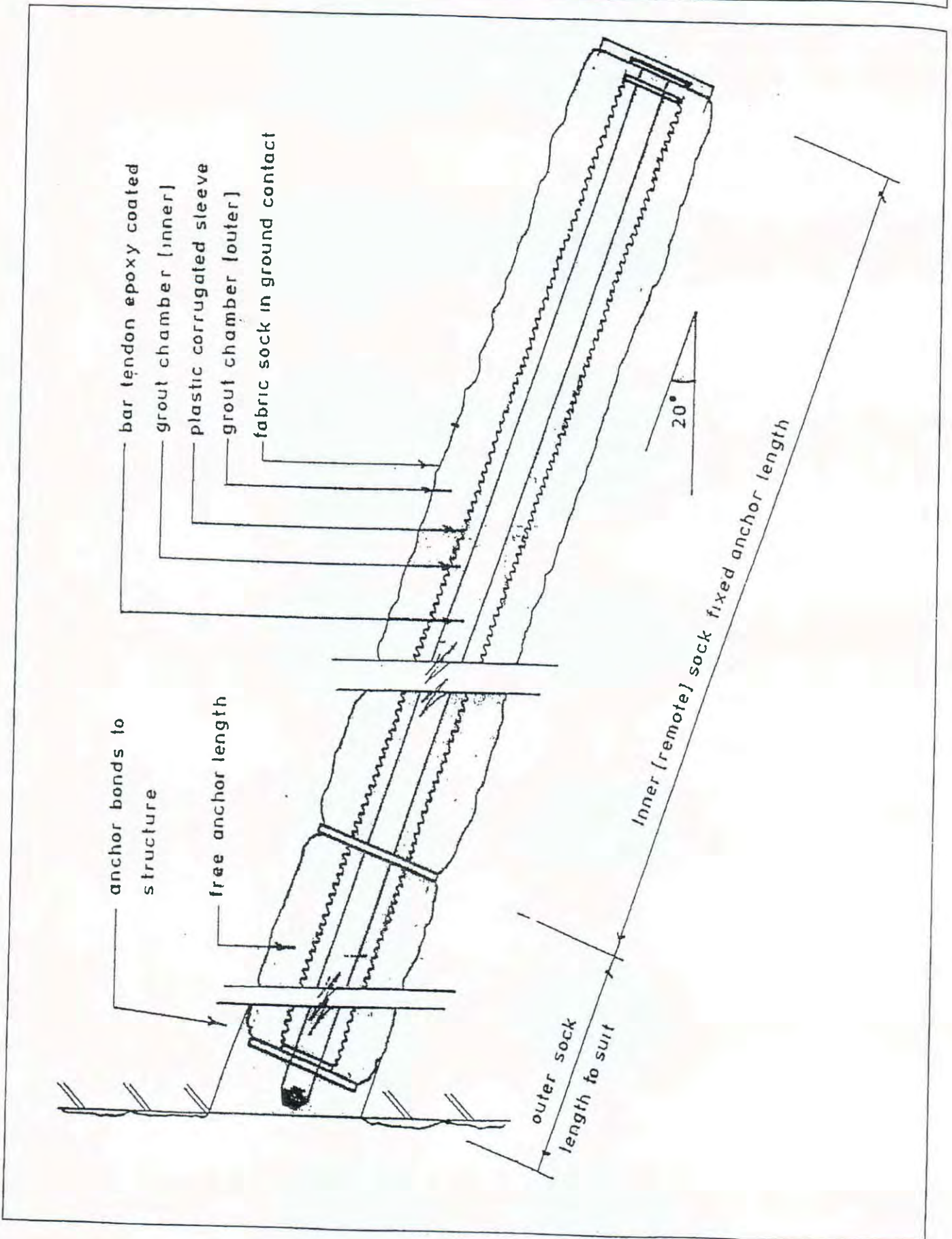



**Installation of Ground Anchors
Through Railway Bridge Abutment**



Obj. Wülzburg

STÜTZWAND SCHNITT

Darstellung
unmaßstäblich

TEILANSICHT

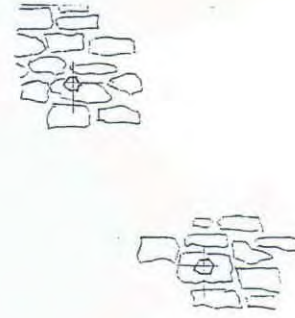
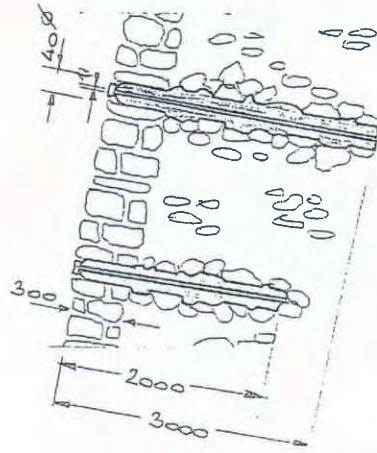

SCHNITT durch STANDARDANKER System C=INTEC-MC

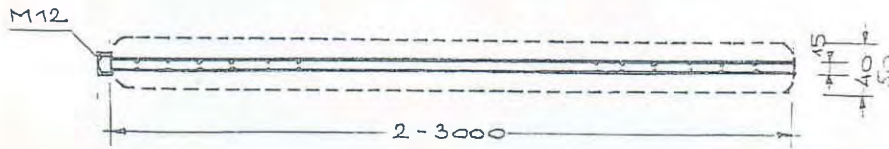

SCHNITT durch DOPPELROHRANKER System C=INTEC-MC
Ausführung RAC 10 X 1 mm.

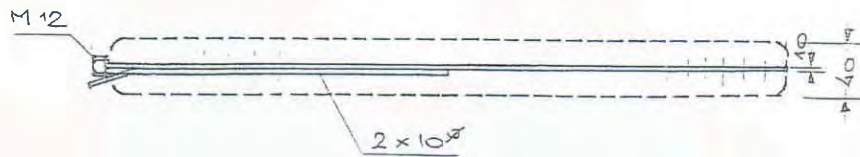

CINTEC tools, stitching anchor installation & injection



Corner, drilling for small stitching anchors, Grout mix





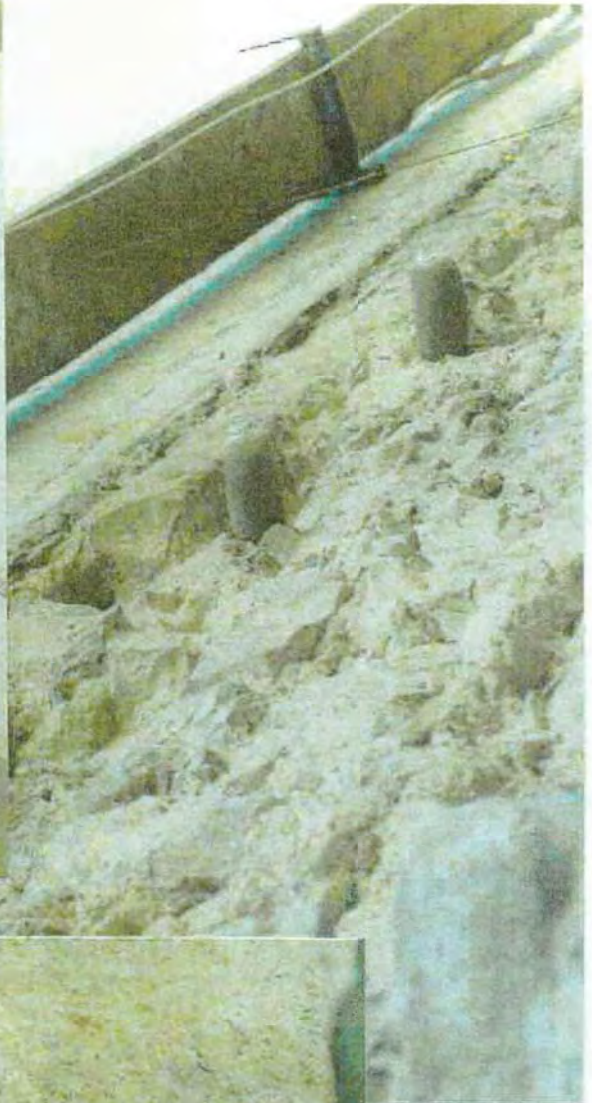
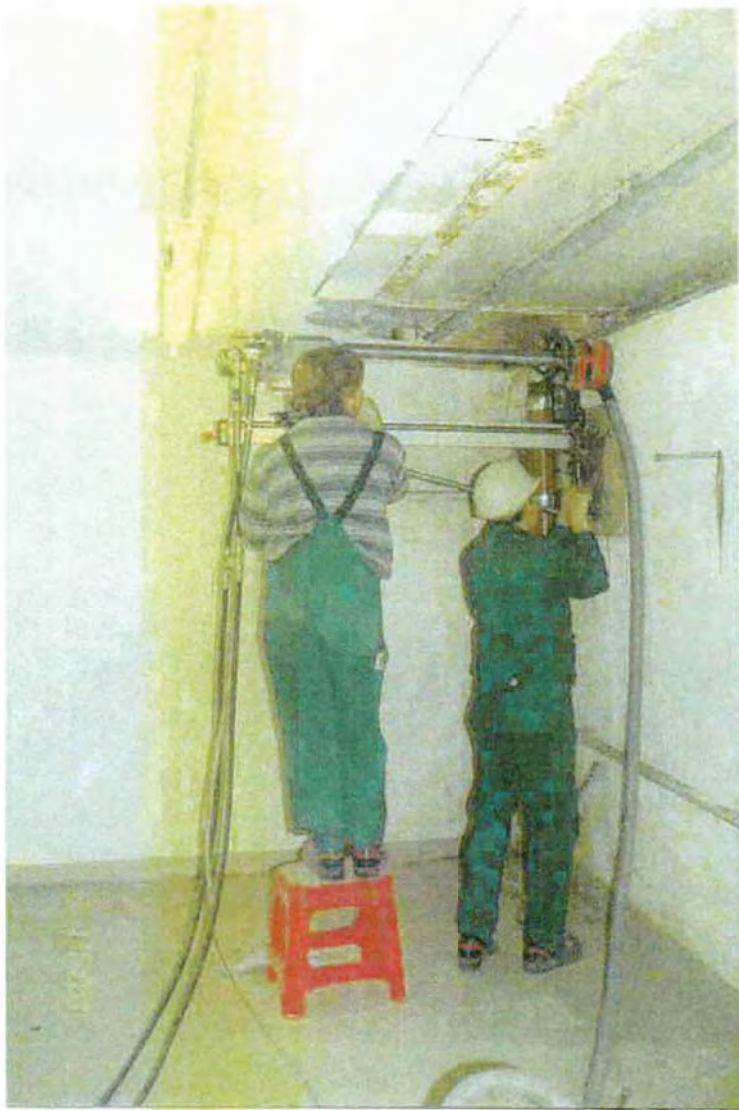





CASE HISTORY

BLAENAVON IRONWORKS SOUTH WALES (UK)



The furnaces at Blaenavon were built in 1788-89, and by 1796, were the second largest ironworks in Wales until its demise in the 1880's. It is now in urgent need of attention, CADW, responsible for the renovation of Welsh historic monuments, are involved in a programme of restoration to the main furnaces at Blaenavon.

A series of anchors have been installed to support the delicate structure to allow access for repairs and refurbishment.

A digital 3D model has been produced for the engineering team responsible for stabilisation of the structure. Working in very difficult conditions the team collected data to produce 3D elevations of all the faces of the furnace.



Drawing by Sir Richard Colt Hoare from Cox's Tour in Monmouthshire 1799 – Courtesy CADW

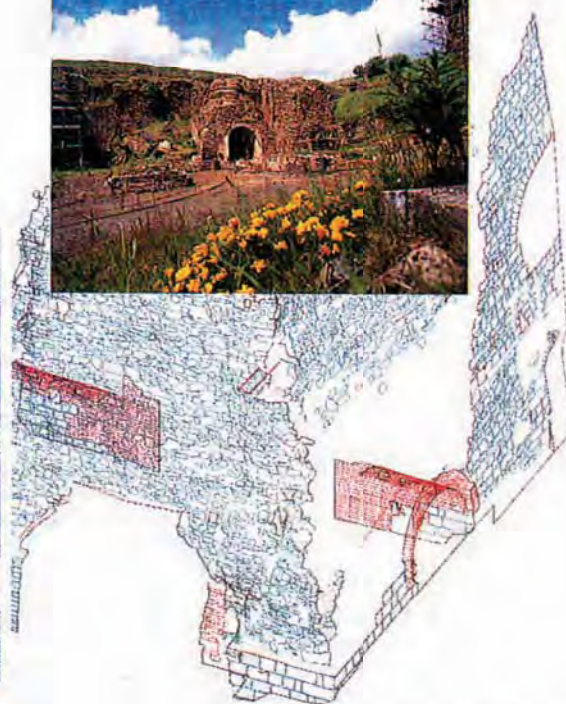

Drawing: Plowman Craven & Associates (Tel. 01582 765566)
Photo: Welsh Historic Monuments, CADW

CASE HISTORY

WORLD HERITAGE SITE BLAENAVON IRON WORKS SOUTH WALES (UK)



Conservation of Blaenavon Ironworks in South Wales continues to rely on Cintec anchors to solve the problem of stabilising walls of unknown and inconsistent structure.

The 2003/4 phase of conservation of this historical industrial site involves both the stabilising of retaining walls and the strengthening of an adjacent Gas Tunnel built into the hillside behind the site's five furnaces.

The cylindrical brick gas tunnel in Work Area 2 runs behind the furnace bank wall at a height of about 10 metres from the ground. An old collapse of a section of the wall left the broken remains of part of the tunnel in a precarious state on the steep slope. The tunnel was originally supported on iron plates and cylindrical bars spanning onto stone masonry walls. However with much of the outer support wall now missing, the tunnel was left with little obvious support and was unsafe to access from below.

The first stage of conservation involved the installation of Cintec anchors through the brickwork of the tunnel into stone masonry and the embankment behind, to support the weight of the tunnel. The anchoring operation allows safe access to be achieved from below, for the rebuilding of the support masonry. The instability of the remains precluded access from below, and roped access from above was the specified method of installation.

The exact composition of the tunnel remnants and interfacing wall structures was unknown. Initial drilling of cores for the anchors confirmed that the 200+ year old structures were riddled with voids and an inconsistent mix of stone masonry, clay and coal. The fully encapsulated design of the Cintec system offered the most efficient way of stabilising these wall conditions. By containing the grout, the Cintec sock ensures none is lost and there is no undesirable migration into other parts of the structure. An optimum amount of grout is taken up into the sock in achieving a sound, continuously embedded structural solution in the

wall, regardless of voids. This effectively binds together all of the various materials penetrated, resulting in good cohesion and consolidation.

A double mining barrel, with an inner and outer sleeve, was used in areas where drilled cores could collapse before reinforcing members could be introduced due to the instability of the wall materials. The outer sleeve then creates a rigid conduit for the inner sleeve to work through, allowing core to be extracted to the required depth. With the outer sleeve still in place, the inner sleeve is removed and the Cintec anchor system inserted. The outer sleeve is then withdrawn before the anchor is permanently bonded into position with injection of grout into the Cintec sock.



A total of 29 deformed round bar stainless steel anchors, measuring 20mm diameter and 4m long, were used in this stage of conservation. A further combination of 8m long consolidating stitching anchors, 30mm by 30mm by 3mm SHS (square hollow section), and ground anchors approximately 11m long, were also used near the water tower.

The Cintec system is approved by The National Trust, English Heritage and Cadw for the restoration of all types of listed and protected structures.

CASE HISTORY

Nantgarw Pottery Works Wall - Glamorganshire, South Wales, U.K.



Insertion of 3m Cintec Anchor (left). Its inflation using cementitious grout, (above).

Nantgarw pottery rivaled that of Swansea in the 17th Century for its high quality earthenware, in recognition of its historical importance, the local authority wished to restore one of the now derelict bottle kilns. The location of the proposed rebuild kiln was immediately adjacent to an ancient stone retaining wall. The 2 meter high wall was constructed from random rubble using local stone and was bedded and jointed using black ash mortar. There was concern that this wall would not withstand the additional imposed loading from the rebuilt kiln.

The structural engineers, ove arup working in conjunction with protechahome, opted to specify Cintec ground anchors to stabilize the wall and provide resistance to the additional horizontal forces imposed by the kiln.

Cintec ground anchors were installed horizontally through the bed joints and into the ground infill retained behind it. This infill comprised mainly of broken brick, stone, clay, pottery shards and other assorted material. The core drilling technique employed to create the holes also revealed many voids within it, a significant feature of the Cintec anchor is its ability to bridge such gaps by retaining the flow of grout with its polyester sleeve. The 3 meter long Cintec anchors were installed at 1 meter horizontal intervals and tested to a working load of 15kN each.



The process of diamond drilling (above). With the subsequent core samples produced, (left).



CASE HISTORY

THE RESTORATION AND STABILISATION OF THE BLISTS HILL FURNACES, TELFORD, ENGLAND, U.K.

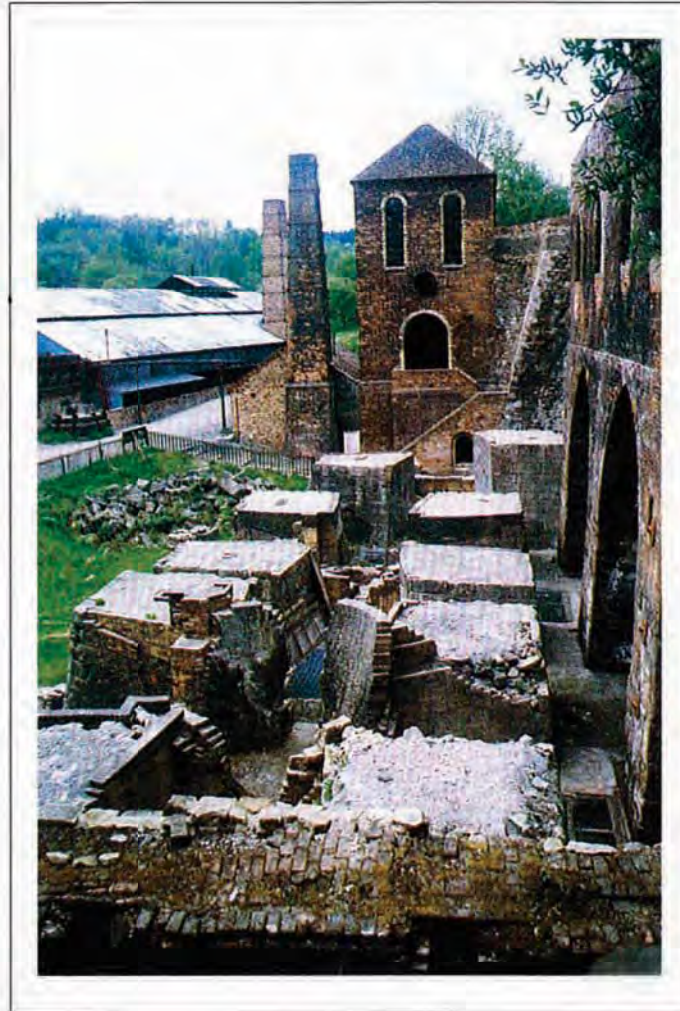

Introduction

The repair and restoration of the Blists Hill Furnaces, which form part of the Blists Hill Open Air Museum Site near Ironbridge, Telford, has recently been completed. The works were instigated as part of a major repairs programme designed to renovate and restore, numerous structures within the Ironbridge Gorge Heritage site.

A detailed repair schedule was prepared for each of the sites by a working party, including architects, civil and structural engineers, surveyors and archaeologists and the work funded by the Department of the Environment.

The purpose of the repair work was to restore and renovate the properties and structures to an acceptable condition whereby the ownership and future maintenance of the structures would pass into the care of Ironbridge (Telford) Heritage Foundation.

In order to bring about the restoration and stabilisation of the Blists Hill Furnaces, it was necessary to undertake remedial work on the existing brickwork and stonework, together with the introduction of extensive ground anchors and tie bars.

Work required to prevent further ingress of surface ground water into the furnaces was undertaken as a separate, but integral, phase of the works.

CASE HISTORY

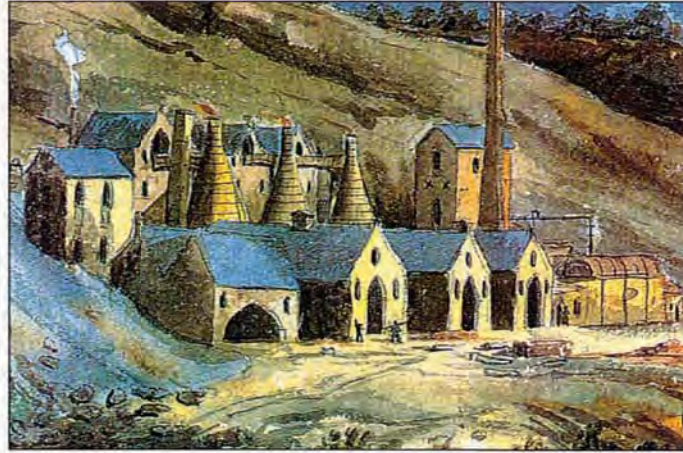

Background history *

The Madeley Wood Company was formed in 1756 when the ironworks at Bedlam, one mile west of Blists Hill, on the River Severn, was founded. The Bedlam Furnaces were owned by this company, which held mineral leases in Madeley Parish, enabling it to extract coal and iron ore. Upon its opening in 1790, the Company had access to the Shropshire Canal, the Blists Hill section of which ran immediately to the east of the Blists Hill works site. Proximity of raw materials and the means of transporting the finished product persuaded the Company to build a blast furnace at Blists Hill in 1832.

Additional furnaces were added in 1840 and 1844, making a total of three, and the site remained active in the production of pig iron until 1912, when the ironworks ceased production, following the blowing in of two of the furnaces.

The site history through the 20th century is less well documented. Dense vegetation cover was allowed to establish itself amongst the ruins until the late 1950s when the site was subject to spoil dumping which completely buried the furnace bases. In the 1970s the Ironbridge Gorge Museum Trust began clearing and restoring the works.

Structural defects

The buildings had fallen into poor repair due to the ravages of time and ingress of ground water. This dereliction and general instability of the furnace structures represented a hazard to the preparation of a specification for the repair. It was, therefore, necessary to undertake the design and installation of an extensive scaffold propping scheme to enable the facade of the structure to be stabilised sufficiently to enable the appraisal and detailing of repair work.

The scale of works was restricted due to the nature, historical and archaeological importance of the site. Problems were encountered during the design stage of the scheme due to the presence of many underground tunnels and chambers which linked the furnace bases back to the main engine houses.

By buttressing the supporting scaffolding back onto the old furnace bases, and utilising heavy concrete blocks as kentledge, sufficient dead weight was applied to stabilise the temporary propping. Prior strengthening of the furnace bases was required to ensure that the high loads from the buttresses could be transferred to the sub-strata without distressing the superstructure.



Drilling



Restoration work in progress

CASE HISTORY

RESTORATION & STABILISATION OF THE BLISTS HILL FURNACES, TELFORD, ENGLAND, U.K.

Following completion of the propping scheme a detailed visual and photographic inspection of the site structures was undertaken to ascertain and record the condition of the walls and to determine the cause of the damage, enabling the formulation of a repair and stabilisation strategy. This appraisal concluded that the damage which had occurred could be generally summarised as follows :

- Superficial damage of the masonry and stone walls cause by the presence of vegetation and water ingress. This was most evident at the top of the structure, where significant loosening of the brick and stonework had occurred with subsequent loss of the retained material. Water penetration, in conjunction with frost action, was also causing significant deterioration to the fabric of the brickwork and stonework.
- Differential settlement in the south wall of the south furnace charging building resulting in westward rotation of part of the wall and consequent vertical and diagonal cracking through the superstructure supported by it.
- Cracking and spreading movements in the superstructure, resulting in outward displacement of walls.
- Distress cracking, loss of material and localised collapse of the stone masonry retaining walls which were up to 13m high.

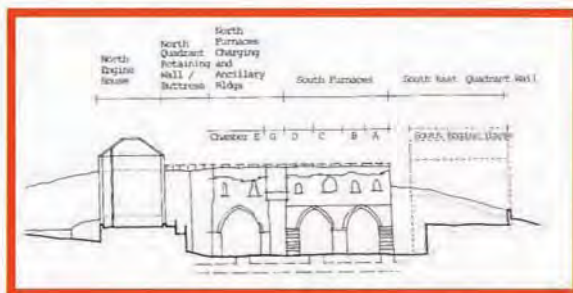

West elevation

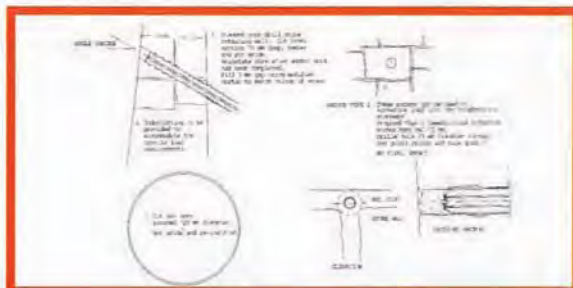

Making good anchor holes in stonework

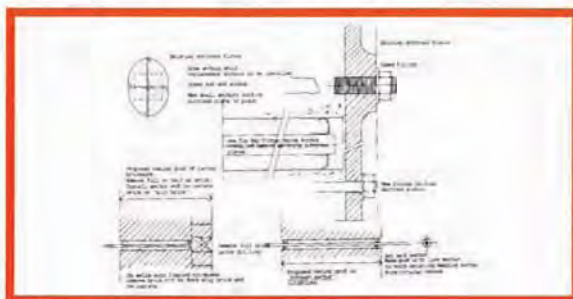

Making good anchor holes in brickwork

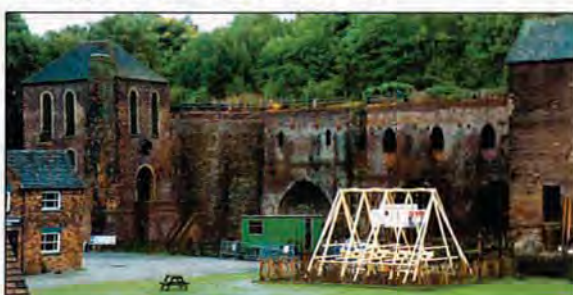

Completed renovation

The geology of the retained ground was investigated, using shell and auger holes, with subsequent laboratory tests to determine the characteristics of the subsoils. The investigation concluded that the site is overlain with topsoil on fill materials form 6 -11 m deep. The fill is principally ash containing one or more of brick and tile discards, blast furnace slag and coal. It is deposited on mudstones containing strata or lenses of sandstone and hard clay. The mudstone at the fill interface is frequently softened to a medium clay due to weathering caused by the presence of ground water.

Rates of deformation and crack development

Since the excavation of the structure in 1980, a number of structural movements appear to have taken place, as evidenced by cracking and distortion of early repairs undertaken by the Ironbridge Gorge Museum Trust. No long term records exist, but during the preparation of reports for the repairs brief, it was visibly noticeable that movement and cracking was worsening, confirming that it was progressive.

In addition to this cracking, rusting of the cast and wrought iron plates, lintels and tie bars within the structure was continuing, due to the ingress of ground water, with a consequent splitting and heaving of masonry. This in turn caused increased water penetration to the structure.

Remedial measures

Following detailed discussions with English Heritage, a series of remedial measures to stabilise the structures was proposed. This work included the general consolidation of voided and eroded brickwork and stonework in conjunction with the installation of new tie bars and ground anchors. The selection of the ground anchor and tie bar was the subject of careful consideration, due to the very significant archaeological and historical importance of the structure.

CASE HISTORY

Concern was expressed that any grout used in the anchoring works should not be allowed to penetrate areas of the structure in an uncontrolled fashion.

The Cintec Anchors provided not only the correct structural solution to the problems but also enabled the work to be undertaken in a controlled manner, with the grout restricted to only those areas around the anchors where it was structurally required. The Cintec Anchors were used to replace the eroded and rusted tie bars, in addition to their use for the ground anchorage work on the project.

Careful consideration and planning was undertaken by the design team in conjunction with the specialist sub-contractor so that all the anchors and ties were installed with minimal visual disturbance to the building structure, not only during installation but also upon completion of the work. The ground anchors were required to sustain a maximum safe working load of 60kN and this was achieved by socketing the Cintec Anchors a minimum of 3.0 m into the mudstone strata.

The ground anchor installation required a 100 mm diameter core to be taken out of the centre of a selected stone within the retaining wall. Drilling was then undertaken with or without a steel casing, using an air flush drilling system, to a designed anchor position and length of embedment into the underlying mudstone. The anchors were installed at a downward angle in order to reduce the depth of drilling necessary to penetrate the mudstone. Even with this angular adjustment the length of the Cintec Anchors was in excess of 20 m. The Cintec Anchor was then inserted in the hole with the sock positioned around the anchor. The whole anchor was then pressure grouted to within 100 mm of the face of the wall. Finally the original core was refitted into the core hole and resined into position so as to mask the end of the anchor.

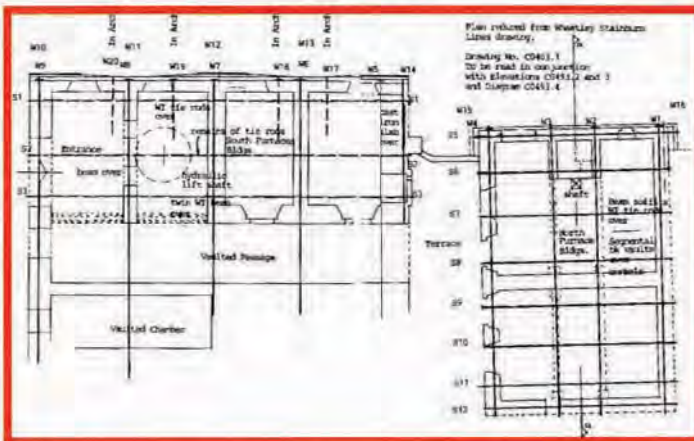

Setting out anchor/tie bars

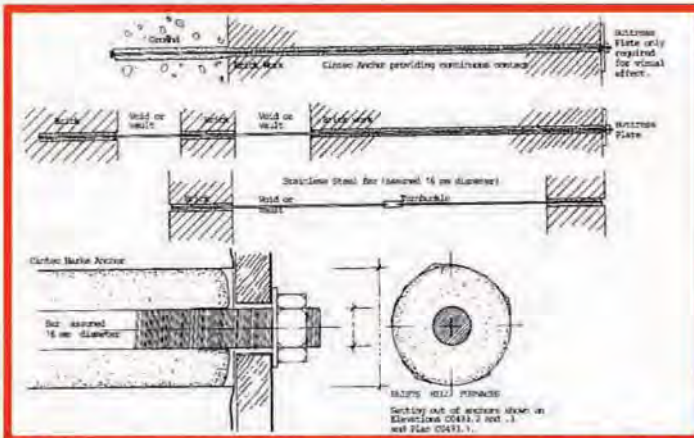

Application of tie bar system with Cintec Anchors covering the south and north furnaces and north engine house.

enabled the stabilisation and renovation of this very important archaeological and historical structure to be achieved. The anchors were able to satisfy the necessary structural criteria whilst enabling all the operations to be fully controlled, thus producing only a nominal visual and archaeological impact on the structure which remained apparently unaltered.

Where necessary, due to the location of the anchor within the wall and the adjacent stones, the insertion of small diameter stainless steel needles, secured by epoxy resin was undertaken. This 'stitched' the area around the anchor together. Generally a Cintec RAC 10 mm diameter anchor was employed with the anchors positioned into the bed joints of the stone retaining wall. In most cases 5 Cintec RAC anchors were installed around each ground anchor position.

Within the south and north furnaces where vault tie bars were to be replaced, the use of the Cintec Anchors was once again adopted. The new ties were inserted adjacent to the locations of the existing patress plates initially removed to enable drilling to take place. The anchors were installed in 50 mm diameter holes cored through the brickwork and where necessary into the mudstone strata behind the structure. The anchors and socks were inserted and grouted within the brickwork/mudstone, leaving the exposed areas of tie bar clear of any grout. The existing patress plates were re-fixed in their existing position so as to mask the repair works and leave the structural appearance of the building apparently unaltered.

Conclusions

The use of the Cintec sleeved anchors has

CASE HISTORY

Blaise Castle Estate, U.K

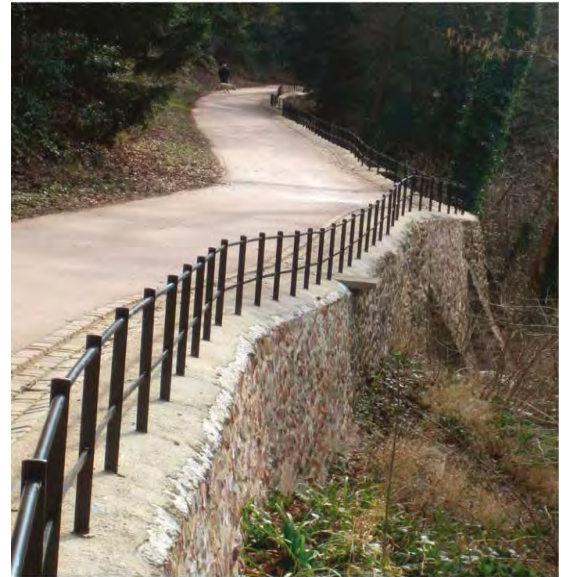

Ground Anchoring

The Blaise Castle Estate is 650 acres of parkland consisting of a deep wooded lime stone gorge, dramatic scenery and a number of historical monuments including a folly castle (above) built in 1766 as a summer house within the perimeter of an Iron Age hill fort. The park also boasts an extensive range of scenic pathways offering views of natural and historical interest.

In the autumn of 2004 and under the project management of Mann Williams (Bath), remedial work was undertaken along one such stretch of pathway, the requirement being to strengthen and stabilize the supporting retaining wall below. The diamond core drilling and anchor installation was contracted to Falcon Structural Repairs of Portishead (Bristol). In total No 232, 16mm diameter x 4500mm long 304 stainless steel rebar anchors were installed into 65mm diameter drill holes. Each anchor was fitted with a 150mm wide front plate and recessed partially into the wall and subsequently No200, 10mm diameter x 600mm long RAC anchors were also installed to consolidate the structural stonework of the retaining wall itself.

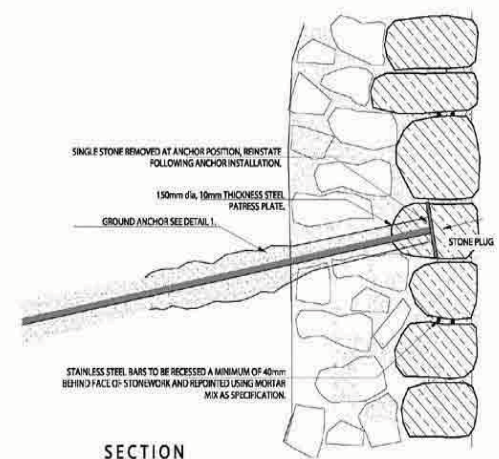

CASE HISTORY

Goodrington Sea Wall, Devon, U.K.

The Sea wall at Goodrington Beach, in Devon, UK, was constructed of local stone and founded upon a concrete footing. The whole wall was gradually moving towards the sea by sliding off the concrete foundation

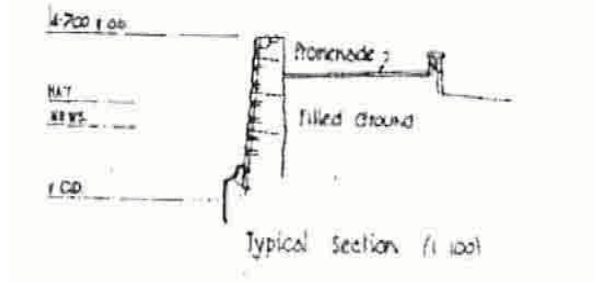

To overcome the problem, Torbay Borough Council proposed a design using Cintec anchors to pin the wall to the foundation. The anchors were inserted at an angle to mobilize the full length of the wall.

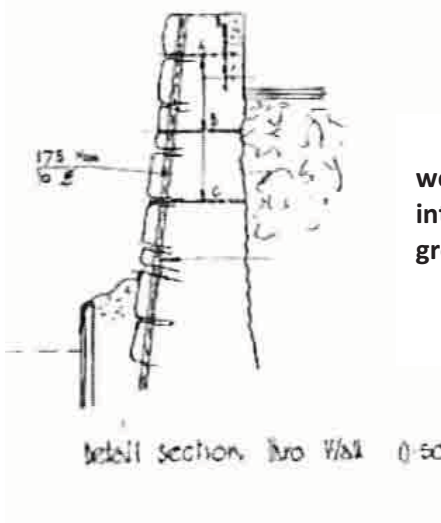
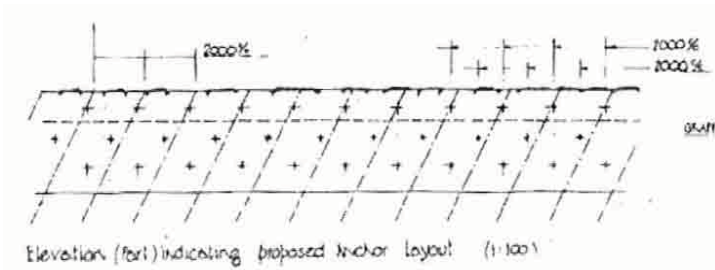

Additionally Cintec consolidation anchors were inserted on a regular grid to ensure the integrity of the wall and the action of the ground anchors on the wall.

All anchor sockets to be grouted using 'rescrete' high strength grout

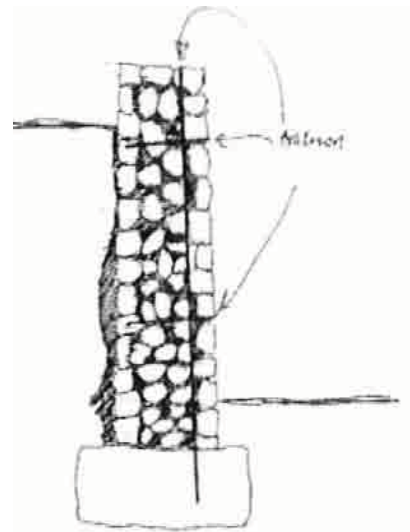

Malmesbury Town Wall



The 12th Century Town Wall at Malmesbury in Wiltshire is being restored as part of an ongoing conservation project involving the Conservation Department of North Wilshire District Council in conjunction with English Heritage.

The random rubble wall is constructed from locally quarried limestone up to 1.50 metres in thickness, however erosion of adjoining earth and the effects of time had taken their toll resulting in localised delamination and rotation

In order to maintain the structural integrity of the wall, English Heritage advised the specification of Cintec ground anchors for a number of phases for the work.

Stability was returned to the wall by inserting Cintec ground anchors through the thickness of the wall and into the clay and limestone behind.

Diamond drilling (right) and anchor insertion (below).



The anchors were installed through the joints of the stonework following the completion of gravity grouting of extensive voids within. To facilitate this process, clay was used to seal the open joints between the stones in order to retain the original historic grouting. This was later removed and the wall pointed with lime mortar to match the original material.

The Cintecground anchors were tested to a working load of 15kN. Other, smaller Cintec anchors were also used for wall consolidation.

CASE HISTORY

Malmesbury Church Street Rotation, U.K



As can be seen from above photograph this retaining wall has seriously rotated towards the next property. Understandably the neighbors were becoming extremely concerned about its safety. The wall retained the garden and some imposed load from the house foundations.



Engineers Mann Williams devised a scheme to save the situation by installing Cintec ground anchors through the wall at one-third height together with vertical Cintec anchors to reinforce & mobilize the full height of the wall to resist the rotational effect. Anchors were located as shown by dotted red lines.

CASE HISTORY

Lock Gates Clarendon Docks, Belfast, U.K.



Clarendon Docks

Cintec anchors have been used to fix two 20 ton lock gates, as part of the 750 million pounds sterling, regeneration of Belfast's Laganside Development.

Clarendon Docks, where shipbuilding in Belfast first commenced, was severely affected by the river's tidal range. Construction of a temporary dam across the existing dock basin, and installation of a lock between the basin and the river, has created an aesthetically pleasing non-tidal water feature capable of facilitating small craft.

Although the dock basin was pumped dry for the refurbishment of the waterfront site, it was vital that the fixing method selected was suitable for use underwater.

Each gate is supported by two hinges bolted into the 600mm concrete wall of the lock. One of the key reasons for selecting the Cintec system, was that although the top hinge for each gate is well above the water level, the lower hinge falls within the tidal zone, "explained Brian Campbell, Design engineer for the installers.

During the installation, sea-water poured through at one of the anchor locations. We were concerned that alternative fixing methods would not be as successful in such wet conditions."

Following extensive testing, 48 Cintec anchors were embedded into the wall to support the two lock gates. Each lower hinge required 12 fixing anchors, 450mm in length and 102mm in diameter at 200 and 220 centers.

The installation of the anchor bolts at the lock gates has been undertaken by ACE Fixings, the approved installers of Cintec anchoring system for Ireland.

CASE HISTORY

Hay's Dock Lerwick (Shetland Islands) - Scotland



Panorama of Hay's Dock with the Heritage Centre under construction in the background (right), the restoration of the old sail house on the quay (centre right) and Cintec stablisation work (end of the quay left of sail house).

Lerwick is the capital of the Shetland Islands and in the early 1830's became a thriving centre for the herring industry. The foundation for this commercial success lay with the construction of Hay's Dock and a complex of warehouses and curing yards together with all the facilities for building and rigging sailing vessels. The fortunes of the herring industry fluctuated considerably during the 19th century and as vessels became larger and steam power became the norm, a new larger facility was required and subsequently built by the Lerwick Harbor Trust in 1906. The original dock continued to play an important commercial role adapting primarily to the timber trade.

Today Hay's Dock stands as a monument to the town's industrial heritage and with the assistance of the Shetland Amenity Trust, Historic Scotland and a contribution of lottery funding, the dock area is being rejuvenated with the construction of the new Shetland Museum and Archives building as well as the refurbishment of the old docks itself.

When originally constructed, technology for building underwater was limited. Consequently the foundations of the furthest and hence deepest part of the quay consist of large stone blocks resting upon a layer of relatively unstable sand and gravel. Inevitably, over the last two centuries, the structure has suffered from significant subsidence.

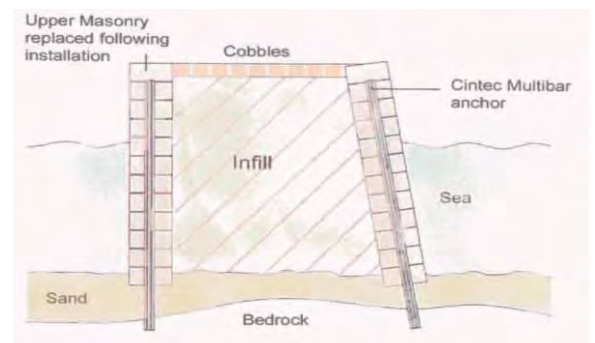

CASE HISTORY



Consulting Engineers Elliott & Company proposed a solution for installing Cintec anchors to both secure the individual blocks of stone masonry and also to underpin the whole structure to the bedrock below. 18 Cintec Multibar anchors were installed by the drilling contractor Holequest Ltd, each anchor being five meters long and consisting of four strands of 16mm diameter 316 high grade stainless steel rebar in square formation. A drill rig was used to diamond bore each 150mm diameter hole prior to the installation of the mulibar anchors. The two man cycle of drilling and installation proceeded at a rate of one anchor extremely variable weather even in the month of June.

High grade stainless steel was chosen to improve the long term resistance to the corrosive effects of the salt water. Before installation, the polyester sock of each anchor was completely saturated in fresh water, not only to facilitate the injection and inflation of the anchor, but also to provide a temporary barrier between the reinforcing bars and the external sea water. The low pressure injection of the cementitious grout expanded the anchors from the far bedrock end upwards and so displaced any sea water within the drilled holes and locking the anchors were installed, the original surface edge stones and inner cobbles were placed back into position, concealing the stabilisation work beneath.



A mobile rig was employed firstly to core drill the anchor holes, then to temporarily install a metal tube hole lining, following by the lifting and lowering of the Cintec anchor (above) and finally the removal of the temporary core lining prior to anchor injection

CASE HISTORY

HOLY AUSTIN ROCK – KINVER, STAFFS, ENGLAND, UK

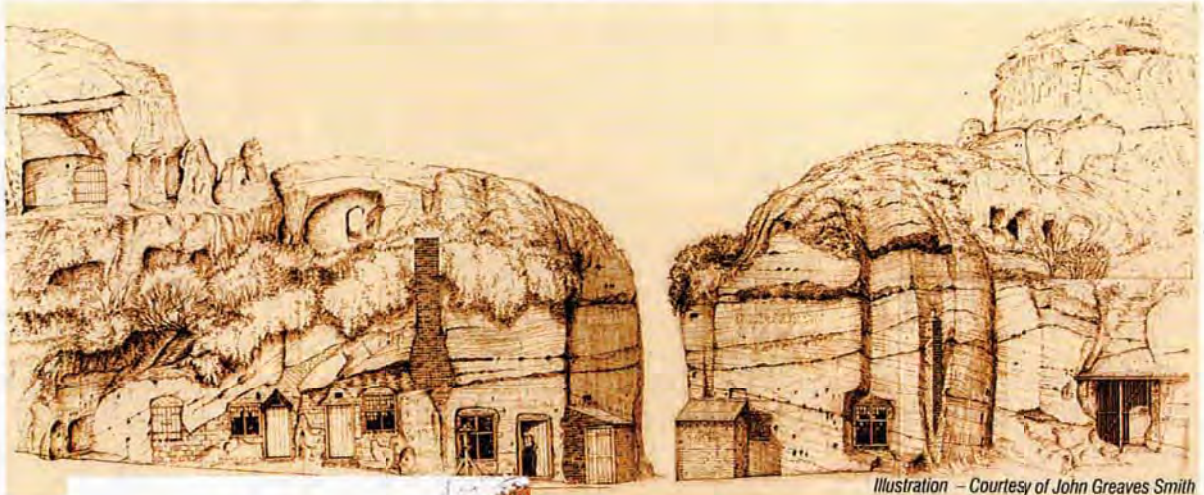

Illustration – Courtesy of John Greaves Smith



External view of main entrance to restored dwelling.



Internal view of front room, above cave.

RESTORATION OF THE LOWER CAVE DWELLINGS AT HOLY AUSTIN ROCK, KINVER EDGE

The Name 'Holy Austin' is said to be after a hermit who lived near the site during the 16th century. This is the earliest known reference to the occupation at Holy Austin rock.

In May 1993 the National Trust completed the first phase of restoration in their imaginative scheme to restore the nationally important cave dwellings at Kinver Edge, Staffordshire. Since the rock houses were cleared of their last occupants, as late as the 1950's, the rock structures had deteriorated and several of the caves within the three-level complex of up to a dozen separate dwellings had become dangerous. In 1990, the Trust took a bold decision to re-build the upper rock houses and to bring the interior up to modern standards for a Custodian to control the area immediately around Holy Austin Rock.

The Lower Caves were still a serious structural concern. They had been crudely bricked up by the local Council in the 1950's for public safety, as there had been extensive rock falls from the ceiling of the large central cave – an amazing tunnel known in latter years as the Ballroom.

With the financial support of the local Management Committee, the National Trust once again commissioned the Architect for work to secure the Lower Caves, and also to restore the facades and one or two of the rooms to their original design.

The unstable condition of the soft red permian sandstone required careful and often dangerous work inside the caves by the Contractor, G T Wall and Sons of Stourbridge, to secure the falling ceiling slabs.

CASE HISTORY

HOLY AUSTIN ROCK – KINVER, STAFFS, ENGLAND, UK

A major structural defect, resulting from the internal failures, was the large vertical fissure and associated cracks, just behind the eastern facade, which had widened in recent years due to weathering and root penetration. The Structural Engineers, Ascough and Associates, saw the danger of the whole facade falling outwards, as a 1m thick slab, and it was decided to use modern rock bolting techniques to anchor this slab back to the stabilised rock including the new foam concrete fill, just above cave ceiling level. The drilling and grouting of the rock anchors was carried out by A.P.B. Group Limited of Stoke-on-Trent in August 1997. The Specification was for 5 Cintec rock anchors 3 – 4m long, and 20mm diameter, 316 grade stainless steel rebars. The anchors were grouted into 40mm – 50mm diameter holes drilled with air flush rotary rock drills. In addition to the main rock bolts, several more ceiling bolts were installed under the Engineer's direction using 16mm diameter anchors of varying lengths.

The Lower Caves were completed in November 1997 and the National Trust have now raised the status of the caves giving them a detailed entry in the National Trust Handbook.

*Text – John Greaves Smith Dip.Arch. R.I.B.A
Architect*



Adjacent caves in unrestored condition.



Roof bolt support to ballroom ceiling.



The completed row of cave dwellings ready for occupancy.



CASE HISTORY

CYMER ABBEY - DOLLGELLAU, WALES



NAVE ARCADE STABILISATION WORKS

In the field of civil engineering, the method of structural stabilisation used at Cymer Abbey is unique. The Abbey was built in the 12th century, and from the onset suffered during this time of turbulence between the Welsh and invading Norman forces, there followed several centuries of stability until the dissolution of the monasteries around 1537. It was subsequently left to ruin up until present times.

Under the direction of CADW, structural engineers Mann Williams undertook inspection and monitoring of the abbey. This revealed progressive movement of the north arcade masonry which had become unstable to the point where propping was necessary to prevent collapse. For the long term it was decided to use Cintec structural reinforcements because in the words in Mann Williams *"The technique has been recently used successfully on a scheduled ancient monument, and has the advantage of retaining the largest proportion of the original structure in-situ. On completion of the works there is minimal evidence of the work having been implemented"*.

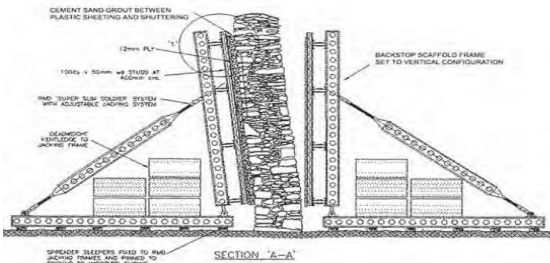

Temporary support frames were positioned either side of the arcade wall (left). With plastic in place to protect the wall, a soft grout was injected between the jacking frame and the masonry and left to set. Pressure was then slowly applied and the wall rotated into the vertical position. Open joints required the careful hand sawing of the original ashlar followed by repointing. 4No. 20mm diameter stainless steel Cintec stud anchors were installed vertically into 76mm diameter holes centrally through the arcade columns and through the wall. A similar horizontal anchor 14m long was then installed horizontally along the arcades length. Finally, numerous small consolidation anchors and arch radial anchors completed the Cintec stabilisation. (See below)



Image revealing the extent of wall and column rotation prior to stabilisation

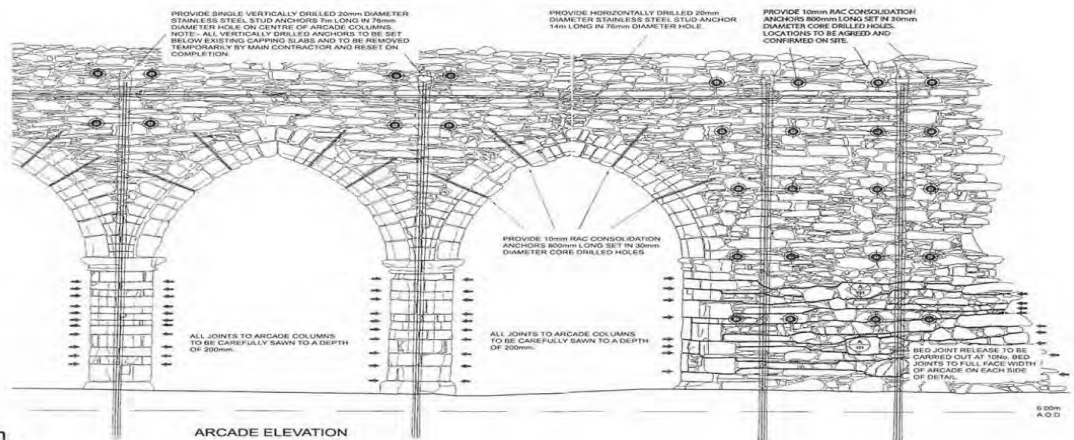

CASE HISTORY

The Roman Ruins of Bet She'an-Scythopolis – Isreal (2002)



CASE HISTORY



Located below the Old City of modern-day Jerusalem, Wilson's arch extended high above the street in the time of Jesus. It is buttressed up against the Walling Wall of the temple Mount and supported a bridge across the Tyropean Valley from the Upper City on the Western Hill. Named after the explorer who discovered it in the nineteenth century, Wilson's extended 75 feet above the valley floor below, and covered a span of 45 feet. In these photographs, the floor on which the people are praying is on the debris from the Roman destruction of the city in 70 AD and later construction. The arch is now only 20 feet above the pavement. Its majestic size and the enormous stones testify to the grandeur of King Herod's aspirations. Today the area beneath the arch functions as a prayer area for religious Jews. Following its excavation in the 1860's, the structure has suffered cracking from regular seismic activity, most recently in the early 1990's and also from more recent nearby excavations of King Solomon's Stables. The strengthening was carried out by Cintec's representation for Israel – Oganim Anchoring Solutions Ltd. With the use of diamond core drilling to within just 200mm of the Western Wall No. 8 Cintec M12 Stainless Steel anchors of between 2.36m and 2.75m long were installed under the supervision of the Authority of Antiquity of Israel. The retaining sleeves of each Cintec anchor preventing the escape of grout into the surrounding voids. The arch pier now stabilized against future seismic activity.



PRESERVING RELIGIOUS STRUCTURES

ALSO REFER TO THE SEISMIC SECTION

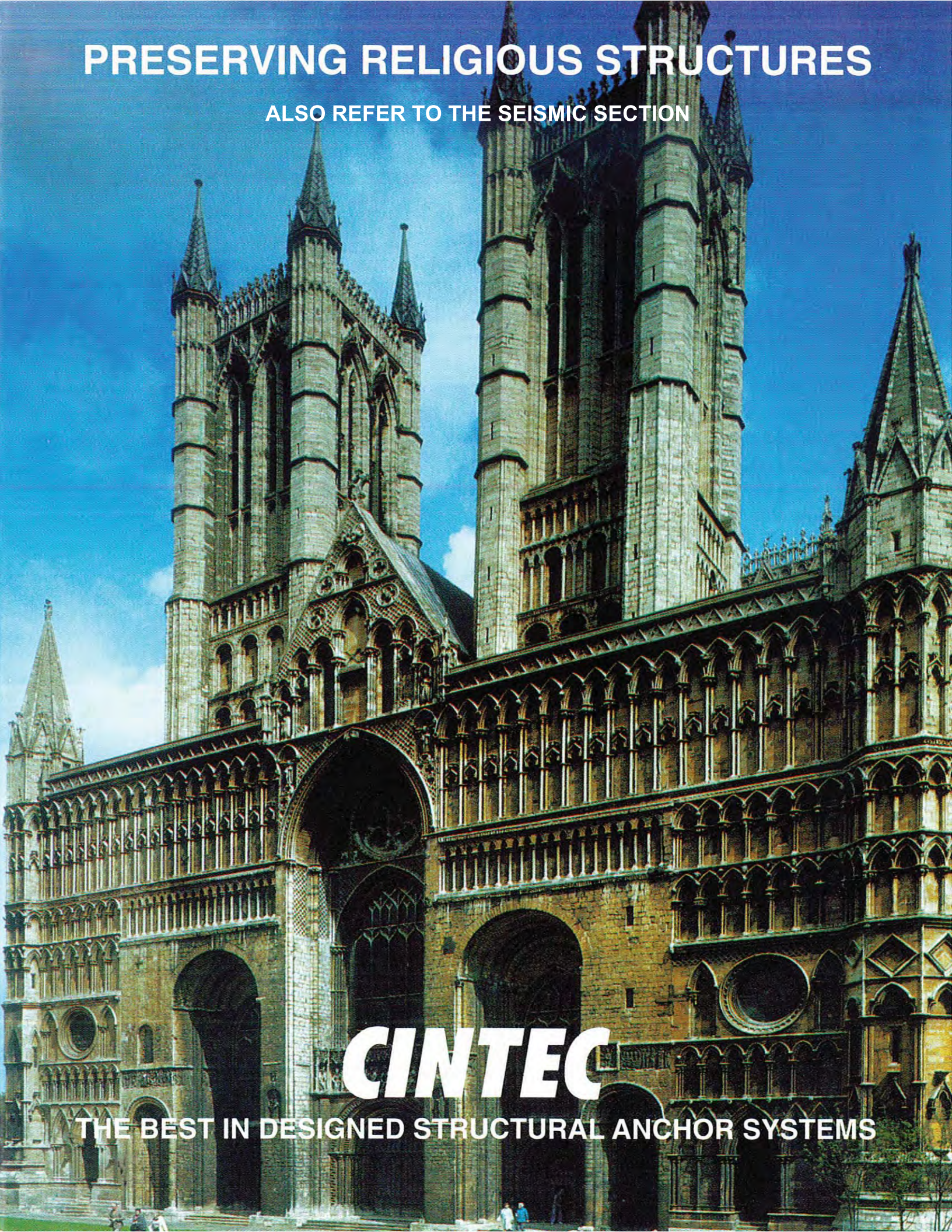

CINTEC

THE BEST IN DESIGNED STRUCTURAL ANCHOR SYSTEMS

CASE HISTORIES

Churches in Australia and New Zealand

Cintec Australasia has been responsible for the repair and strengthening of a number of significant church buildings in Australia and New Zealand. Starting with the earthquake restoration of Christ Church Cathedral, Newcastle which used some 4000 m of Cintec anchors (see separate **Cintec** publications), **Cintec** has gone on to provide sympathetic and cost-effective masonry strengthening solutions when alternatives involved demolition and rebuilding.



◀ Methodist Church, Maitland, NSW (1858). This building suffered damage in the 1989 Newcastle earthquake. 6 m Cintec anchors were used in the wall buttresses to provide the additional strength required to resist future seismic damage.

St Patrick's Cathedral, Auckland New Zealand (1885/1907). Cintec anchors up to 3 m long have been used to repair cracking from foundation movement. ▶



◀ St Philip's Church, Sydney, NSW (1856). Roof spread had led to wall cracking at eave level. Cintec anchors provided the economical repair solution with a guaranteed long life with no visible affect on the building.

St Thomas' Church, Port Macquarie, NSW (1826). This church, built by convict labour from hand-made bricks has suffered foundation movement leading to instability at the corners. Following foundation stabilization, Cintec anchors up to 4 m long have been used to restore the strength of the corners of the building. ▶



◀ St Paul's Church, Spring Hill, Brisbane, Queensland (1889). In order to protect the deteriorating stone spire of this church with a copper-clad cover, the tower had to be strengthened. 6 m long Cintec anchors in each corner of the tower provided the necessary extra strength. The tops of the anchors were threaded to fasten the frame of the cover.



CASE HISTORY

EGLISE ST. PIERRE-APOTRE, MONTREAL, QC, CANADA

The church construction began in 1851 and is claimed to be a "French Canadian jewel" as designed by, the carpenter turned great architect, Victor Bourgeau (1809-1888).

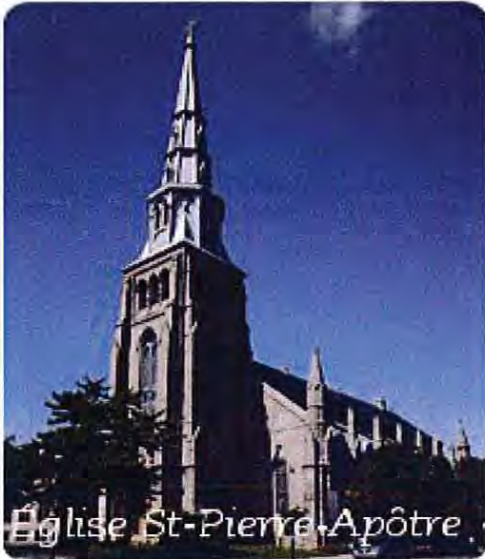

His inspiration for this neo-Gothic church is drawn from the Holy Trinity Church in Brooklyn, New York, USA. He designed everything in the church: the overall plan, the main altar, the lateral altars, the balusters, the tower and the spire (which rises to a height of 72 meters). For the first time, stone is used everywhere, even in the pillars. Exterior construction of the church took over two years, and was to become his masterpiece and its main elements are copied elsewhere in Quebec. The St. Pierre-Apôtre church was classified in 1977 as an "historic site" by the Quebec Cultural Properties Commission. The church hosts the Chapel of Hope, the only chapel in the world dedicated to the victims of AIDS.

The firm, L'Etude de Louis Brillant (Louis Brillant, President) is a well known heritage architectural firm in the greater Montreal area. Louis had worked with the Cintec Anchoring System, on many former projects, so was comfortable using it on this one.

Although many anchors were used, the only anchoring challenge was at the left corner of the West Elevation (plan right). An adjacent structure limited access to less than 5 feet. Cintec had been on many projects where lateral or overhead access restrictions were present (bridges) so a solution was at hand. This required manufacture of segmented anchors with the ¾ inch diameter, 304 stainless steel limited to 4 foot long pieces. The patented sock, 2 ½ inch diameter by 20 feet long (full required length) was shop installed on the first section and it along with 4 other steel pieces and required couplers were shipped to site unassembled.

The masonry contractor, Masonry Excel (Richard Dagenais, President), had no prior experience with the Cintec Anchoring System, yet his capable people had no problems with the assembly and installation after suitable training and supervision. When the anchors arrived on site, they simply inserted the first section into the pre-cored hole followed by the insertion and coupling of subsequent sections until the desired 20 foot length was achieved. All that remained was to inject the Presstec grout and installation was complete.

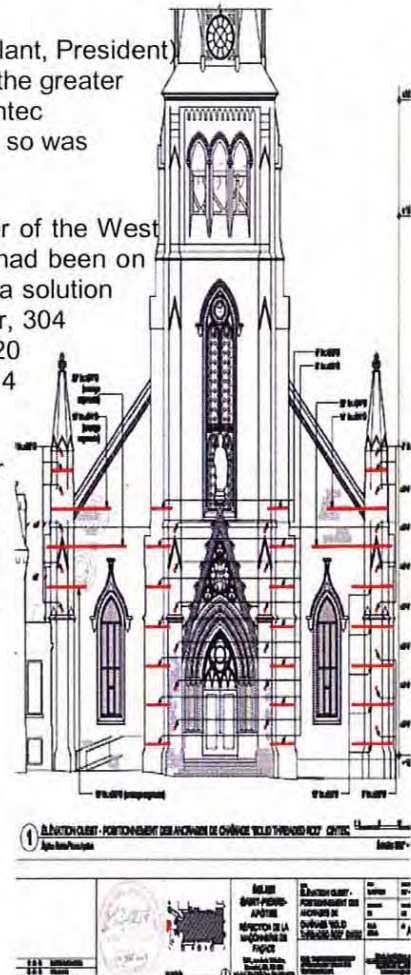

ARCHITECT
L'ETUDE DE LOUIS BRILLANT
460 Sainte-Catherine ouest, suite 408
Montréal, Québec
H3B 1A7
(514) 396-5111

CONTRACTOR
MAÇONNERIE EXCEL INC.
1130 Rue Du Geai Bleu
St. Jerome, Quebec
J5L 2R5
(450) 432-8649

CASE HISTORY

FIRST LUTHERAN CHURCH OF THE REFORMATION: NEW BRITAIN, CT

The First Lutheran Church of the Reformation building which currently houses the congregation, was built from 1903-1906. Its architect was W.H. Cadwell and the contract for construction was given to Murphy Brothers of Norwich. The exterior is “native marble” from Ashley Falls, MA. The interior was renovated in 1923. Two spires which originally graced the north and south towers were removed after lightning struck the south tower in 1925.

The Senior Pastor Rev. Elisabeth A. Aurand stated that the congregation decided at the end of 2008 to remain in its 1906 building at 77 Franklin Square and to solve the problems of the physical plant, particularly two structurally faulty towers. It adopted the *Cintec System* for tower stabilization, an installation of stainless steel anchors made by *Cintec America*, which will allow completion of the work at half the cost of traditional masonry methods. In addition, the church has gained a listing on the Connecticut State Register of Historic Places and has submitted an application for placement on the National Register



CASE HISTORY

Contractor Joseph Gnazzo in conjunction with Engineer Joseph Picarro of AJP Engineering, LLC implemented the tower stabilization process shown below.

Type A was the approach used to stabilize the deteriorated areas of the faces between the corners with a M12 1/2" dia S/S Anchor set into 1 1/2" diameter hole.

Type B was the approach used to stabilize the displacement of the external pilasters of the tower with Cintec M16 5/8" dia S/S Anchors set into a 1/4" diameter hole.

Type C was the approach used to cross stitch the pilasters with Cintec M12 1/2" dia S/S Anchor and set into a 1 1/4" diameter hole.

Type D was the approach used to support the beams on galvanized wall brackets attached with Cintec M20 3/4" dia S/S bracket anchors and set into a 2" diameter hole.

Type E Involved installing on row of Cintec M16 5/8" dia S/S anchor and set into a 1 1/2" diameter hole.

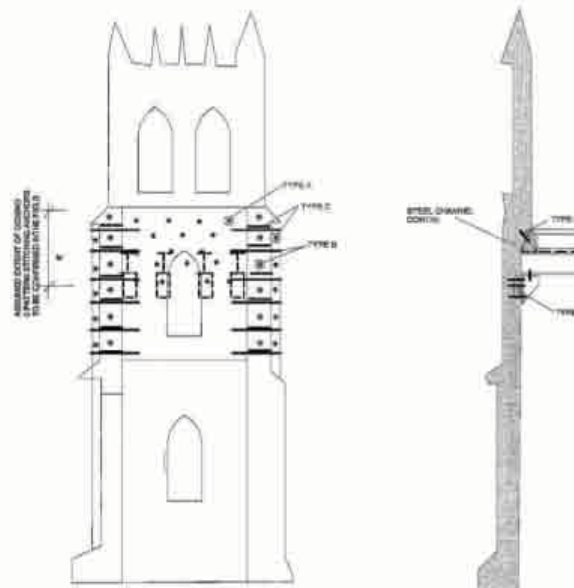

General Contractor

Joseph Gnazzo Company

Bruce Panico
1053 Buckley Highway
Connecticut, Union
06076
860-684-2334

Engineer Of Record

AJP Engineering LLC
Joseph Porarco
Connecticut, Berlin
22 Robbins Rd
06037
860-539-5318

CASE HISTORY

Masonry Wall Conservation

SAINTE-ANNE D'OTTAWA CHURCH, BUILT IN 1873

by John G. Cooke, Engineer

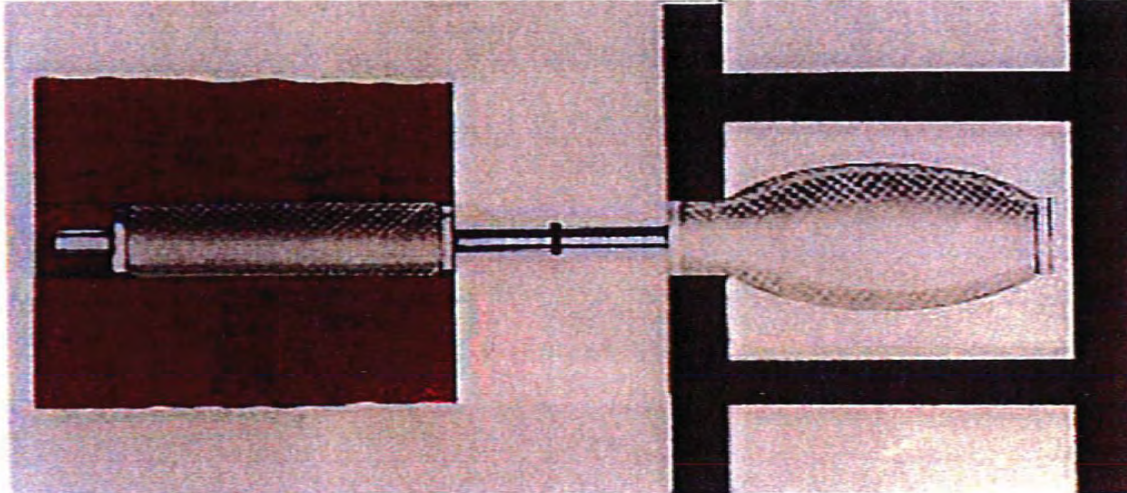

THE CHURCH OF SAINTE-ANNE d'Ottawa was built in 1873 on Old St. Patrick Street. In the fall of 1893, the church was extended by the addition of the transept wings and the reconstruction of the sanctuary. The new church was inaugurated on February 25, 1894. In 1967, major renovations to the church were carried out. These repairs included repairs to the main roof trusses, the replacement of the timber floor in the church with a reinforced concrete slab and the addition of a basement below the sanctuary, including a mechanical room. The building was designated a heritage property in 1978 by the City of Ottawa, in accordance with provincial heritage legislation.

EXISTING CONDITION

In the fall of 1990, Anrep Associates Ltd. were employed by the parish of Sainte-Anne d'Ottawa to investigate the cause of a serious bulge on the exterior face of the west transept wall. Upon investigation of the wall it was discovered that, on the inside face of the wall at the location of the bulge, there was a recess in the wall measuring 6' X 7' x 14' dp. approximately. Additional investigation revealed the same recess at the opposite end of the west transept wall and two similar recesses on the east transept wall. In one of the recesses in the east transept wall, part of the timber lintel over the opening had deteriorated due to moisture and failed. This resulted in a large amount of the rubble, between the interior and exterior stone wythes, falling into the recess.

The walls themselves consisted of two wythes of stone, with rubble and mortar in the centre. The walls were about 26" thick. Over time, the mortar in the centre had been

CASE HISTORY

reduced to sand. With constant weathering, freeze thaw cycles due to moisture penetration into the walls, and vibrations, the loose rubble worked its way down the wall, slowly acting like a wedge to pry the two stone wythes apart. This action eventually leads to the wall no longer acting as a single unit, but has two separate wythes acting independently. This results in a substantial weakening of the wall and eventual failure. It was our conclusion that this, in combination with the weakening effect of the recess, was the cause of the bulge. We recommended that the client shore the wall immediately until remedial work would be carried out. In addition, we were also concerned that the potential was high for the same condition to occur on the east wall.

SOLUTION

In consultation with the client, it was agreed that we would not try to remove the bulge in the west transept wall as the cost to shore and stabilize the wall above, while rebuilding the lower section of wall, would be excessive. In addition, in order to strengthen the transepts it was agreed that the interior recesses be built up in order to increase the wall capacities at the location of the recesses. These recesses were covered by the drywall finish on the interior face of the walls, so were not exposed. Structurally, our concern was that due to window placement in the wall, most of the wall self weight was transmitted to the foundations by way of the wall at the location of each recess.

We proposed to repair the walls as follows in order to restore their structural and historical integrity.

1. Rebuild the four recesses (two in each transept wall) using a similar limestone, with a lime base mortar.
2. Anchor the two wythes of stone together using a CINTEC anchoring system.
3. Pressure grout the voids in the wall using a cementitious grout.
4. Rake out the existing joint mortar to a depth of approximately 55mm and repoint the wall using a Lime, White Non-Staining Portland Cement, sand mortar mix. At the client's request, the joints were retooled to match the profile of the mortar joints on the remainder of the structure.
5. At the corner where the bulge existed, the exterior wythe of masonry was stitched using CINTEC stitching anchors. The anchors were installed in holes drilled parallel to the exterior wall face in two directions, staggered, and spaced at 300mm on centre. These anchors were 3000mm long in one direction and 1200mm long in the other direction.
6. Below grade, where the mortar in the joints had deteriorated to sand, the joints were regouted as above grade, the face of the stone was parged, and a protective coating of a waterproof material was applied to the face of the parging.

ANCHORING SYSTEM

The CINTEC anchors, noted above, originated in England and provided a much better anchoring system than expansion anchors, for the conditions in question. The anchors consisted of a hollow structural steel section which is surrounded by a fabric sock. Grout is pumped into the tube and extrudes through a hole at the inner end of the steel section and fills the fabric sock from the inside out. When the moisture in the grout mix seeps through the fabric on the exterior hole face, the installer knows that the fabric sock has filled the void, and the desired pressure has been achieved. This

CASE HISTORY

moisture also seeps into the surrounding parent material and forms a cementitious bond.

The CINTEC anchors were chosen on this project because of their adaptability to be designed for the specific project and the compatibility of the anchoring system with the parent wall material. The stress between the interface of the anchor and the parent material is low due to the large area of the interface. This makes the anchor ideal for use in old/heritage type buildings, where the strength of the parent material is generally low. The lower the strength of the parent material, the larger the diameter of the hole drilled in the wall and the larger the diameter of the fabric sock.

The typical wall anchors noted in item #2 above were 55mm long. They were spaced at 900mm on centre horizontally and 450mm on center vertically. The outer end of the anchors were recessed 25mm from the face of the wall and covered with the lime based mortar.

SUMMARY

Anrep Associates Ltd. worked closely with the client, with representatives of the Heritage department of the City of Ottawa, with the general contractor, Lariviere Construction Ltee. from Hull, Quebec, and with CINTEC representatives from England, to successfully stabilize and restore the condition of the transept walls, while matching the wall finish with the remaining walls of the church. Though the mortar joint was brighter than that of the mortar on the other walls, it was felt that the brightness would fade over time due to weathering of the mortar joint. The restoration permits the transept walls to perform in the manner they were intended and thus prolong the life of the structure.

Engineer

Anrep & Associates

**John G Cook & Associates
1750 Courtwood Crescent, Suite 101
Ottawa, On K2C 2B5
(613)226-8718**

Masonry Contractor

Lariviere Construction Ltee

**640 Auguste Mondoux
Gatineau, QC J9J 3K3
(819)770-9703**

CASE HISTORIES

ST JOHN THE BAPTIST CHURCH - BRISTOL



Parapet and Buttress Strengthening

The present building of St John The Baptist Church in Bristol dates from 1350 - 1500 and possess two features of architectural note. Firstly it is a two-storey structure having a crypt extending above ground almost the whole length of the nave and chancel. Secondly it incorporates, below its tower, the only remaining City Gate of Bristol, the church itself located entirely within the old city wall. In 2005 Cintec anchors were installed to secure the two roof level embattled parapet walls and also to strengthen the spire buttresses and secure their pinnacles.

The capping stones of the limestone parapets were removed and vertically core drilled by the installers Protectahome Ltd with 40mm diameter holes and 2150mm in length. The 16mm diameter stainless steel anchors were twin socked (Fig 1) in order they be post tensioned - a process of firstly inflating the lower sock while applying tension to the anchor with a metal plate screwed onto the exposed thread on the upper end on the anchor. One set the second sock is inflated and the tensioning plate removed. The capping stones were then replaced to conceal the anchors within (fig 2). In all No.64 parapet anchors were installed and another No.8 deformed bar anchors were used to strengthen the medieval spire buttress as well as their ornate pinnacles (Fig 3).



Twin socked anchors designed to tension the upper parapet sections into the base of the parapet.

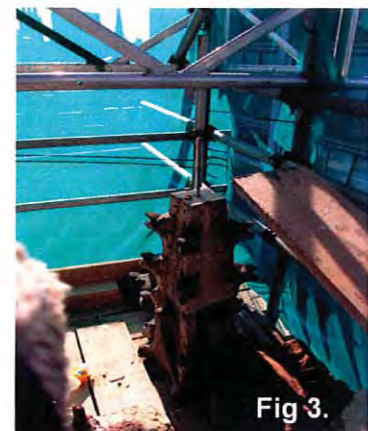
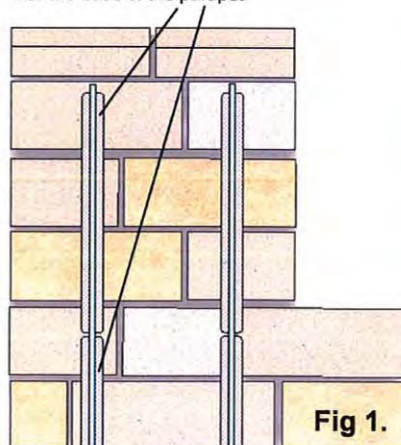

St. Alphonsus Church

Baltimore, MD

Project Engineer: Keast and Hood Company,
Washington, DC

General Contractor: Structural Preservation Systems,
Elkridge MD

Owner: Baltimore Archdiocese

Date: 2007



St. Alphonsus Church was built in the 1840s in downtown Baltimore, Maryland. Dubbed the German cathedral because it served the local German community, this striking example of neo-Gothic architecture is constructed of brick with a slate roof and sandstone column capitals. In 1917, the Roman Catholic Church bought the church and it was designated an Archdiocesan Shrine in 1994.

The original design by architect Robert Cary Long Jr. called for spires on all the columns. When rehabilitative work was required on the capstones, the Archdiocese decided to also add the spires to match the architect's original vision.

Why Cintec anchors?

The inspection found that the deterioration of the sandstone capstones was caused by years of weathering and freeze-thaw cycles, as well as maintenance neglect. Cintec anchors were specified not only because they could stabilize the capstones, but also because they could handle the wind load requirements for the spires, they were compatible with the masonry, and they could anchor the base plate for the spires.

Cintec made 20 four-foot (1219 mm) stainless steel anchors designed to a 50 psf (2.39 kPa) wind load, wind shear of 600 lbs. (272 kg) per anchor and an uplift of 400 lbs. (181 kg) per anchor.

The anchors are expected to provide a rust-free holding capability for at least 100 years, satisfying the client's desire for a long-term solution.

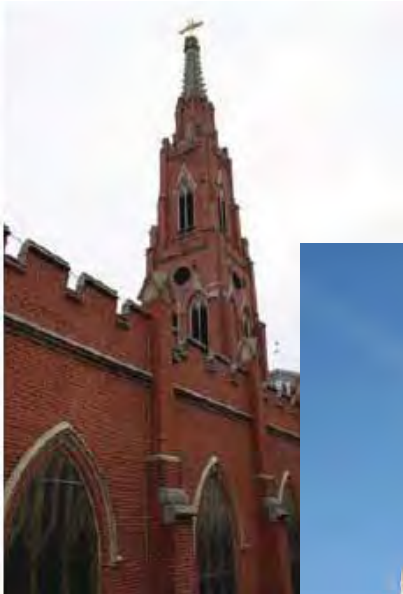

The work

First the general contractor repaired and stabilized the capstones for the spire installation. Working on site from aerial lifts, the general contractor drilled a 1.5-inch (38 mm) hole in the centre of each column for inserting the anchor wrapped in the patented Cintec sock. The sock was injected with Cintec's non-shrink cementitious grout to hold the anchor in place. Six inches (150 mm) of thread was left exposed above the base of the column for attaching the stainless steel base plate. The base plate then held the spire in place.

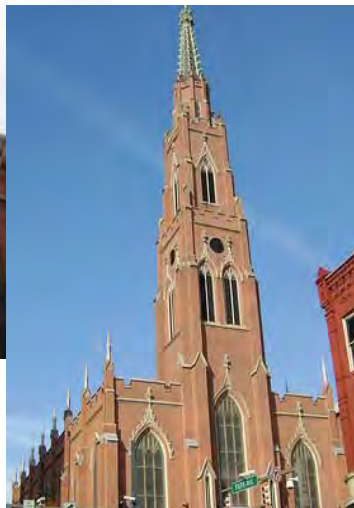

The architect's vision

This historic structure now realizes the architect's original vision and is solidly anchored for safety and posterity.

Photo courtesy of Chauncy Primm.

CASE HISTORY



Taiwanese Temple

Constructed in an area of seismic activity, previous earthquakes have taken their toll upon this brick built Taiwanese temple. Some form of remedial work was clearly necessary. With their extensive experience in this field, Cintec has provided the ideal solution; by August 2003, Cintec will supply 720 metres of M16 studding anchor installed in lengths of between 5 and 15 metres. These anchors, located both vertically and horizontally, will both repair the damage previously incurred, and furthermore act as a semi-flexible steel skeleton within the masonry fabric enabling the structure to better survive future seismic events.

The temple is of high architectural and historical importance. The Cintec solution not only fulfills the engineering requirements, but because it is 'invisible' when installed, there will be no visible change the temple's original appearance.



Hard Brick Construction

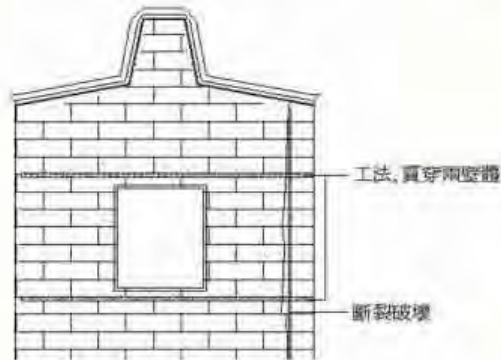

工法



碳纖維版工法

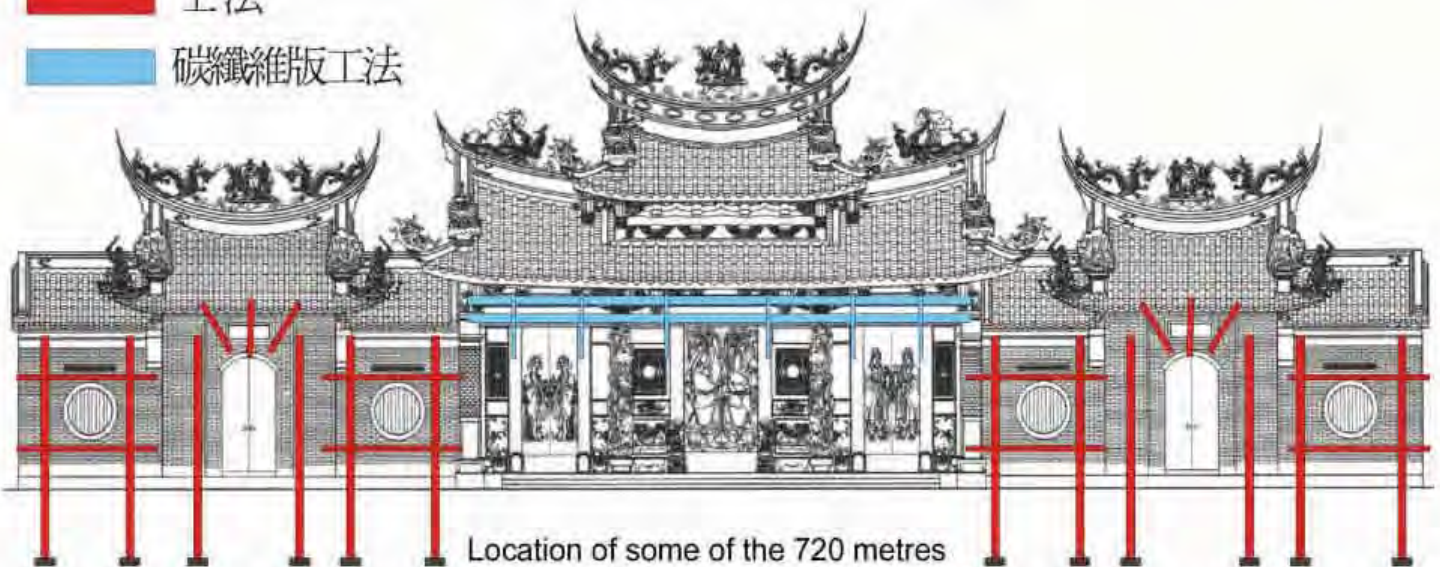

Location of some of the 720 metres of M16 studding anchors to be installed

SEISMIC REINFORCEMENT SYSTEMS FROM CINTEC



Oldbury Power Station



Located on the Severn Estuary in Gloucestershire, England, Oldbury Nuclear Power Station has supplied power to the National Grid since 1967. In the autumn of 2003 work began to strengthen the Hot Gas Release facility in order to withstand the potential damage that may result in the unlikely event of an earthquake.

The concrete walls surrounding the facility were reinforced by the addition of several hundred steel I beam stanchions. Cintec anchors were used to provide the secure connection between these vertical supporting posts and the concrete wall itself. Approximately 8000 cintec anchors were installed in all comprising mainly 12mm diameter high yield steel rebar, M10, M12 and M20 studded anchors in 8.8 carbon steel, in lengths of 290mm (7 1/2") to 400mm (16").

The following year further seismic support was added to the brick walls within the facility in the next and final phase of the upgrade.

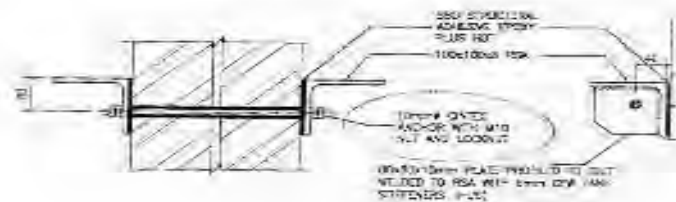
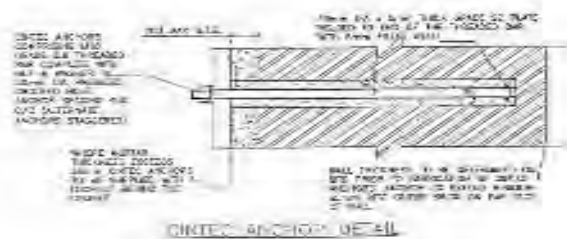
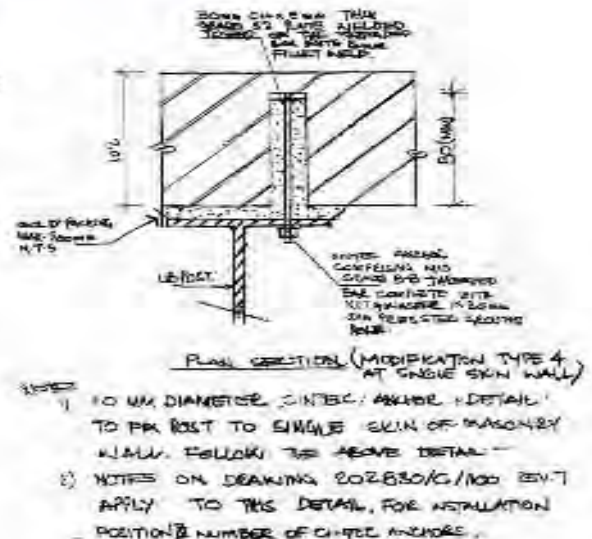

Wylfa Power Station, Anglesey, North Wales UK



A brick concrete structure near to the central core of Wylfa Power Station was deemed to be at potential risk of collapse in the unlikely event of strong seismic activity. The walls consist of an inner and outer leaf of brick and concrete and the connections tying the two together were considered unsatisfactory. Heavy duty high tensile ferrous 12mm diameter wall ties were installed to secure the structure in the event of an earthquake. A number of Cintec Stud Anchors were also installed to provide anchorage for electrical equipment (fuse boxes, cable ducts, pipes etc) which were subsequently attached to the inner leaf.

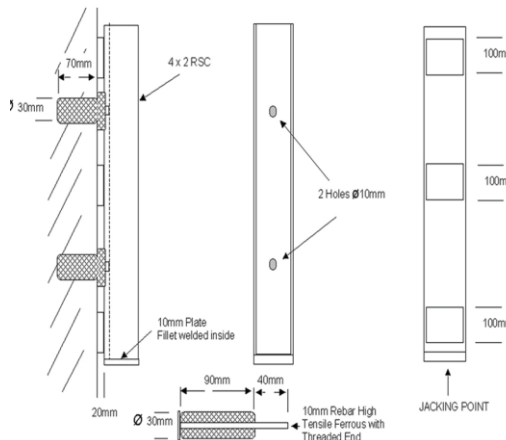

Cintec Anchorage for electrical equipment

CASE HISTORY

Eglise Aizenay, France



CASE HISTORY



In order to repair damage caused by centuries of seismic activity, This French project involved the installation of 11 meter vertical anchors through the flying buttresses together with 260 RAC consolidating anchors comprised of 40 No. 1500mm 10mm CHS RAC's plus 110No. 1300mm and 110No. 700mm of the same type

CASE HISTORY

NORTH OR RED PYRAMID AT DAHSHAR, CAIRO, EGYPT



When Sneferu, king of Manetho's 4th dynasty, came to the throne in 2575BC, Djoser's pyramid at Saqqara was the only large royal pyramid that stood complete. Sneferu would become the greatest pyramid builder in Egyptian history by constructing the three colossal pyramids (at Meidum and the Bent and the North, or Red pyramids, at Dahshur). Together with his son and grandson, who built the two great pyramids at Giza, he was responsible for the constructing the largest volume of stone pyramids in the world. After thirty years of his reign Sneferu abandoned the Bent pyramid as his burial place, instead he began work on the North or Red pyramid which was built to a much gentler slope of $43^{\circ} 22'$.



Front elevation of cracked beam

CASE HISTORY

NORTH OR RED PYRAMID AT DAHSHAR, CAIRO, EGYPT - THE PROBLEM

The present problem was not on the exterior of the pyramid but one on the corridor between the corbelled burial chambers. The beams spanning the low corridor opening were cracked, from the base of the stone beams, up through the centre of the beams, to a position just adjacent to the centre at the top of these stone beams. It was impossible to drill at right angles to the corridor due to the mass of the core of the pyramid. However, it was possible to drill at an angle of 43 degrees in the respective burial chambers at both the entrance and exit of the corridor and secure the beam with a row of 20mm diameter Cintec stainless steel consolidation anchors. Work was completed at night after the monument was closed to the public because the position of



The high burial chamber

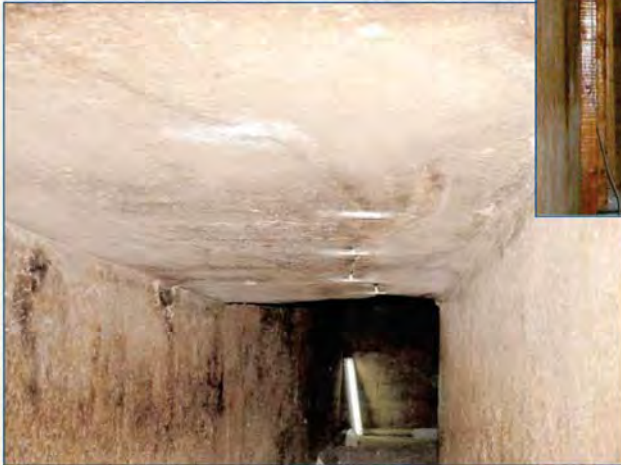

Soffit of cracked beam in the corridor between the burial chambers

the burial chamber was some 60 metres down a 45 degree slope and a dust extraction unit and breathing apparatus was required by the operatives.

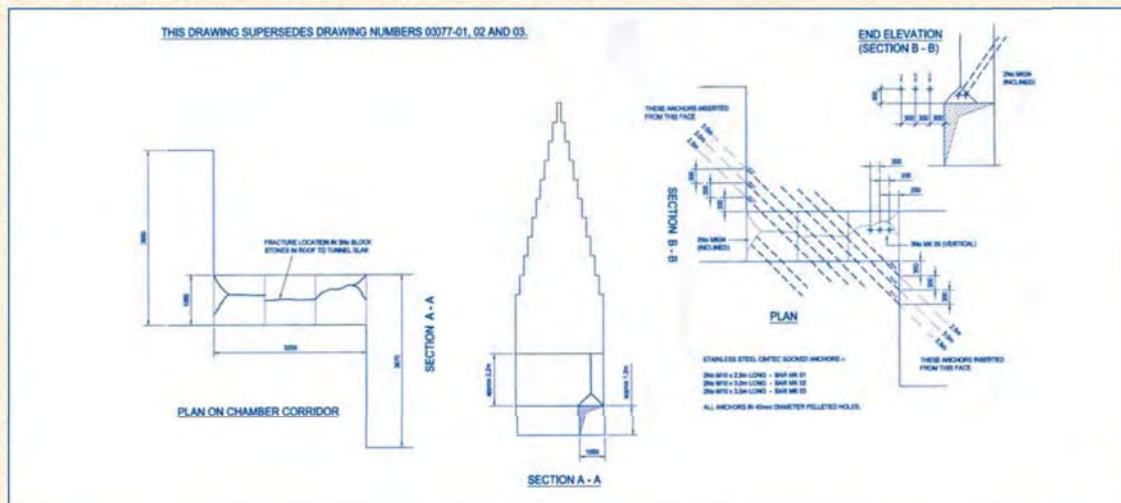

CASE HISTORY

CURRENT PROJECT: PHASE I

Egypt's oldest pyramid at risk and a British company has been called in to stop its collapse

By [Daily Mail Reporter](#) Last updated at 3:39 PM on 5th January 2011

A British engineering firm have won a lucrative contract to help save the oldest pyramid in Egypt.

The 4,600-year-old pyramid of Djoser almost collapsed in 1992 after being hit by an earthquake.

But in a bid to preserve the ancient structure, a firm from South Wales has been called in to keep the pyramid standing.

To find out more on this project and many others by visiting our FaceBook page or by following the links below:



<http://www.dailymail.co.uk/news/article-1344204/British-firm-called-save-Egypt's-oldest-pyramid.html#ixzz1Ae94ApUd>

<http://www.theworld.org/2011/01/07/restoring-a-pyramid/>

<http://www.bbc.co.uk/news/uk-wales-south-east-wales-12131830>

<http://www.pasthorizons.com/index.php/archives/01/2011/21st-century-welsh-technology-to-save-egyptian-pyramid>

<http://www.talkingpyramids.com/>

<http://ca.search.yahoo.com/search?ei=utf-8&fr=slv8-tyc8&p=djoser%20%2b%20Cintec&type=>

<http://allaboutegypt.org/2011/01/saving-the-step-pyramid-of-djoser/>

<http://www.ukti.gov.uk/export/unit>



edkingdom/wales/item/123314.html

Rescue operation: A Welsh engineering firm has been called in to save the Pyramid of Djoser in Egypt. A team from Cintec in Newport has been contracted by the High Council of Egyptian Antiques to rescue

CASE HISTORY

Rescue operation: A Welsh engineering firm has been called in to save the Pyramid of Djoser in Egypt. A team from Cintec in Newport has been contracted by the High Council of Egyptian Antiques to rescue the landmark, which is also known as the Step Pyramid. The firm worked on Windsor Castle after the fire of 1992 and was also called upon by the Indian government to strengthen a major Delhi bridge ahead of last year's Commonwealth Games.

Landmark: The 200ft pyramid was built in around 2650BC



And after building a reputation for preserving landmark structures, Cintec has won an £1.8million contract to save the Pyramid of Djoser.

The engineers will use self-inflating water-filled bags to bolster against the collapse of a damaged ceiling inside the pyramid. Stainless steel structural reinforcement anchors will also be implemented in a bid to secure the strength of the building's central chamber.

Peter James, managing director of Cintec, said: 'We are extremely pleased to have been appointed for this project and are always looking for new methods to support and maintain

historical landmarks across the globe. We recognize the importance of both historical and religious structures to their cultures and hope to continue to develop advanced reinforcement systems that will preserve archeological structures for future generations.

'The Step Pyramid project is of particular importance to us as the entire structure could be destroyed at any point due to the damage on the ceiling and roof caused by the earthquake. 'We aim to work as efficiently as possible on this project without comprising the design or strength of the structure.' Built in around 2650BC as a burial place for Pharaoh Djoser, the Step Pyramid can be found in Saqqara, around 19 miles south of Cairo.

CASF HISTORY

THE MADRASA & KANQAH OF SULTAN AL GHURI, CAIRO, EGYPT

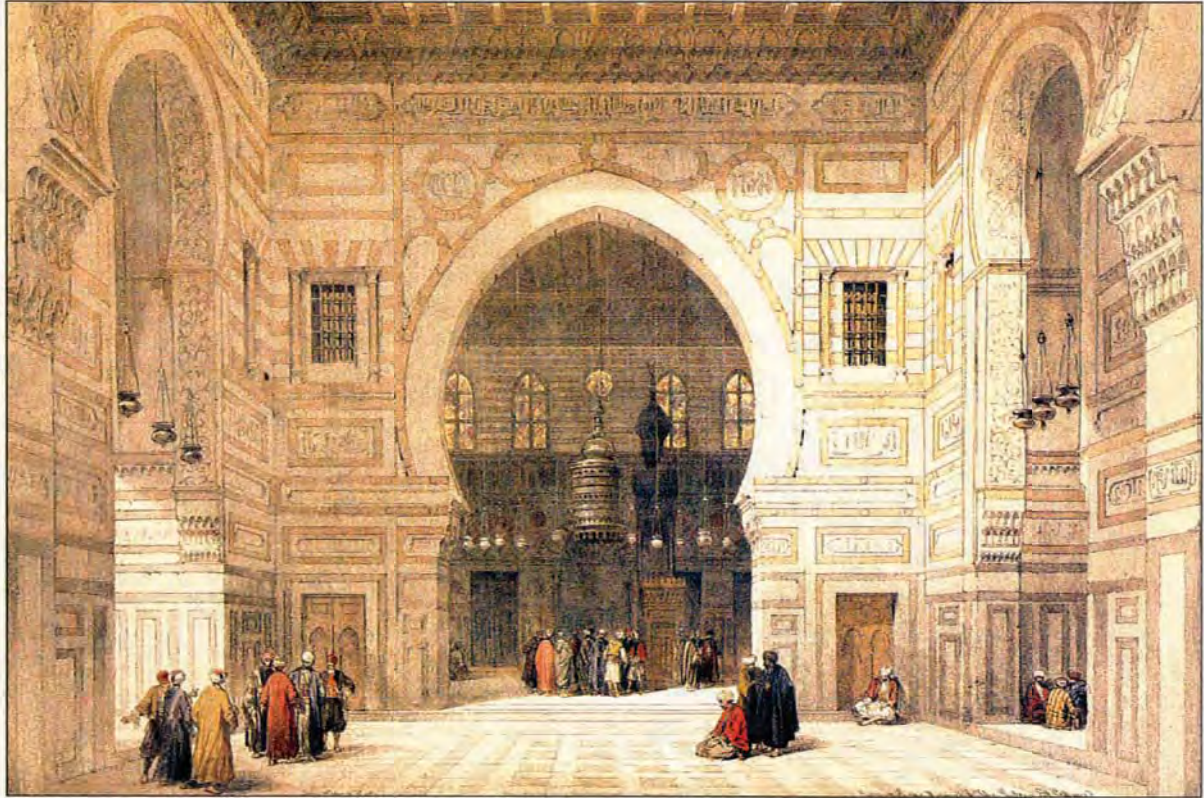

19th century illustration of Mosque

The Madrasa and Kanqah of Sultan al-Ghuri is monument number 189 of the Mohammedan monuments under the care of the Egyptian Antiquities Organisation. It is of the date 909-10 AH 1503-4 AD.

The Sultan Qansul al-Ghuri was the last but one of the Mameluk Sultans enjoying an unusually long reign for this period (1501-16). The Sultan died in the midst of battle against the Ottoman Turks, his body never discovered.

The funerary complex of Sultan al-Ghuri is situated in the Fahhamin quarter of Old Cairo in al-Muizz Street. On the west side there is a kanqah and mausoleum as well as a sabil kuttab. The minaret is a four storied rectangular structure approximately 50 metres high.

The Madrasa Mosque with its strong features, bold design, marble panels and intricate geometric design carved into the surface of the arches and ceiling represents the last great flowering of Mameluk art.



The al-Ghuri Mosque

CASE HISTORY

THE MADRASA & KANQAH OF SULTAN AL GHURI – THE DAMAGE

An inspection of the Madrasa revealed some very severe long-standing problems. The floor of the mosque undulated dramatically, providing evidence of very significant foundation problems of the masonry vaults supporting the floor. Attempts had been made in the past to underpin the sleeper walls supporting the vaults, these had failed. All of the walls of the mosque exhibited very severe fractures. The problems were brought about by earthquake damage in October 1992 and by the rising contaminated ground water. Further problems in the external walls had been caused by the activities of the shopkeepers trying to enlarge the space available for selling their wares. As a consequence, sections of masonry have been demolished at ground floor level to create this additional space.



Seismic damage to decorative arches

The net result of the above was that the mosque of al-Ghuri was in a very delicate state of equilibrium. Despite having survived for nearly 500 years, the toll of a rising water table, earthquakes and neglect had brought this structure to the point of collapse. Urgent measures were required to reintroduce some structural strength and stiffness into the building.



Temporary support of the Dikka arches

It was understood that the Madrasa was underpinned by using a system of micropiling. The requirement therefore remained to tie the elements of the superstructure together. The very high walls were laterally unrestrained and very vulnerable to lateral forces such as may be produced by the next earthquake.



Lintel stones

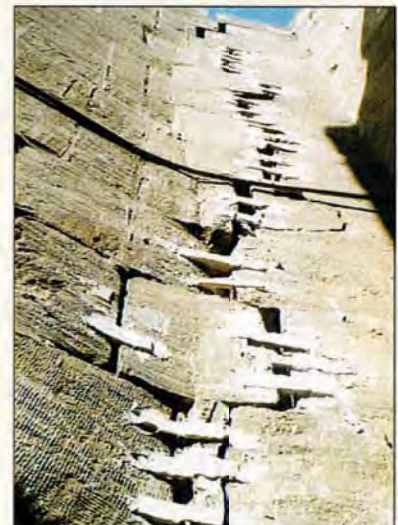

Vertical shear crack

CASE HISTORY

THE MADRASA & KANQAH OF SULTAN AL GHURI, CAIRO, EGYPT – THE REPAIR



Dikka arch in the main courtyard

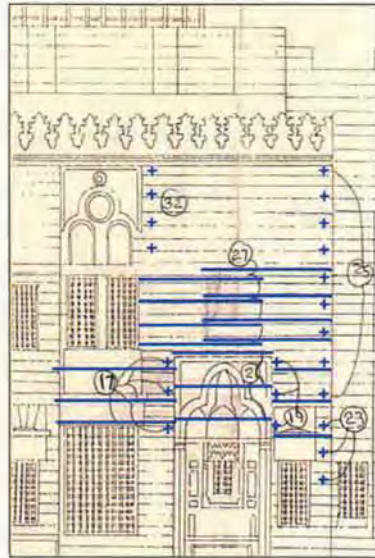

The Cintec stitching system was extensively used at al-Ghuri. These reinforcement anchors, up to 12 metres long, serve to stiffen each individual wall immensely. The walls of al-Ghuri are generally of two facing skins in-filled with a core of rubble. The large arched openings in the mosque are particular points of weakness in the structure. Longitudinal ties in each of the stone facings of the wall above the arch would serve to resist the thrusts naturally produced by the arch as well as serving to assist the walls to resist the next earthquake. In addition to longitudinal ties, transverse ties of length equal to the thickness of the wall were introduced to increase the strength of the wall.



Drilling the vaults

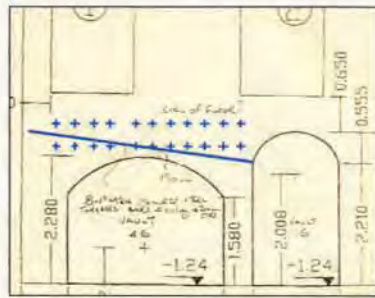

Typical repair detail for the arched vaults at ground level



Front core replaced, after anchor installation and made good



Drilling the stonework after removal of front core



Decorative panels being drilled ready for installation of consolidation anchors



Anchor installed & inflated ready for front core to be replaced



The diamond drilling rig



Diamond drilling the arch stones

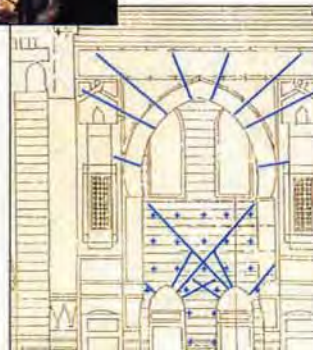

Typical anchor placement details for the arches and side walls

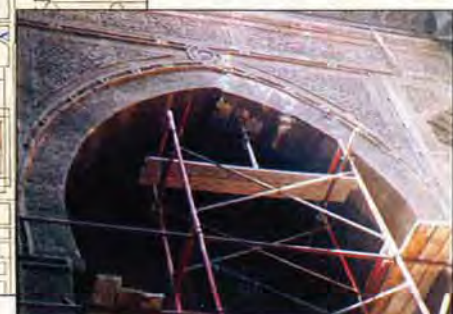

One of the four arches of the court being scaffolded prior to drilling and anchoring

CASE HISTORY

THE MADRASA & KANQAH OF SULTAN AL GHURI, CAIRO, EGYPT

The Cintec stitches would also be used to tie the roof structure to the perimeter walls and create a diaphragm action. Again this is an internationally recognised system of introducing greater stiffness and earthquake resistance into a structure. The beauty of the Cintec anchor is that it contains the grout to be used within a sleeve and control of grout flow and its impact upon the existing structure is therefore very good.

The anchors to be used would be invisible in the repaired structure, eventually over 1200 metres of anchors were installed at al-Ghuri. The installation team needed to keep a fine balance between the archeological project and Egyptian Authority whilst encountering natural hazards like dust, confined working spaces, insects and high temperatures.

The success in refurbishing this ancient mosque, was as a result of the combined association of Cintec, Arab Contractors, Intro Trading and the advice and co-operation of the Egyptian Antiquities Organisations thus ensuring the stability of this 500 year old important heritage building.



typical consolidation anchor prior to grout injection



5 metre long vertical anchors at roof level



Roof section above central courtyard

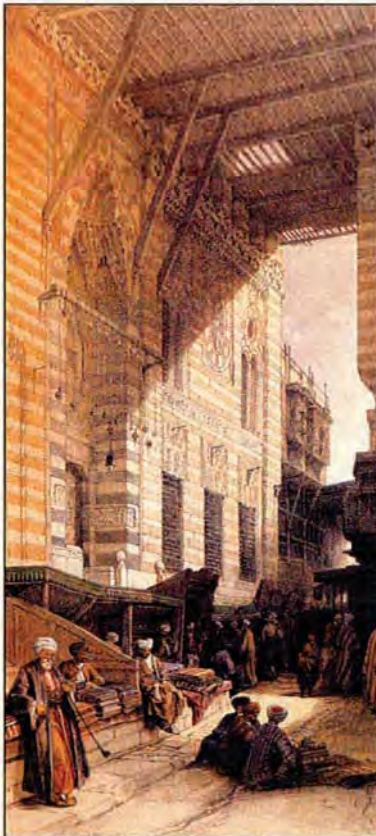

*Market place outside Mosque
19th century illustration*

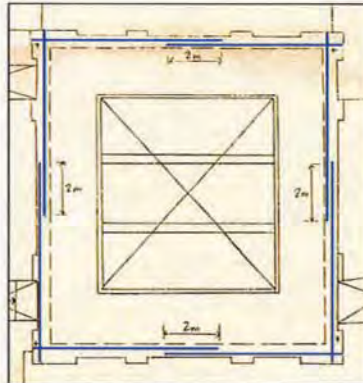

Roof consolidation anchors

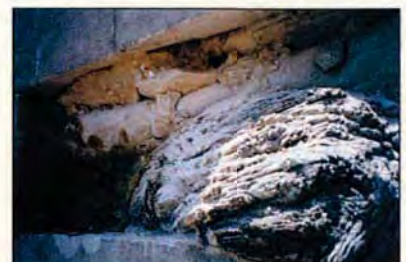

installed roof anchor

CASE HISTORY

CHRISTCHURCH CATHEDRAL NEWCASTLE, NEW SOUTH WALES, AUSTRALIA



Christ Church Cathedral is an extraordinary piece of architecture in a dramatic setting. Australia's largest provincial cathedral, dating back to 1893. Stylistically the building expresses the significant changes from the Victorian period of architecture with its reliance on academic correctness to the freer realisations of the Federation period and its influence by the Arts and Crafts movement in Australian architecture.

At 10.27 am, on Thursday 28th December 1989, the city of Newcastle in New South Wales was struck by the first significant earthquake to affect an Australian urban area. The earthquake, registering 5.6 on the Richter scale and with a Modified Mercalli Index of up to VIII, had an epicentre approximately 14 km south west of the city's centre. The most important building to be severely damaged was Christ Church Cathedral.



Christ Church Cathedral Dominates Newcastle skyline.

CASE HISTORY

CHRISTCHURCH CATHEDRAL – THE DAMAGE



Earthquakes had previously occurred in Australia only in sparsely populated areas, and most practising structural engineers and building authorities knew little, if anything, about earthquake design requirements.

The effect of the earthquake was largely as might be expected: high set stone crosses and other decorations fell to the ground, flying buttresses were dislodged, shear cracking occurred in the north and south walls and out-of-plane movements occurred in the east wall, dislodging windows.

Work on a building such as Christ Church Cathedral is governed by State heritage legislation which invokes the International Council on Monuments & Sites

(ICOMOS) principles derived from the world body's Venice Charter. To repair and strengthen the Cathedral, reinforcement of the walls was necessary, with least visual intrusion or damage to the existing fabric. Materials had to be found which were compatible with the masonry of the building and which ensured the long life for which cathedrals are noted.



CASE HISTORY

CHRISTCHURCH CATHEDRAL NEWCASTLE, NEW SOUTH WALES, AUSTRALIA. RESTORED



The Cathedral has enjoyed a unique position as a focus for the lives of the people of Newcastle, the region and in many respects the State and Nation in terms of tourism and the perception of Newcastle as a city.

Its restoration, in some part due to the unique capabilities of the Cintec anchor, ensures that the edifice has returned to its former glory and is stronger, and ready to face another 100 years.

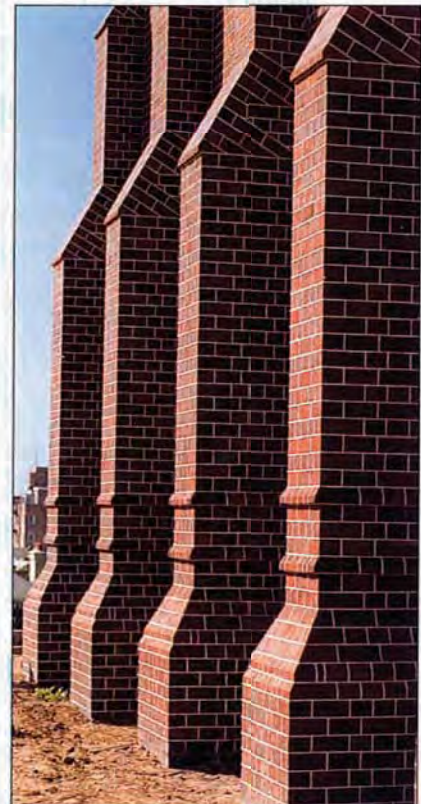

CASE HISTORY

CHRISTCHURCH CATHEDRAL NEWCASTLE, NEW SOUTH WALES, AUSTRALIA – THE REPAIR



The Cintec Anchor System was chosen by the engineers to solve the Cathedral's problems when it became obvious that no other company had the materials, experience and expertise to meet all the requirements. Bill Jordan, a structural engineer who runs the Cintec operation in Australia, convinced the consulting engineers and architects that Cintec was the best solution with the lowest risk. Only Cintec was able to offer a high strength stainless steel anchor body coupled with a purely cementitious grout which was controlled by a woven sock to prevent its escape. Trial installations and tests were undertaken before Cintec's accredited installer, Australasian Concrete Services Pty Ltd was contracted to place over 4 km of Cintec anchors.

The aim of the repair and reinforcement work was to turn the building from a brittle to a ductile structure, able to resist future earthquakes. Cintec anchors were used to reinforce walls and piers, horizontally and vertically. Some steel frames were used where they could not be seen, behind parapets and in the tower.

Cintec anchors used on the project ranged from 215 mm long RAC cavity ties to 32 metre long anchors in the nave walls which were manufactured from 32 mm diameter "Hi-proof" grade 316 deformed stainless steel bar. All the long anchors had to be manufactured on site, with long vertical anchors being installed by crane.

The 32 metre anchors were the longest ever installed by Cintec and amongst the longest in the world.

Water could not be used for drilling because of the damage it could do to the building, so all drilling was carried out with non-coring, polycrystalline diamond bits using air for cooling and cuttings removal.



Down-the-hole video was used to verify the integrity of all drill holes and each hole was surveyed for its full length using techniques specially developed on site by the surveyors.



20 m vertical anchor being placed by crane in the project which saw anchors up to 32 m horizontally, Cintec's longest to date.

CASE HISTORY

ADELAIDE HIGH SCHOOL AUSTRALIA

SEISMIC UPGRADE



Adelaide High School (formerly Adelaide Boys' High School) is situated in parklands on Adelaide's West Terrace. It was built in the 1940s and is noted as "the first mainstream International style" building in Adelaide.

The building is noteworthy for its internal finishes as well as its external appearance. Heritage requirements for seismic strengthening in accordance with State Government policy would not allow the introduction of additional framing members and seemed an insuperable problem until Cintec Australasia was able to provide a *Cintec Solution*.

The building is of cavity brickwork with a 60 mm cavity between the two skins. Cintec designed a system which passes Cintec anchors down through the cavities and through holes in the intermediate slabs. An extra large Cintec sock expands laterally in the cavity allowing the anchors to form a reinforced band in the brickwork to provide the necessary framing action. Cavity bridging was not considered an issue due to the imperviousness of the Cintec grout.

All anchors are made from Grade 304 stainless steel deformed bar and comprise 12 mm, 16 mm and 5x8 mm Multibar anchors. Cintec RAC8 remedial cavity ties are used adjacent to the vertical anchors to prevent the cavity widening during main anchor inflation and to ensure the bond is maintained between the anchor and the two leaves of brickwork.

Anchors are up to 12 metres long with a total length of more than 700 metres. In some locations pairs of anchors placed 200 mm apart were required to give the required steel section. The long anchors presented a particular design problem as stainless reinforcing bar is only available in lengths up to 6 metres and couplers would have not fitted in the very small holes (60 mm to coincide with wall cavities). Cintec's innovative Multibar anchor came to the rescue. The grout delivery tube is ringed with small diameter bars, saving space, and couplers do not require increased hole sizes.



Anchor being inserted in protection sleeve in cavity – sleeve later removed



Anchor sock expansion where bricks removed for inspection

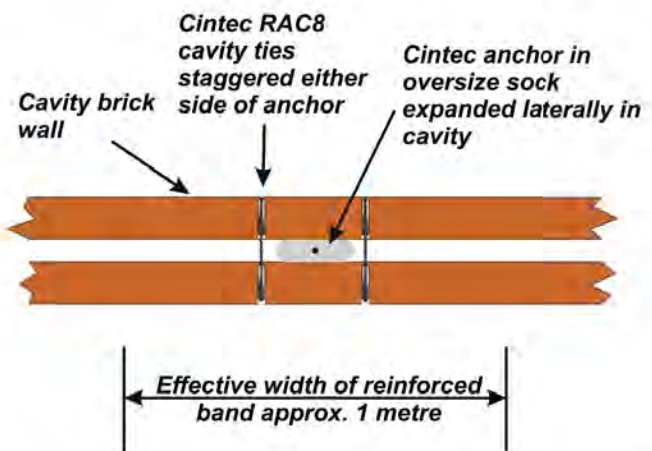

CASE HISTORY

STATE LIBRARY OF SOUTH AUSTRALIA, ADELAIDE



The State Government of South Australia has commenced a programme of upgrading public buildings to meet earthquake code requirements: Adelaide experienced an earthquake in 1954 which, whilst causing no serious damage, made the city more aware of the dangers from earthquakes in Australia than most other areas.

Adelaide is noted for its fine 19th century buildings and one of the most attractive of these is the State Library of South Australia in North Terrace.

The ground floor of the building is supported over the basement by brick vaulting topped by a thin layer of unreinforced concrete. Clearly, this floor would be liable to collapse in an earthquake. The adopted solution was to place Cintec anchors in both directions at the ends of the building with transverse tie-rods elsewhere: the anchors were fabricated from 25 mm stainless steel "Grip-Bar" and were 19 metres and 15 metres long.

In some locations, following removal of the timber flooring, it was found that the brick floor was much shallower than originally measured, and too thin to drill safely. The anchors were able to be placed in channels sawn in the floor, still managing to achieve the required bond with the brickwork and yield the composite action required. Yet another instance of the versatility of the Cintec anchoring system was demonstrated.



Taiwanese Temple

Constructed in an area of seismic activity, previous earthquakes have taken their toll upon this brick built Taiwanese temple. Some form of remedial work was clearly necessary. With their extensive experience in this field, Cintec has provided the ideal solution; by August 2003, Cintec will supply 720 metres of M16 studding anchor installed in lengths of between 5 and 15 metres. These anchors, located both vertically and horizontally, will both repair the damage previously incurred, and furthermore act as a semi-flexible steel skeleton within the masonry fabric enabling the structure to better survive future seismic events.

The temple is of high architectural and historical importance. The Cintec solution not only fulfills the engineering requirements, but because it is 'invisible' when installed, there will be no visible change the temple's original appearance.



Hard Brick Construction

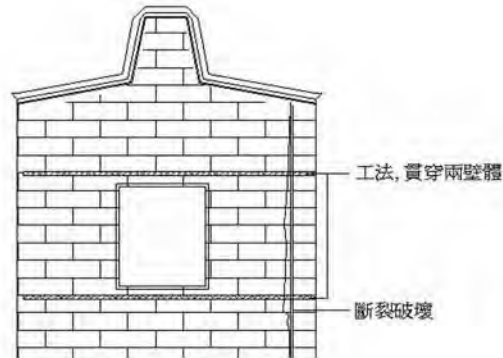

- 工法
- 碳纖維版工法

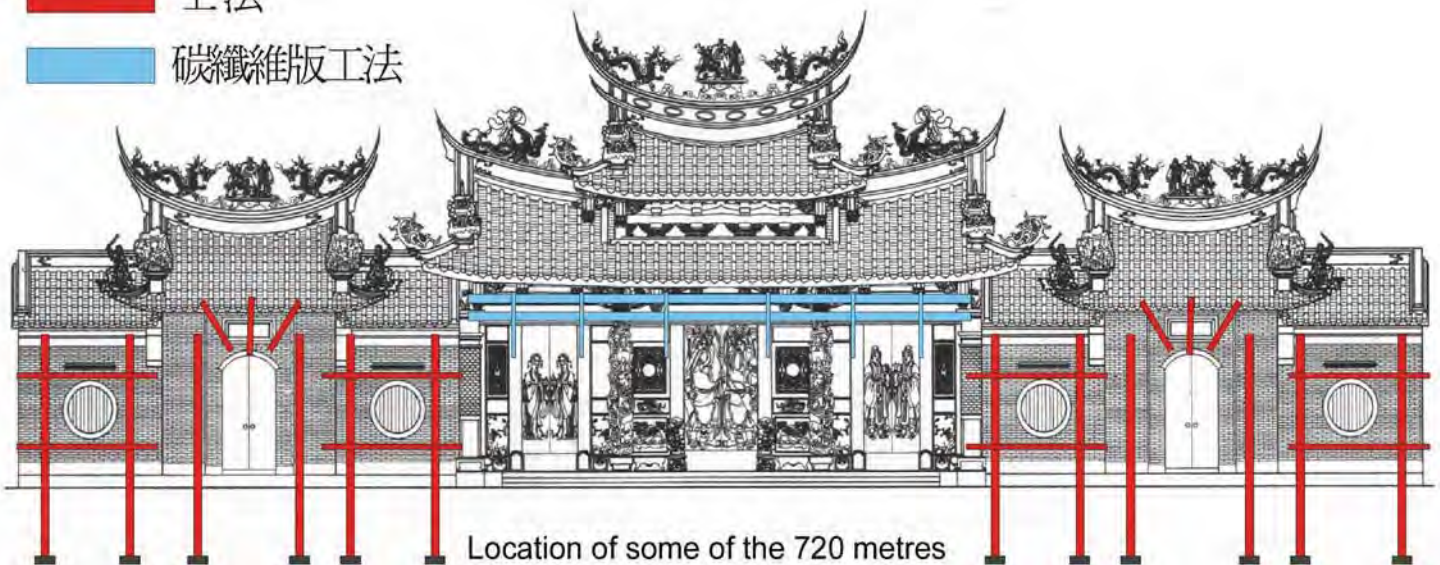

Location of some of the 720 metres of M16 studding anchors to be installed

European Parliament



Cintec International Limited

European Parliament Building Athens—Greece

Project:

Restoration of the damage to the
European Parliament Building.
After the earthquake of September 1999

Study:

Grigoris Hatzidimitriou—Architect
Nikos Hatzikiriakos—Architect

Civil Engineers:

H. Kirpotin & Co. Consultants

Engineer:

Manolis Kokkinakis

Main Contractor:

Edrasis - C. Psallidas S.A.

Drilling & Installation Contractor:

Cintec International Limited

Project Manager: Dennis Lee

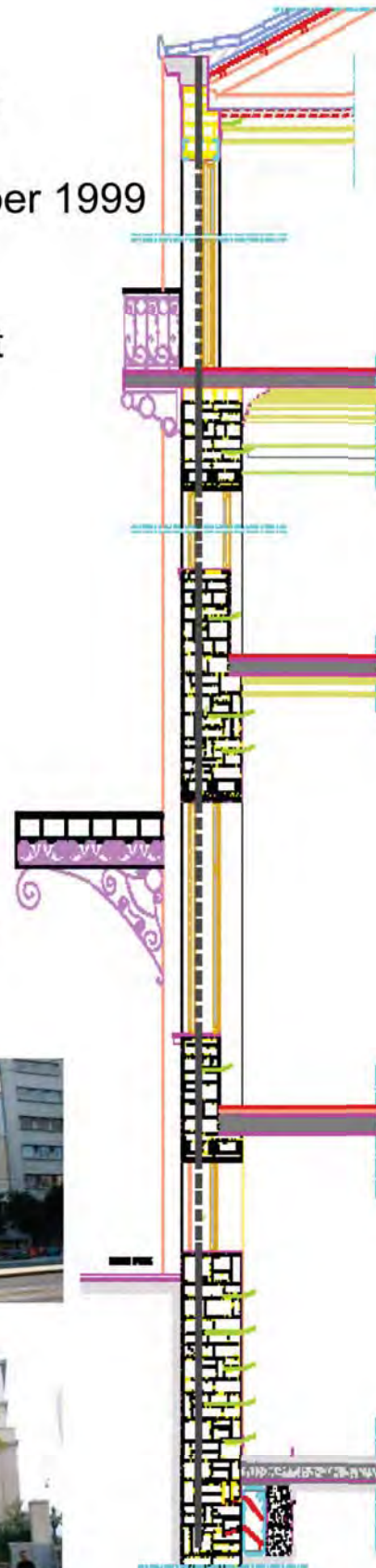

CASE HISTORY

101mm diameter vertical holes were dry diamond drilled to a depth of 23 metres from the roof line into the foundations. 32mm diameter stainless steel ribbed bar Cintec anchors were then installed. These were combined with horizontal Multibar 25mm ribbed anchors at each floor level, to form an internal reinforcing steel framework.

The Cintec socked system prevented grout penetrating the building through numerous cracks and damaging the ornately decorated walls and ceilings.

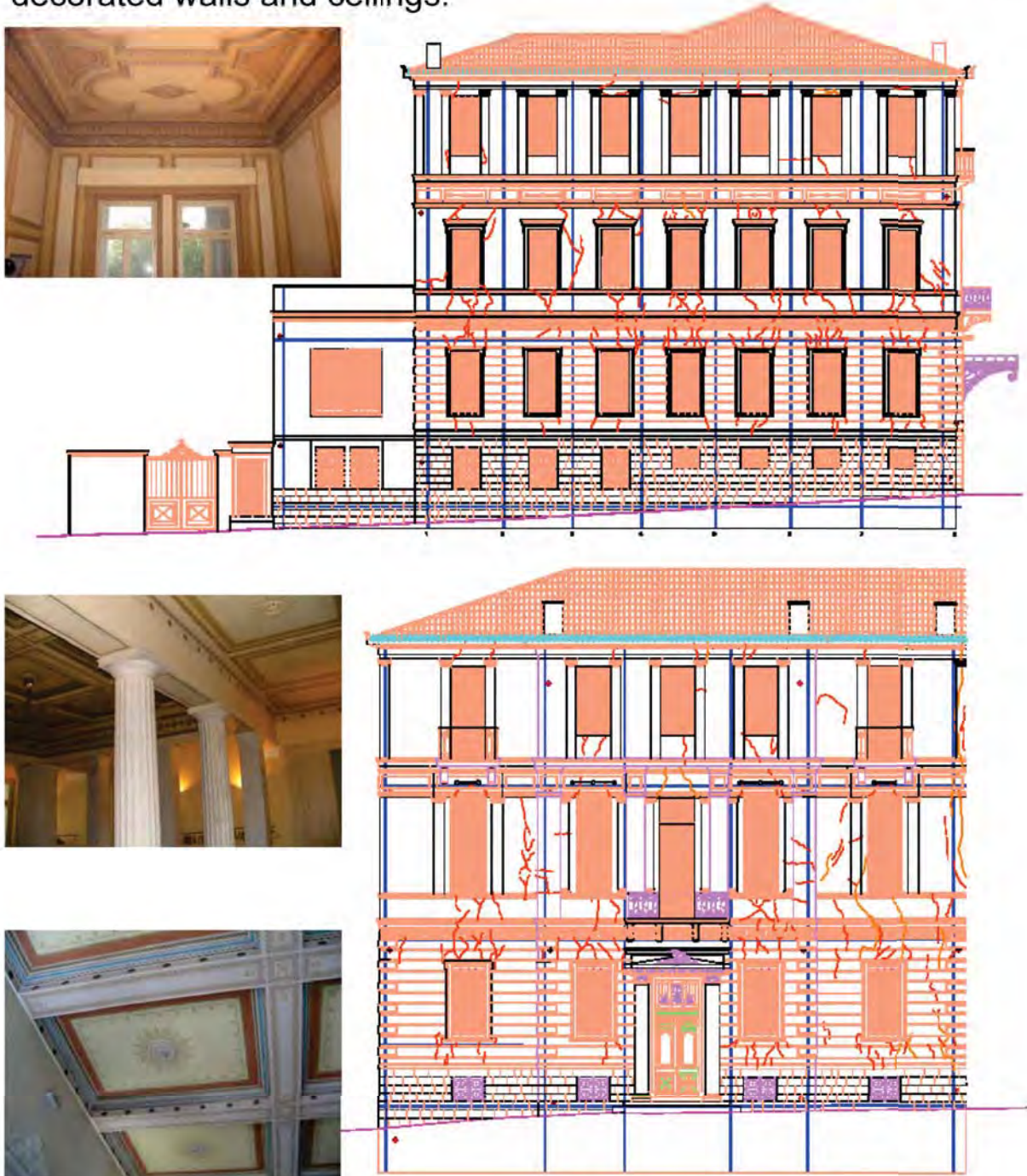

CASE HISTORY



Horizontal holes were dry drilled through hard limestone random rubble walls using 86mm core barrels on lengths up to 10mts and 101mm core barrels for the longer lengths, these were reinserted after drilling to facilitate the anchor installation.

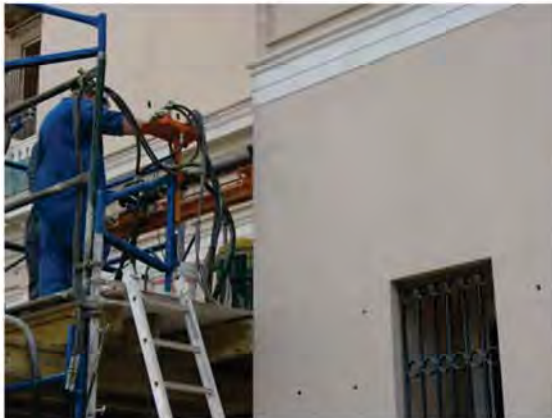

The dry drilling used compressed air as the cooling and flushing medium. Heavy duty vacuum extractors were used to minimise dust levels, both internally and externally.



CASE HISTORY



Cintec Multibar anchors comprising two 25mm ribbed stainless steel bars were assembled in sections to achieve anchor lengths up to 29 metres. Each anchor had integral plastic spacers, to ensure centralisation of the anchor along its length, within the drilled hole.

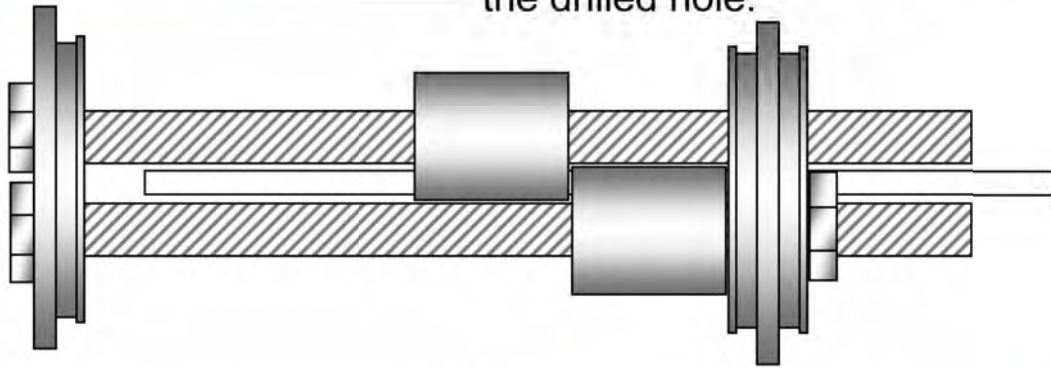

CASE HISTORY

Vertical holes dry diamond drilled.



CASE HISTORY

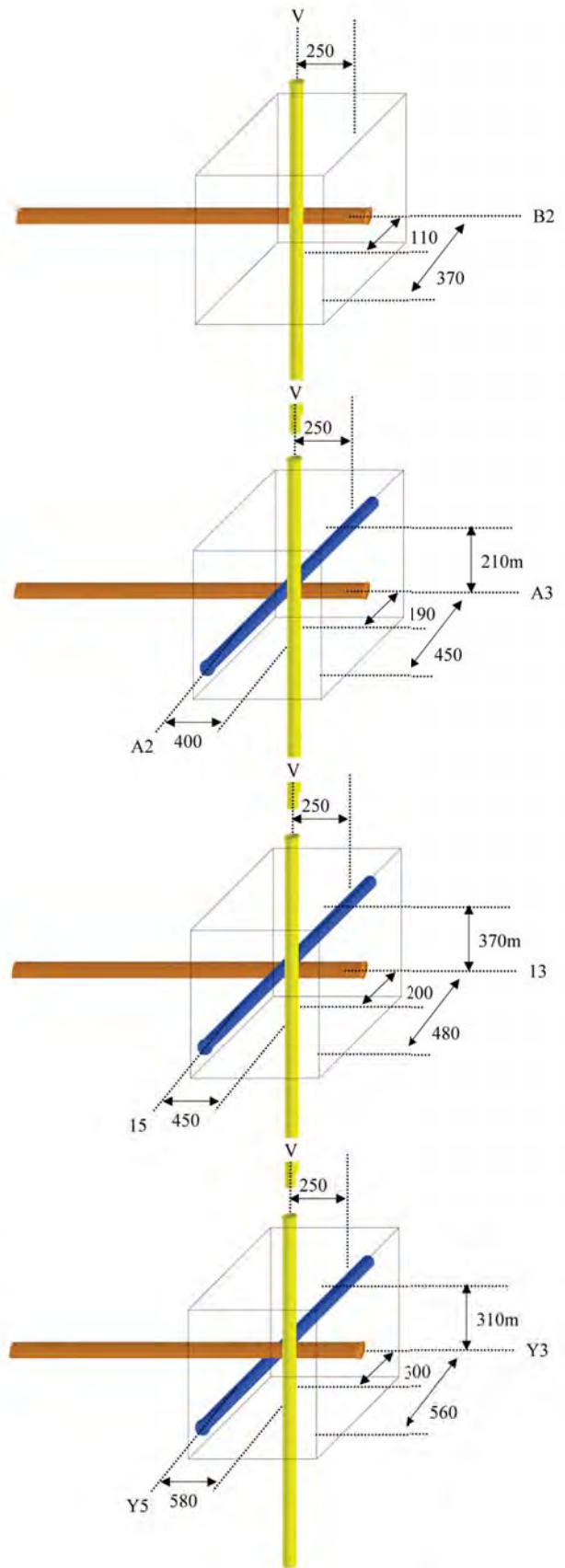

Anchor positions were carefully marked out and drilled with extreme precision to avoid intersecting anchors.

CASE HISTORY



PRINCES' GATE

TORONTO ONTARIO CANADA

The eastern entrance to Exhibition Place is marked by the Princes' Gates, a beautiful structure named for Edward Prince of Wales (later Edward VIII), and his brother Prince George (later The Duke of Kent). Often mistakenly called the "Princess Gates," the monumental Princes' Gates were built to celebrate Canada's 60th anniversary of Confederation (1927). The gates are made of a mix of stone and concrete. There are nine pillars to either side of the main arch, representing the nine Canadian provinces in existence at the time of construction. Flanking the central arch are various figures representing progress, industry, agriculture, arts and science. The gates were designed by Chapman & Oxley in Beaus Arts style and in 1987 the gates officially became a listed building under the Ontario Heritage Act.

Cintec had already provided anchoring solutions for other historic buildings within the vast Exhibition Place complex. Naturally, when R. O. (Rick) Coombs of Nexus Architects and Tony Serafico of Clifford Restoration Limited were tasked with the seismic issues relating to the columns, they turned to Cintec.

Each column consists of several, tapering, annular rings stacked to a height of 27 feet and sit on a concrete pile cap some 7 feet thick. The project required an anchor that would extend the full depth of the column and pile cap, mechanically and adhesively tie all components together and allow post tensioning load of 25,000 pounds per column.

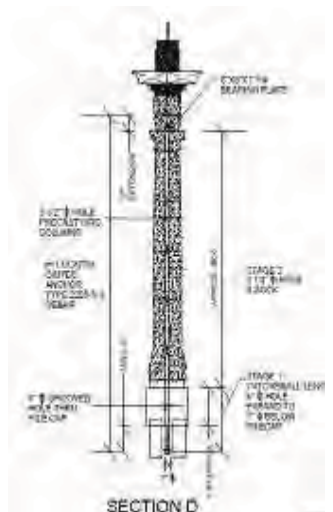

The annular rings had a 3 inch centre hole precast and the centre of the pile cap was precision cored 4 inch diameter by Davis Structural with a PCD type bit to give a 1/8" X 1/4" groove for improved attachment. Two stage anchors, 35 feet long were fabricated by Cintec, each comprising #9 carpenter stainless steel, 4" diameter polyester Cintec sock for the 7 foot first stage and 3" diameter sock for the second stage.

The anchors were carefully lowered into place by crane and the first stage inflated using Cintec Presstec® grout. After 7 days, tension load of 25,00 lbs. was applied, bearing plate secured and the second (27 foot) stage was inflated.

ARCHITECT
NEXUS ARCHITECTS
214 Merton St, Suite 208
Toronto, Ontario, Canada
1 416 962 8047

CONTRACTOR
CLIFFORD RESTORATION LIMITED
86 Mack Avenue
Scarborough, Ontario, Canada
1 416 691 2341

Every day Applications including Fire Damaged Buildings ,Readaptive use of Buildings & structures, Monument & Chimney Repairs, Historical Restoration ,Stud and Nelson Stud applications , Cost Saving applications & Unusual applications



CASE HISTORY

THE BRUNSWICK TOWER, WINDSOR CASTLE – ENGLAND, U.K.



Windsor Castle has been a Royal residence for over 900 years and is an official residence of Her Majesty the Queen.

At 11.37 am Friday November the 20th 1992, fire broke out, and much of the Castle was devastated by the raging inferno that ensued.

The fire raged all day and at 6.30 pm the Brunswick Tower was engulfed. The intense heat caused the castellated section of the Tower to fracture, with the possible risk of collapse.

Initially there seemed little choice but to dismantle and rebuild the top section of the Tower. However the versatility of the Cintec Anchoring System enabled the engineers to design a repair solution that restored the structural integrity without further disruption to the unstable stonework.



▲ Photographer: David Giles / PA News



▲ Photographer: PA News

Throughout the damaged areas of the Castle Cintec Anchors were used to restore the integrity of the walls and provide repair and strengthening solutions to this magnificent Heritage Building.

CASE HISTORY

THE BRUNSWICK TOWER, WINDSOR CASTLE – REPAIR

The latest Diamond Drilling Techniques were used to create a network of holes within the stonework.

The Cintec Anchors were then installed creating a reinforcing ring, within the fabric of the stonework, maintaining the original appearance of the Tower.

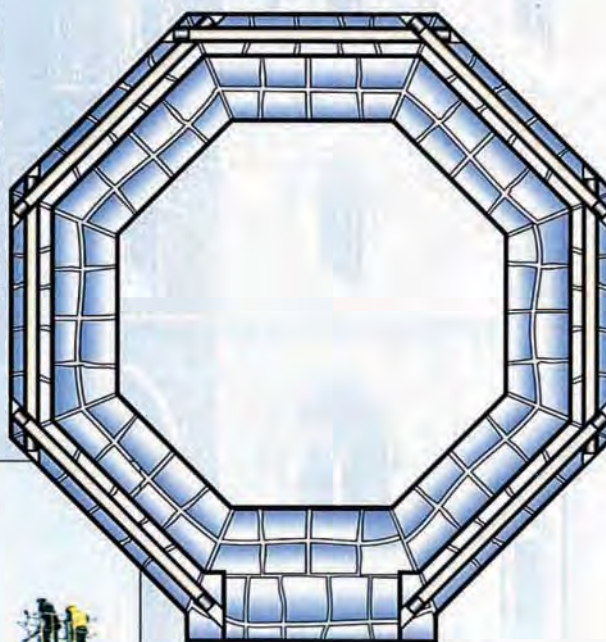
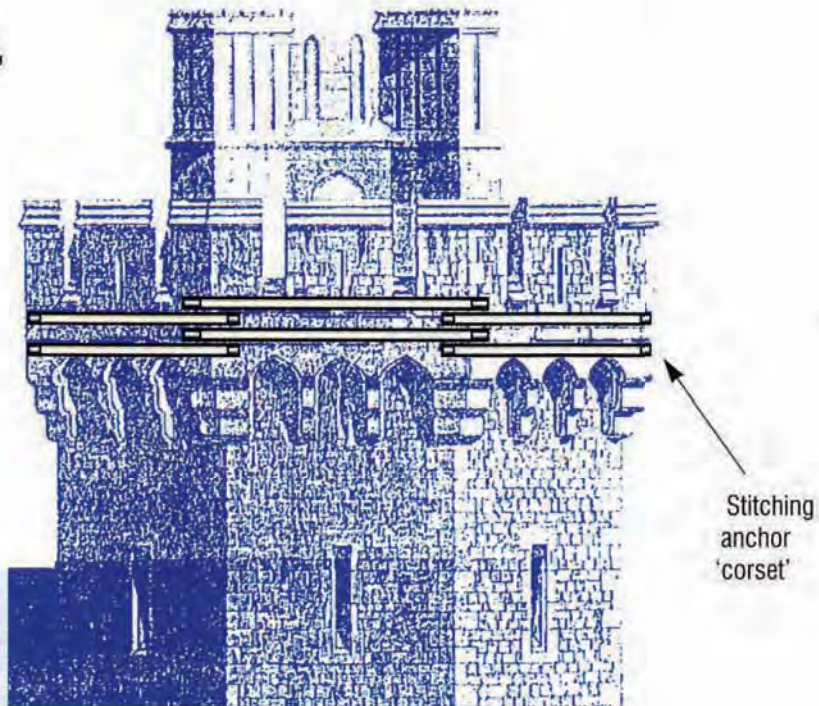

The illustration shows the arrangement of anchors used in the restoration of the Brunswick Tower.



▲ Photographer: Fiona Hanson/'PA' News

CASE HISTORY

FULLER'S BREWERY, LONDON U.K.

TRIAL BY FIRE



Cintec anchors were put to the test in two ways at the Fuller's Brewery in London. First anchors were used in major structural repairs to the Brewery. However, the unique qualities of those anchors were clearly demonstrated in the second test - when the Brewery was destroyed by fire.



Remedial anchors installed prior to the fire. The anchors are still functioning. The grout cover protected the main steel body of the anchor.



Even though the brickwork had been subjected to extreme temperatures, the anchors survived well; pull out tests revealed that they still performed to their original design specification.



CASE HISTORY

FULLER'S BREWERY, LONDON U.K.

The Anchor System had been used extensively to repair and restore the terrace of the listed Georgian building when the premises were vandalised. A fierce fire followed, destroying large sections of the buildings.

Despite being subjected to extremely high temperatures, tests revealed that the cementitious Cintec anchors did not fail. They retained their integrity and could be reused for the repair work. Had a resin alternative been specified they could have melted. In point of fact, where anchors were installed, there were no cracks in the structure. However where there were no anchors there were distinctive signs of distress due to the intensity of the fire.

Robert McAlpine undertook the original project to restore the property. An investigation by the project engineers, the Brunel Partnership, identified a need to stabilise the front wall which had become debonded from the party walls and repair brickwork that was delaminating.

Structural repairs prior to the fire were designed by John Wardle and carried out by WT Specialist Contracts. Restoration included using 15 x 15 square hollow section anchors to tie the front wall back to the party walls. To tie the brick piers on the facade into the floor, anchors were also installed at each storey level. Remedial anchors were used to repair the delamination of the brickwork.

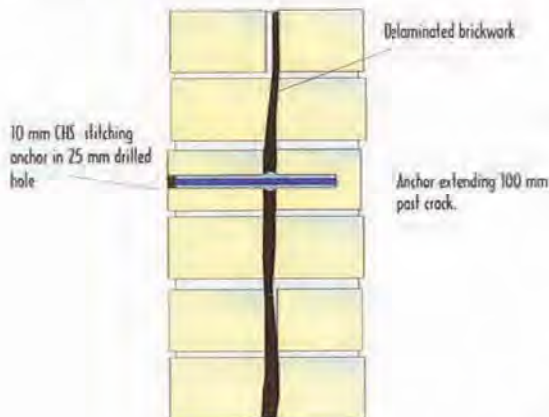

fig. 1

Even though the floors had been destroyed by the fire and the brickwork had been subjected to extreme temperatures, the ties had survived the fire well even in the walls worst affected.

At the time of the fire 95% of the ties were in place with only a small number of RAC wall ties still needing to be fixed to repair the brickwork. The immediate concern to the Brunel Partnership following the fire was to stabilise the remaining building fabric with temporary propping. Having

15 x 15 mm SHS stitching anchor 1500 long installed in a 32 mm drilled hole.

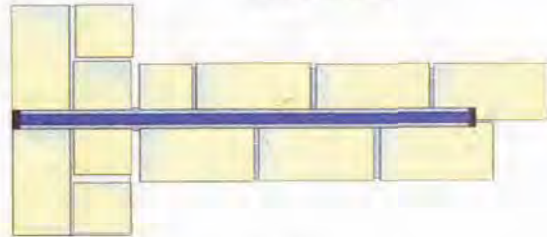

fig. 2

completed that the original anchors were examined to determine if they could still function and achieve their designed performance.

Pull-out tests on the 15 x 15 square hollow section anchors were undertaken to 9KN. Further loading was not applied as a failure of the brickwork could occur while the building was unstable.

After the fire the proposal was to consolidate all delaminated brickwork (fig. 1) using Cintec RAC anchors, allowing repairs of the internal delaminated skin to be undertaken without risk of further failure to the masonry. At the same time the major cracks were stabilised using Cintec SHS anchors (fig. 2).

The final remedial work included stabilising the brick arches and providing new seating for floors.

However, it is the 'real' fire test which will be of great interest to engineers and organisations using Cintec anchors. It has proved that the anchors have outstanding resistance to the effects of fire.



Text: John Wardle BSc. Eng./Construction Repair

Marriott Hotel. Liverpool Airport



The Marriott Hotel was once the old control tower and terminal building for Liverpool Airport. With increased demand two new wings have been added in the same Art Deco style.

However in order for pedestrians to access the new development the two existing circular staircases needed to be extended through approx 140° and also rise by approx 750 mm (30 inches).

The Architect did not wish for the cantilevered `I` beams to be bolted to the brick wall with conventional end plates as they would remain visible and so the contracted engineers and Cintec produced a design of casting them in.

A 200 mm (8 inch) diameter, 450mm (18 inch) deep hole was hand cored by diamond drilling into the brickwork. All the 100 x 100 (4x4) `I` beams were fixed to supporting scaffold after insertion and leveled by surveyors.

The work was carried out in 2000 by the Liverpool branch of Terminix. Formerly Peter Cox.



Insertion of Cintec anchor section of `I` beam into brickwork



`I` beam following anchor grout injection

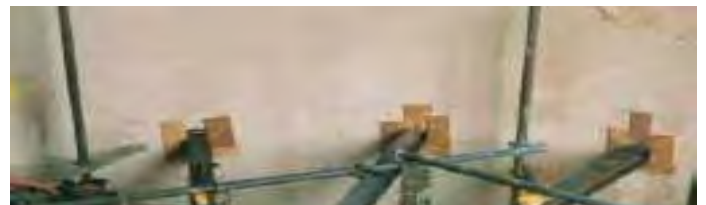

All installed `I` beams leveled and supported as grout Hardens

COBWEB BRIDGE - Sheffield UK



Situated in the city of Sheffield, the cobweb bridge was constructed to extend a riverside walkway known as the Five Weirs Walk, down the River Don to below the Wicker Arches Viaduct. The 'Wicker Arches' is a Victorian railway viaduct in the center of the city. The space below each arch is used by workshops of various sorts, all apart from the one spanning the River Don.

In order to extend the walkway, the Five Weirs Walk Trust requested that a footbridge be suspended under the arch spanning the River Don, its construction would avoid a one-mile detour. The City Council consulting engineers Sheffield Design & Property, were engaged to design and supervise the construction.

Completed mid 2002, the footbridge is suspended from cables fixed into the arch stone work with over 120 Cintec Stud anchors with heavy duty eye-nut attachments, the design of the anchor was determined after extensive testing, and the drilling was carried out to match the angle of the cable to avoid bending moment. The cobweb Bridge is so named not only because of the web-like mass of cables from which it suspends but also because the installation of two lighting rigs, suspended from the arch crown by Cintec anchors, are shaped like giant spiders.

The anchors were installed by JHM (Drilling & Grouting) of Doncaster sub-contractors to the main contractor - Thyssen.

The Wicker arches are an English Heritage listed structure designed by Sir William Fowler, the designer of the famous Forth Rail Bridge.



View of the supporting cables under the arch after lifting bridge from supporting scaffold.



Upper Fixing Detail - Cintec Stud Anchor with Eye Nut attachment.



Lower fixing detail with turn buckles.

CASE HISTORY

DON VALLEY BRICKWORKS CHIMNEY RESTORATION, TORONTO, ONTARIO, CANADA

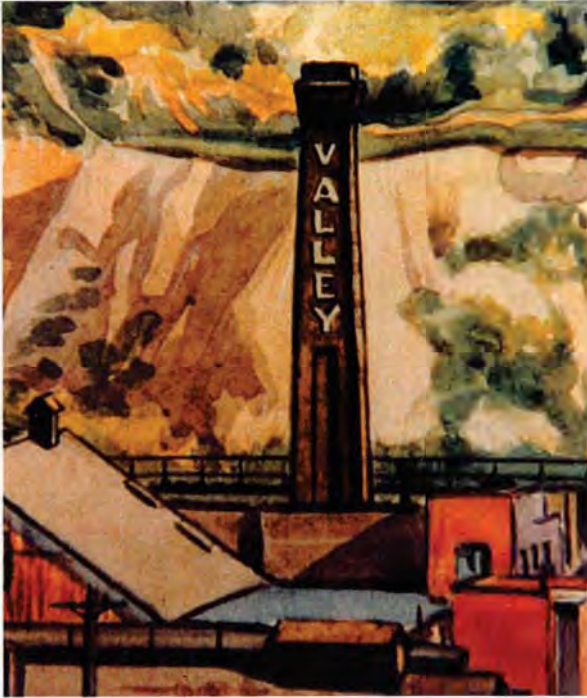

Don Valley Brickworks Contemporary Illustration

10,000 years ago in the Don Valley near Toronto, the last glacier in the area laid a deposit that formed the foundation, aeons later, for the production of clay bricks in the Don Valley Brickworks. Many of those bricks formed the basis of old buildings in Toronto. But the Brickworks fell into disuse and ruin with a sole remaining chimney marking the place of the old heritage site. McGillivray Architects were selected to restore it.

The Chimney, built in about 1890, had serviced three adjacent downdraft kilns. The shaft had been deteriorating through the years and had become a pigeon roost! Significant cracking appeared on the east and west elevations and it was found to be leaning almost 43 inches to the south and a bit to the west. The corrective action was to stitch two sides together using the Cavity Lock Systems Ltd (CLS) Cintec Anchoring System. The CLS Cintec Canada Company had had previous experience in similar projects obtaining excellent results in what is truly corrective surgery on buildings. The restoration work also included substantial repointing and some brick replacement.

Architects :
McGillivray Architects

Structural Engineers :
Halsall Associates Ltd

Contractor :
Ontario Restoration Ltd

Cintec Approved Contractor :
General Concrete and Cutting Ltd

Clients :
Metro Toronto & Region Conservation
Authority who said :

"Over a year ago, when we first addressed the restoration and stabilisation of the chimney, we could not have foreseen the level of effort and commitment required to complete this task.

However, the success achieved over these last few months has clearly demonstrated that the product was well worth the effort."



Chimney Restoration
In Progress

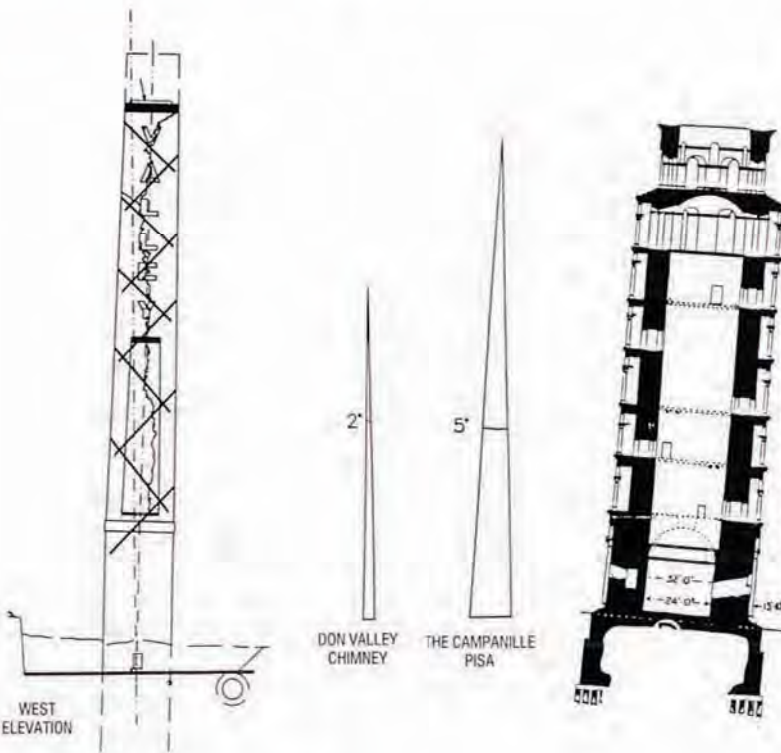

Drawing of the Don Valley Brickworks Chimney in relation to the Leaning Tower of Pisa

CASE HISTORY

YARRALUMLA BRICKWORKS CHIMNEY S3

The Yarralumla brickworks was established in 1913 soon after the founding of Australia's national capital, Canberra, and was the source of most of the bricks used for the city's buildings for more than 60 years. Important historic buildings such as Old Parliament House (1927) and the Kingston Power Station were among the many large buildings built using the bricks.

Until 1950 the kilns used short brick chimneys with forced draft, following the design guidelines of Canberra's designer, Walter Burley Griffin, which required such structures to be shorter than the pine trees that were being planted throughout Canberra. However the post-war building boom required a large capacity increase and it was decided to equip the new kiln with a 150 ft (46 m) tall natural-draft chimney.

Following the closure of the brickworks, the land was partly subdivided for housing and new residences were built, including some only a short distance from the tall chimney. Subsequently the chimney was recognized as having heritage significance, being the only such one built in Canberra, but it was allowed to deteriorate, the lightning protection system was vandalized and lightning strikes shattered brickwork at the top.

Cintec's Australian representative, Bill Jordan, was engaged to provide conservation advice and structural analysis for the chimney.

In the first phase of work the lightning protection was repaired and upgraded and the lightning damaged brickwork at the top of the chimney was stitched together using Cintec CHS10 anchors up to 2.2 m long. The chimney was fully scaffolded for this operation and the opportunity was taken of testing the brickwork to provide data for the subsequent strengthening.

Analysis showed that the intact chimney was strong enough to resist design wind actions but not earthquake actions. The risk of earthquakes in Canberra, whilst low, is still significant especially when the consequences of structural failure on the nearby buildings are recognized. A



number schemes of strengthening were considered, including drilling and Cintec anchor installation for the full height. In the end the adopted scheme used an internal steel frame. Tolerances in steel fabrication and the difficulties of accurately measuring the chimney meant that the frame had to be designed to be clear of the structure by up to 120 mm. Structural continuity between the steelwork and chimney was accomplished by using Cintec 30x30 mm SHS anchors which had sufficient moment and shear capacity to effect the force transfer. The frame was designed to form its own scaffolding as it rose, so saving the very large costs involved.

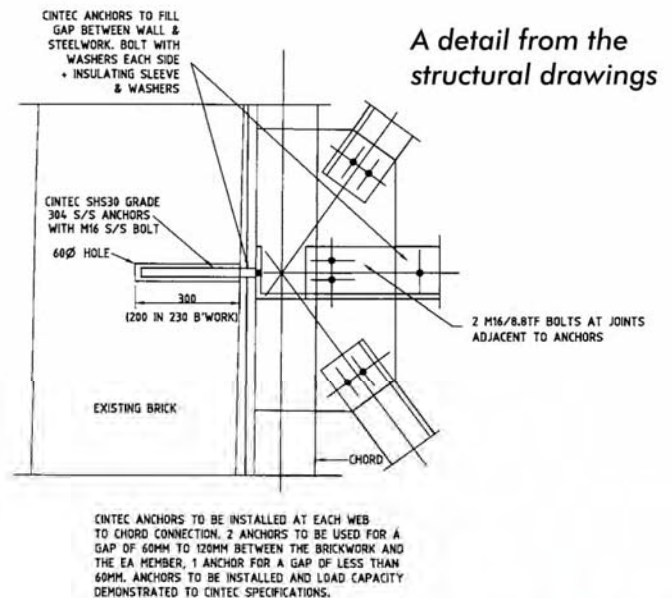

CASE HISTORY

Chimney & Monuments Restoration

Guisborough Hall Hotel, Chimney

Guisborough Hall is being renovated to provide high-class apartments: Balast Construction is carrying out the renovation with some care, as it is a listed building.



Glyn Robinson Associates were retained to provide structural design elements and their main problem was the wind loading on the 2.6 & 3.1 Mt. high chimneys. Only seven of these 18th century octagonal chimneys out of the total of 44 would be used. Cintec proposed a specially designed anchor to create a reinforced concrete column inside the chimney, bonded to the pot liner (where there was one). This anchor consisted of 4 – 12mm stainless steel rebar anchors in a 250 mm dia sock for the 300 mm flues.

CASE HISTORY

Chimney & Monuments Restoration



Partially missing ceramic liner ->



Chimney's capped with a stainless plate. ->



CASE HISTORY

STONEY CREEK, ONTARIO, CANADA

Restoration of the 100ft (30m) Stoney Creek battlefield monument by the installation of cementitious grout anchors

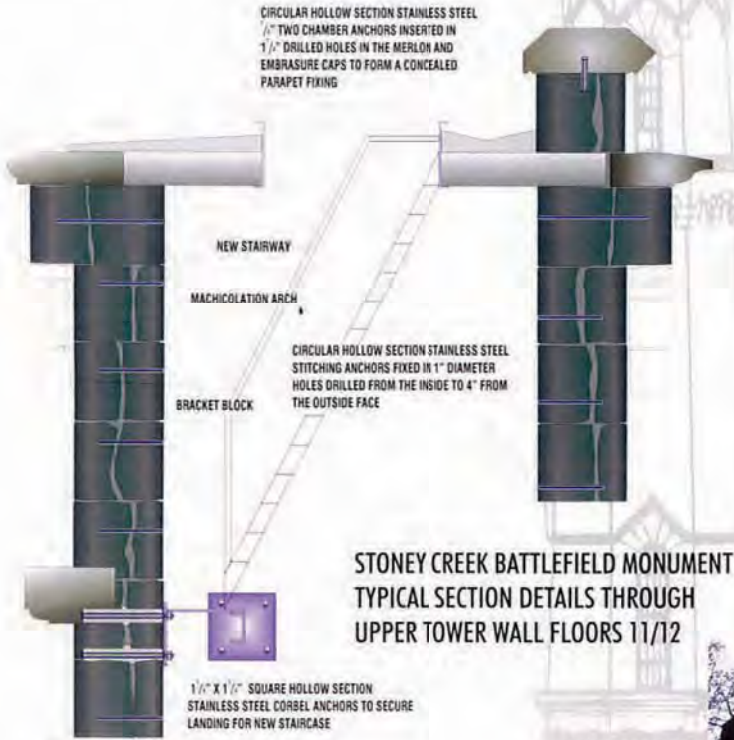

STONEY CREEK BATTLEFIELD MONUMENT
TYPICAL SECTION DETAILS THROUGH
UPPER TOWER WALL FLOORS 11/12



The Stoney Creek Battlefield Monument is the centrepiece of Battlefield Park and was erected in 1913 exactly 100 years after the battle for which it is named. It was here that the British repelled an invading American force. The Restoration of the monument was executed by architect Alan Seymour. It consists of a slender stone tower, 100ft high, going from a castellated and tunnelled blockhouse sitting atop a steep slope approached by a monumental flight of steps. Unfortunately the monument was showing conspicuous signs of deterioration. The restoration included the installation of Cintec cementitious grout anchors to stitch the severely cracked inner and outer wythes of the lower walls. A total of 526 such anchors were used ranging from 12 to 31 inches long (305 to 790 mm), on a 2- x 4- foot (0.6 x 1.2 m) staggered grid. Following installation of the anchors, 54 cubic feet (1.53 cu.m) of conventional grout was injected. CLS Cintec Canada Ltd. provided the anchor system which will maintain the monument's structural and architectural integrity well into the next century. The citizens of Stoney Creek now enjoy their splendid monument in its full glory.

CASE HISTORY

Old Parliament House, Canberra Australia



Old Parliament House in Canberra served as the “temporary” seat of Australia’s federal Government from its opening by the Duke of York (later King George VI) in 1927 until the opening of the new building on the hill behind it in 1988.

The building was built of brick, cement rendered internally and externally, with some of the render being up to 30 mm thick and in up to three layers. During the buildings conservation for its new use as a parliamentary museum, it was found that much of this render had lost adhesion and was “drummy” yet it was worthy preserving as a record of techniques used in its application and the history of painting contained on its surface. The project managers were particularly concerned to ensure that the render could not fall on users of the building.

Standard techniques using various proprietary adhesive injection techniques were tried on a test panel from which the render was then cut to reveal that none were adequate. Two problems were apparent.

- The adhesive resins were absorbed into the bricks or the render, but often did not bridge the gap:
- The loss of adhesion in the render was a different layer boundaries which meant that a large area of “drummy” render did not have one large void but separate voids at different levels.

Eventually CINTEC came up with the option of pinning the render in place with the use of a grid of 75 mm long CINTEC RAC anchors. The anchors were inserted through the render into the underlying brickwork, but left protruding at the surface so that the sock-encapsulated grout bound the full depth of the render layers: the CINTEC “pins” were trimmed after hardening and the hole repaired.

Work is continuing as the building is conserved.

CASE HISTORY

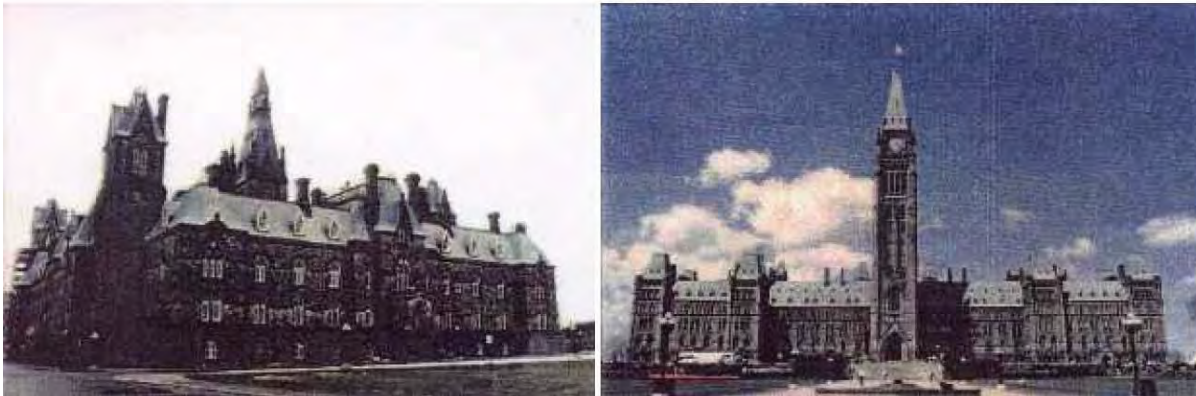

The Canadian Parliament

The Centre Block of the parliament buildings accommodates the House of Commons and the Senate. All Canadian law originates here. The original building was constructed between 1860 and 1865. After the fire of February 1916, which totally destroyed the building except for the library, the building was rebuilt of Nepean Sandstone.

The West Block, also constructed in 1860, was added to in 1878 and has also seen a major fire which in 1897 damaged the top stories. Today the building contains the offices of the members of Parliament and staff, together with the Confederation room which is used for some state occasions. Major repair and restoration work has been carried out to ensure that these historic buildings continue to serve Canadians for many years to come. CINTEC was involved in major repair to both these buildings. Walls of the Senate Tower were stabilized above the roof level using 5 metre-long fully socked 12mm and 16mm dia. threaded rod anchors. Gargoyles on the four corners were stabilized with anchors drilled from the inside of the tower into the back side of this prominent architectural element.

Pavilion walls on the south side of the building were secured to the floor diaphragms using 4 metres long anchors installed through three steel floor beams, and pairs of diagonal anchors. The anchors were modified on site to suit the condition of the floor structure. Chimneys on the south side of the Centre Block roof are being secured to the roof structure using long anchors through the chimney. The anchors either end in attic walls or expand around steel roof beams.

CASE HISTORY



PRINCES' GATE

TORONTO ONTARIO CANADA

The eastern entrance to Exhibition Place is marked by the Princes' Gates, a beautiful structure named for Edward Prince of Wales (later Edward VIII), and his brother Prince George (later The Duke of Kent). Often mistakenly called the "Princess Gates," the monumental Princes' Gates were built to celebrate Canada's 60th anniversary of Confederation (1927). The gates are made of a mix of stone and concrete. There are nine pillars to either side of the main arch, representing the nine Canadian provinces in existence at the time of construction. Flanking the central arch are various figures representing progress, industry, agriculture, arts and science. The gates were designed by Chapman & Oxley in Beaus Arts style and in 1987 the gates officially became a listed building under the Ontario Heritage Act.

Cintec had already provided anchoring solutions for other historic buildings within the vast Exhibition Place complex. Naturally, when R. O. (Rick) Coombs of Nexus Architects and Tony Serafico of Clifford Restoration Limited were tasked with the seismic issues relating to the columns, they turned to Cintec.

Each column consists of several, tapering, annular rings stacked to a height of 27 feet and sit on a concrete pile cap some 7 feet thick. The project required an anchor that would extend the full depth of the column and pile cap, mechanically and adhesively tie all components together and allow post tensioning load of 25,000 pounds per column.

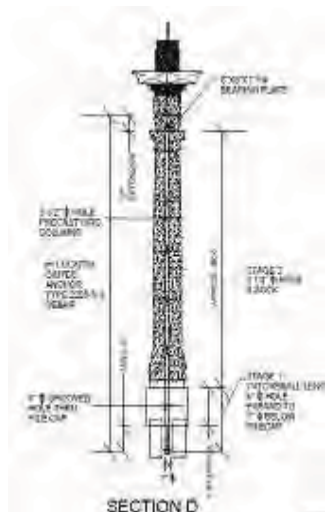

The annular rings had a 3 inch centre hole precast and the centre of the pile cap was precision cored 4 inch diameter by Davis Structural with a PCD type bit to give a $\frac{1}{8}$ " X $\frac{1}{4}$ " groove for improved attachment. Two stage anchors, 35 feet long were fabricated by Cintec, each comprising #9 carpenter stainless steel, 4" diameter polyester Cintec sock for the 7 foot first stage and 3" diameter sock for the second stage.

The anchors were carefully lowered into place by crane and the first stage inflated using Cintec Presstec® grout. After 7 days, tension load of 25,00 lbs. was applied, bearing plate secured and the second (27 foot) stage was inflated.

ARCHITECT
NEXUS ARCHITECTS
214 Merton St, Suite 208
Toronto, Ontario, Canada
1 416 962 8047

CONTRACTOR
CLIFFORD RESTORATION LIMITED
86 Mack Avenue
Scarborough, Ontario, Canada
1 416 691 2341

CINTEC

in the
CARIBBEAN



La Fortaleza [Governors Residence] Puerto Rico



Real Audencia [post Earthquake] Puerto Rico



Puente Laguna Condado San Juan Puerto Rico



The Restoration of Arlington House [the oldest property]
In Speightstown Barbados



East India House [Governors' Residence] US Virgin Isles



Queens Royal College Port of Spain Trinidad

THE SALVATION OF HIBIS TEMPLE EL-KHARGA - EGYPT



A UNIQUE ANGIO EGYPTIAN COOPERATION IN THE FIELD
OF STRUCTURAL ENGINEERING

the temple - by Dr Mustafa Ghannawy

The location of the present temple is, most likely, a holy site of previous temples that may date back to the Old and Middle Kingdoms of Egypt.

Work in the present temple started during the 26th dynasty (672 BC: 525 BC).

In the days of its construction, the temple occupied a dominant location in the middle of the old city of Hebet (the plough in the ancient Egyptian language) just to the north of the present city of El-Kharga. Only a few monuments still remain of this old city.

During the Persian occupation of Egypt (525 BC: - 404 BC), King Darius I expanded the earlier Saite period temple renewing the inscriptions and adding a decorated gateway.

Additional structures were added to the temple during the reigns of Achoris (c. 390 BC), Nectanebo I (c. 380 BC, and Nectanebo II (c. 360 BC).

During the Ptolemaic Dynasty, Ptolemy II Philadelphus built the "Great Gateway" (c. 282 BC).

After the death of Nero in Rome 68 AD, four emperors ruled during one year. During the reign of one of them, Galba, a portal was added to the Hibis temple complex nearer to the landing stage on the lake.

At present the temple and its complex consist of the following:

- Landing stage on the lake.
- Avenue of sphinxes over which the Romans built the Outer Gateway. Closer in are the Ptolemaic Great Gateway and the inner gateway decorated by Darius I.
- Bases for two obelisks or statues perhaps from the time of Achoris.
- A portico built by Nectanebo I (c. 390 BC), and later rebuilt by Nectanebo II (c. 360 BC). With eight floral columns separated by screen walls it contains numerous scenes of the king offering to the gods.
- The First Hypostyle Hall built during the reign of Achoris (c. 390 BC). It contains twelve columns on substantial foundations to support the roofing blocks.
- The Second Hypostyle Hall was constructed as part of the original temple (Saite Dynasty) with renovations during the reign of Darius I (after 522 BC). The screen walls are decorated with numerous scenes where the original paint still survives.
- Third (originally) hypostyle was constructed during the Saite Period. Darius I later added painted decorations on the columns in his renovation of the temple.

CASE HISTORY



(1) The god Anubis with hieroglyphic inscription
(3) Detail of a hieroglyphic inscription and scene in plaster

(2) Sample elevation from the original 1941
Metropolitan Museum of Art's publication
(4) Example of the cartouche of Darius I

examination of Hibis Temple - by Professor Eugène Cruz-Urbe, Ph.D

a) The Sanctuary

The sanctuary (Room A) is perhaps the most fascinating room in the temple. On the three walls are inscribed essentially a catalogue of all of the deities of ancient Egypt.

Originally the rear wall of the sanctuary (west wall) was composed of a false door niche (seen in one photograph by the Metropolitan museum) and was later built over with the present nine (9) panel format and matches the nine panels on the north and south walls.

The contents of the three walls are amazing. Each panel has a series of deities, 359 in total in the sanctuary. They seem to be organized in groups representing major cult centres. Each panel begins with a figure of the king making an offering (water, food, wine, oil, clothing, land, etc.).

Most of the deities on the south wall represent the major cult centres in Upper Egypt. They start with the gods from the Philae region, followed by those from Elephantine and their progress northward skipping the deities of Thebes before going on with the deities of Middle Egypt. Of particular interest are:

Panel 1 - in the middle we see the various forms of Khnum of Elephantine. Figure of Khnum with his potter's wheel.

Panel 3 - We see the Seven Hathors. These goddesses are normally associated with the determining of a person's fate at birth.

Panel 5 - In the middle we see the deities from Hermopolis - led by the child sun god (labelled Re-Horakhty) who is shown emerging from the lotus flower at the moment of creation. He is attended by the Ogdoad of Hermopolis (ton and snake headed).

The west wall is composed entirely of the deities from the Theban region with a myriad of forms of the god Amun-Re. The top four panels are gone and only the lower ones remain. Even though a variety of gods and goddesses are depicted, the inscription by the king at the front of each panel says he is making an offering to Amun-Re.

The north wall continues a geographical list of deities from main cult centres focusing on those from northern Upper Egypt and the Memphite area. We should especially note:

Panel 3 - We find a series of figures of the goddess Astarte, including one where she is riding a horse side saddle.

Panel 7 - We see the figure of Isis suckling a crocodile.
The inscriptions at the front vary with the king offering to Amun-Re or to the great gods.

What we seem to have happening here is the worship of mainly Amun-Re as king of the gods / universal god as promoted in the Theban region, but shown by his universal character as being identified with all of the gods from all over Egypt.

The deities from Lower Egypt seem to have been added in on the reveals of the door when the sanctuary was reconstructed later in the Persian period.

Room L - The Kingship room.

This room is located just north of the sanctuary. Architecturally it is quite interesting because it contains a pillar blocking the view of some of the scenes on the south wall just inside the doorway. It would appear that the roof blocks must have been damaged (potentially in an earthquake) or by settling in the foundation, and the ancient builders inserted a column during their repair work to support the ceiling.

I call this the kingship room because of the main themes found on the decorations. On the south wall we have numerous scenes of the king offering to gods, but also several where the king is being lead by the gods as part of the coronation ritual. There is also a scene of the gods Khnum and Ptah fashioning the king on a potter's wheel.

This scene is unique from ancient Egypt.

CASE HISTORY

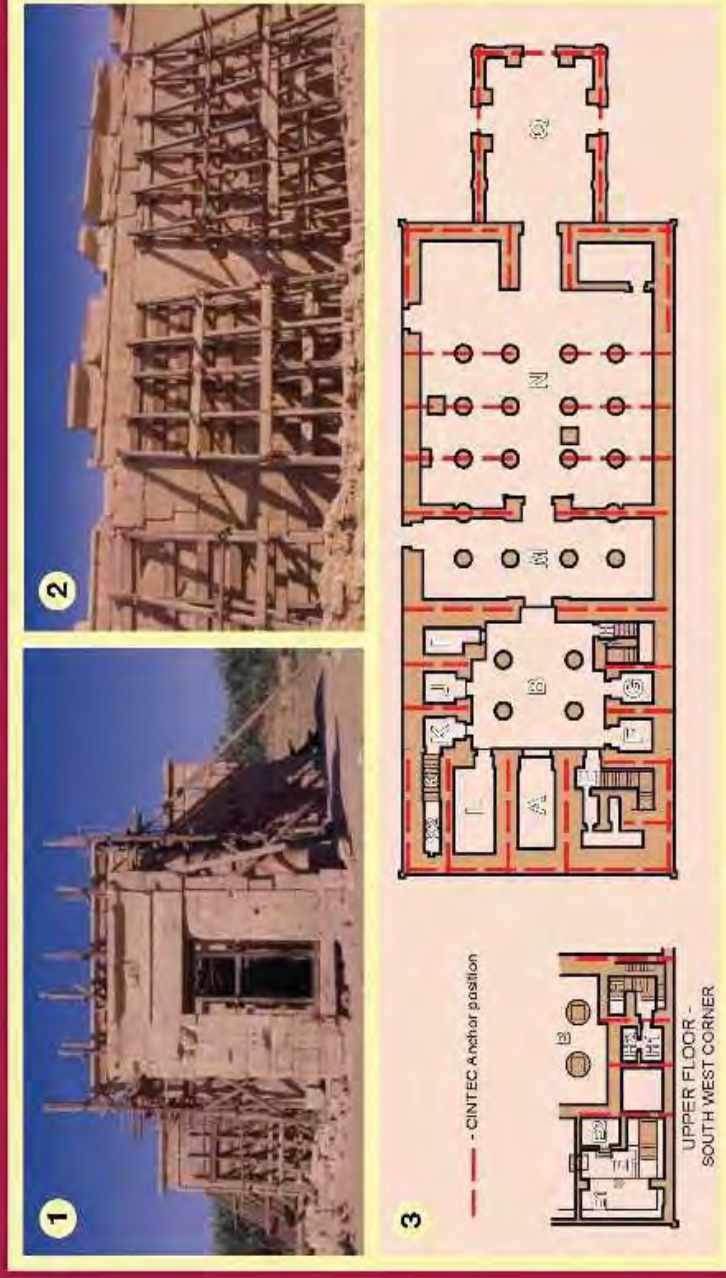

(1) The Portico

(2) The South Wall support

(3) The Position of the CINTEC Anchors

examination of Hibis Temple continued

The west wall is covered entirely by a scene of the king on his throne with Thoth and Horus tying the cords around the base of the scene in the "sematawy" ritual. This ritual signifies the unification of upper and lower Egypt in the person of the king. The entire north wall is covered by a long hieroglyphic text which is an acclamation of the king as Horus as well as being identified with a series of gods:

Shu, Geb, Osiris, Horus, Ptah-Sokar, Harshephes, Min-Re, Min-Horus, Min, Isis, Horuskhentyorty, Thoth, Maat, Khnum, Anubis, Anuris, Khonsu, Isis, Osiris, Horus, Nephthys and Neith.

Room K - K1 -K2 - Osiris - Re complex

The small chamber in the northwest corner next to room L is a series of a small rooms with a stairwell leading up to another chamber with a small pit. This room involves the rejuvenation of the god Osiris in the feast of Choiak. This is followed by the stairwell whose two walls are covered by two separate inscriptions.

The inscriptions on the north wall give a section of chapter 146 of the Book of the Dead converted to temple ritual use. Here the god Osiris is passed through the netherworld. This inscription is followed then by the south wall inscription where we have the god transformed into a sun god. This leads to the appearance of Osiris -Re in the back of the chamber above the pit and the associated scenes on the north and south walls worshipping

the resurrected sun god in his form as Osiris-Re.

Room I - A Storeroom

Room I is the chamber immediately to the right as you enter Hypostyle B; it juts out from the corner and parallels the stairwell on the south side of the area. It is the only room in this part of the temple which is un-inscribed on the inside. However, the series of inscriptions around the door tells us this room is a linen storage room. It stored the linen cloth used in the various daily rituals in clothing the god. The room has figures of the goddesses Tait shown as a snake headed woman. The inscriptions warn all those that enter the room to be ritually purified suggesting that touching the divine linen was reserved only for ritually purified priests who would perform the daily dressing ritual in the sanctuary. There is a parallel to this room found with similar inscriptions at Edfu temple.

Hypostyle B

The four columns dominate this hypostyle and provide access to the sanctuary and all of the connected rooms. Architecturally this chamber is not entirely unique, but is not completely paralleled at other temples which often separate the side chambers from direct access to the sanctuary area. In my investigations of the room I discovered that each of the four columns had been decorated in painted scenes of the king

offering to the gods. While most of these are mostly eroded, we were able to trace the outlines of most of the figures on all four columns. We also noticed that cartouches of the king in this chamber and all of the side rooms had been left blank at the time of construction except for two areas.

The first is up on the east wall where we have a scene of the king emerging from his palace (panel 2, south of door).

Here we have the Horus name of the king and it is identified as Psammethichus II (595-569 BC). The other area which has cartouches are on the reveals of the doorways. Here the name of Darius I (522-486 BC) is found carved in the cartouches.

When we look at the blank cartouches on the north and south walls we notice that some of them have paint in them (blue). Especially the cartouche on the top/first panel on the south wall where we have the king offering to Anuris and Tefnut. There the cartouche is fully painted in with the name of Darius.

In a separate publication I examined all of these cartouches and was able to determine that Psammethichus II was the king who built the main part of the temple and that Darius I commissioned the reworking of the front of the temple (later covered over by hypostyle N with its 12 columns).

One architectural anomaly in hypostyle B can be observed on the north wall. If one looks closely it appears that there is some "damage" along the upper course of stone.

CASE HISTORY

Close inspection reveals that when the stones were laid in place during construction, several of the stones had been improperly quarried too thick. Thus when the stones were put in position in the wall, they were levelled and adjusted using markings on the exterior side (this is clear when you go to the roof and examine these blocks).

After the work was done and the decoration of the interior walls began, it was discovered that these blocks stuck out 3-4 cm above the lower course of stones.

The workers then started to try and chisel the stone but quickly stopped after determining how much work it would be. They then simply chiselled off the lower section roughly and covered the area with white plaster and carved and decorated the scenes through the white plaster. Some of this plaster is still present on the walls.

Ancient Reconstruction of Hypostyle B

The next area to be discussed is the issue about the ancient fixing of the temple. As noted above in room L, there is a column just inside the door which blocks part of the decoration on the south wall. This column actually was part of a major reconstruction effort that took place, probably during the Ptolemaic period (based upon the style of capital in room L). For some reason (either from an earthquake or from dramatic settling of

the western end of the temple), a large group of cracks appeared going through hypostyle B. These cracks can be seen on the inside and outside of the temple running along a north-south line through the doors of rooms K and F.

Around the door to K on the north side of hypostyle B we can see a series of blocks that have been placed to replace the damaged left reveal/jamb of the door. There is no carved decoration, just traces of paint on the surface.

On the door to F (south side of hypostyle B) we can see major reconstruction. Portions of the door jamb/reveal have been chiselled out and would have been filled with plaster. In addition the lintel of the door has been replaced by a blank block without decoration.

Above both of these doors one can see the repairs made to the other blocks which had suffered damage in ancient times. If you go outside and examine the exterior walls at the spots along that north-south axis, you will see that in ancient times the temple had been repaired.

A series of blocks, all undecorated, have been fitted into the exterior wall at these positions indicating a repair of destroyed stones. This was noted in the elevation drawing provided as plate 35 in the Winlock excavation report by his gray shaded blocks.

There are several other areas on the north and south exterior walls that show the same ancient repairs. It seems quite clear to me that at some point, probably during the Ptolemaic period, the temple suffered some severe damage and the local officials received permission to repair Hibis temple. To do these repairs they mainly replaced damaged blocks on the interior and exterior with blank / undecorated blocks.

Those areas that had decoration they painted the decorations on the stone and did not carve them.

Some of this painted decoration from the repairs can still be seen, especially on the door jamb of the door to room K.

the strengthening solution

The condition of the temple was that the external south, west and north walls were temporarily shored with timber raking shores. There was significant rotation of the foundations because cultivation and irrigation of the soil adjacent to the footings had resulted in heave and shrinkage of the clay soils.

The installed drainage trench around the monument will prevent further disturbances in the soil around temple. Due to the nature and condition of this temple no vibration could be introduced in the drilling stage so dry diamond drilling techniques were used using compressed air to cool the drill bits and flush the dust from the holes.

The Cintec socketed anchor system prevented grout from damaging the delicate hieroglyphs that covered the internal and external walls.

It was decided to stitch all the elements of the temple to stabilise the walls and enable the timber raking shores to be removed. The large open spaces in the temple made it difficult to tie laterally across the temple so most of the internal walls were used to tie the external walls horizontally to the internal structure. The wealth of hieroglyphs on the walls contributed to the difficult location of the Cintec anchors.

All the walls were surveyed and the anchors were installed in damaged or missing areas of hieroglyphs.

The large areas of walls without internal walls were strengthened using inclined Cintec anchors 9m long from the top of the walls to the foundations, bridging the vertical cracks. Each corner of the structure was strengthened in this way in addition to horizontal anchors up to 10m long.

The temple was constructed in certain areas of two stones butted together to form the overall thickness of the walls, these had shown signs of delamination and were consolidated using Cintec stitching anchors, this tied the two leaves together creating a solid wall again.

The outer portico of the temple was also showing signs of movement so Cintec anchors were used horizontally and vertical. Anchors were installed into the columns to create an internal invisible frame.

Large new lintel stones were quarried from the original quarry and placed in their original positions over the columns in the outer hypostyle.

Cintec anchors were then installed through the outer walls and the new lintel stones laterally tying the north wall to the south wall.

The existing and rebuilt outer gateways were anchored horizontally through the roof slabs and vertically into each corner to add additional stability to the structures.

Several anchors were used throughout the structure to consolidate broken or cracked stones and slabs above internal rooms.

Upon completion the external raking shores were removed allowing the structure to be viewed unsupported for the first time in many years.

CASE HISTORY



(1) Securing the Ground
(3) The finished hole ready for the anchor

(2) Drilling for the Anchor
(4) Inserting the CİNTEC Anchor

the ground solution

The main problem affecting the temple was the amount of ground and surface water that ingressed into the temple foundations causing differential movement of the structure.

This together with poor soil conditions caused serious structural problems in the temples superstructure. Normally, the pharonic constructors were very good at understanding the need for good foundations and it is a mystery why this temple was built on poor foundation conditions.

Solving the ground condition was the first priority. The local farmers were restricted to work at a safe area from the temple to reduce the amount of surface water entering the temple.

However, the main task was to isolate the main structure from the subsurface water by using a trench one metre wide and up to seventeen metres deep to completely surround the monument and make it a dry island in an oasis.

To overcome any water that might enter under this barrier a series of lime piles at four metre centres some up to seventeen meters deep were formed through the entire temple at ground level to absorb any other water penetration.



CASE HISTORY

1

NORTH ELEVATION

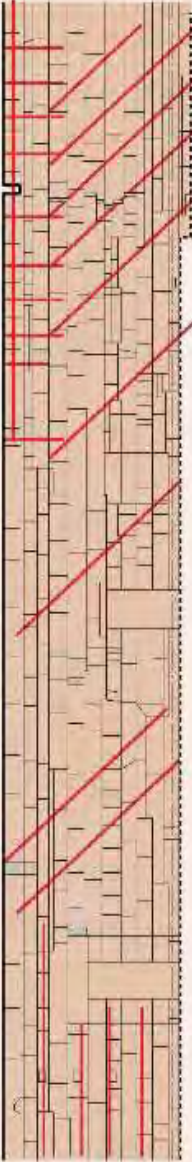

(1) View of typical anchor arrangement to stabilise the outer walls of the temple. Each anchor position was carefully designed to satisfy the engineering requirements, but also were extremely sensitive to the delicate hieroglyphs adorning the temple

2

قبل الفك



(2) The original, supported corner

3

بعد الفك



(3) The finished, secured corner

CASE HISTORY

WALL TIE REPLACEMENT, CARDIFF



Black ash mortar was used in the construction of many houses in Cardiff and other regions in the United Kingdom. Ingress of moisture through the external brickwork leaf and mortar causes the formation of acidic agents which cause corrosion of the wall ties. Particularly at risk from corrosion are the zinc-coated wall ties which have been traditionally employed in UK housing.

The Cintec RAD replacement wall tie was specifically developed to overcome the problems associated with black ash mortar and tie corrosion. Removal of the existing wall ties is the preferred solution because if the wall ties are bent-back further corrosion can lead to damage to the finishes on the internal skin of brickwork, due to the expansive forces caused by the corrosion.

The existing ties were located using a metal detector. They were over-drilled using a 60mm diameter over-coring drill and removed. The 60mm diameter Cintec RAD anchor was installed based on 10 x 1mm CHS stainless steel section with socks at either end in the external and internal walls. Grout was injected under pressure and the external skin was made good to match the existing brickwork.

The photograph of a typical house in Butetown, Cardiff is typical of the use of Cintec RAD anchors. In Cardiff, over 500,000 RAD anchors have been installed in the housing stock, thus securing the continued life of the housing and removing the problems associated with corrosion of zinc-coated galvanised steel wall ties.

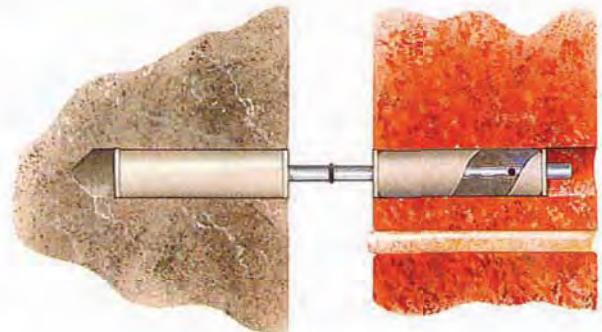

Supplementary wall tie

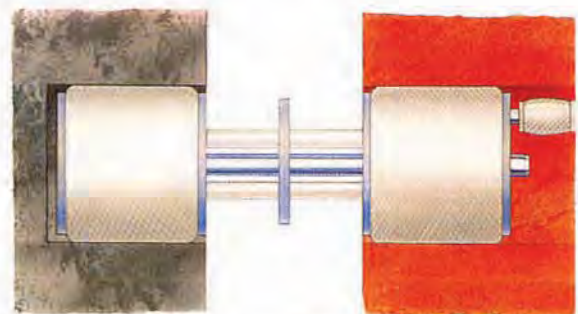

Replacement wall tie

CASE HISTORY

AURTHERS COTTAGE: BALLYMENA, NORTHERN IRELAND

CINTEC HARKE ANCHOR

REPAIRS TO ARTHUR COTTAGE



CASE HISTORY



Arthur Cottage, the Ancestral Home of Chester Alan Arthur, 21st President of the United States has recently been opened to the public.

Before this, a survey had indicated that two external walls showed signs of moving outwards. (see photograph)

Before the cottage could be opened to the public it was necessary to reinforce these external walls to prevent further movement.

Obviously to preserve the character of the cottage, no external Patching Plate could be used, this presented a problem as there did not appear to be any way of doing the job satisfactorily.

Ace Fixings were approached and suggested the Cintec Harke WSA stitching anchor for the following reasons:-

- (1) After painting, no external signs of repair would be visible thereby preserving the original character.
- (2) The cementitious grout nature of the anchor would mean that a good fix can be obtained in a rubble filled wall.

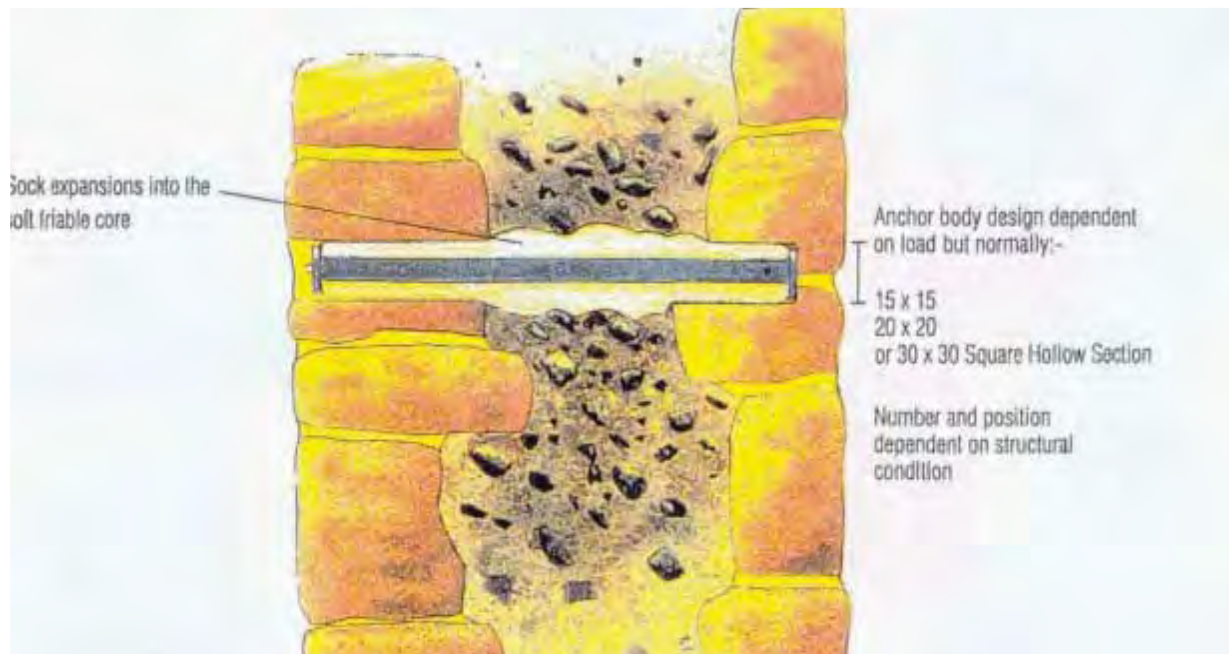

CASE HISTORY

- (3) The stress free nature of the anchor means no stresses are exerted on the structure.
- (4) The WSA anchor is quickly and easily fixed in place.
- (5) The anchor is unaffected by any dampness or moisture within the stone wall.
- (6) The metal components of the anchor are all stainless steel ensuring a very long life.

This suggestion was accepted by the Architect and two 30mm x 30mm x 450 long WSA anchors were installed tied together with 16mm rod, tensioned using two bottle screws.
(See diagram below)

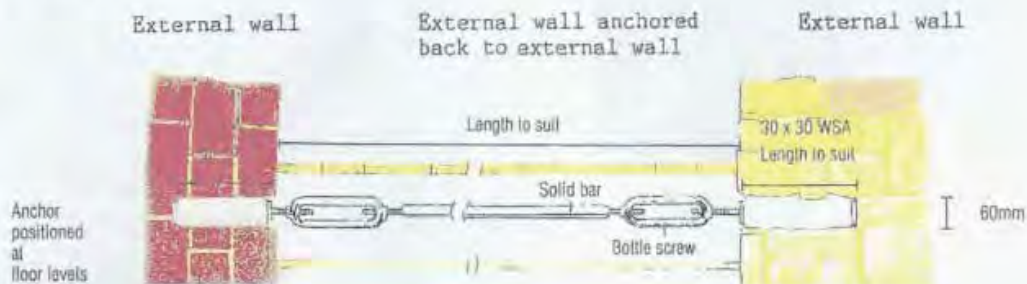

INSTALLATION

The anchor is installed into a 60mm diameter hole drilled with a Diamond Drilling Rig.



(a) Drilling Rig Base Plate fixed to wall.

CASE HISTORY



(b) Drilling Rig in place.

(c) Drilling one of two 60mm holes.



(d) Installing the anchor.

CASE HISTORY



(e) Inflating the anchor with grout. (Note the photograph taken of the actual operation did not come out).



(f) Internal view of one installed anchor with the bar (connecting to the other anchor) and showing the bottle screws.



(g) The finished wall after installation of anchor and before white washing.

For further details and quotations contact:



38 Auriga Drive, Suite 200 Nepean
Ontario, Canada K2E 8A5
Tel: (613) 225-3381 Fax: (613) 224-6055

CASE HISTORY

WILLSON CARBIDE MILL, VICTORIA ISLAND OTTAWA, ON, Canada



Inventor Thomas Willson developed a process for producing calcium carbide in 1892 and founded the Ottawa Carbide Company. He sold the American patent for the process to a firm which later became the Union Carbide Company. He built a mill on Victoria Island between 1899 and 1900 to produce acetylene gas (a product of calcium carbide). The building, which Willson helped to design, was attractive in appearance (with stone exterior) and innovative in design.

By 1971 the NCC (National Capital Commission) had acquired the property around the mill for recreational use and in 1972 the mill was designated as a "recognized" building by the Federal Heritage Buildings Review Office (FHBRO).

This project (as part of the Infrastructure Stimulus Fund) began in spring 2010 and includes work within Phase 3 of the stabilization/rehabilitation work at this site, following the completion in fall 2009 of Phases 1 and 2. As in prior phases, the Cintec Anchoring System was chosen by DMA, Les Architectes Desnoyers Mercure et associés (Christine Lacroix) and Adjeleian Allen Rubeli Ltd., Consulting Engineers (Derek Mes, P.Eng. M.A.Sc.).

The stabilization of the East wall corners and the stabilization and stitching of the East and North walls was carried out by masonry contractor De Marinis (DMA) Inc (Mario L. De Marinis, President.). De Marinis had used the Cintec system for almost 20 years, on several projects, and was therefore very knowledgeable on its ease of use and capabilities. In this case, over 1,000 Cintec anchors were installed in lengths from 21 inches to over 15 feet long.



<p>ARCHITECT DMA, DESNOYER MERCURE 655 Rue Desnoyers Suite 204 Montreal, Quebec, Canada (514) 288-4251</p>	<p>CONTRACTOR DE MARINIS (DMA) INC 56 Bentley Avenue Ottawa, Ontario, Canada (613) 226-1550</p>	<p>ENGINEER ADJELEIAN ALLEN RUBELI LTD 75 Albert St. Suite 1005 Ottawa, Ontario, Canada (613) 232-5786</p>
--	---	--

CASE HISTORY

STOWE HOUSE, BUCKINGHAMSHIRE

Sister to Buckingham Palace



Originally the country residence of Lord Buckingham, Stowe House has long been the home of a leading public school (that is a school funded by private fees). The wall construction is an external leaf of Bathstone with rubble infill and an internal masonry wall, having an overall thickness of up to 1150mm. A length of this wall was to be stabilised by grouting the rubble infill. However, the wall required strengthening to withstand the pressure of this grouting.

The solution was to install Cintec 20 x 2 CHS stainless steel anchors in a nominal 40mm diameter drill hole of centres in the range 750-900mm. Anchor lengths of 850mm and 1075mm were employed to cater for the variable wall thicknesses. To maintain the external appearance, all anchors were installed from the inside of the building. They were allowed to project into the building to permit the standard circular crimped anchor body. The anchor projection was cut off flush internally and plastered over.

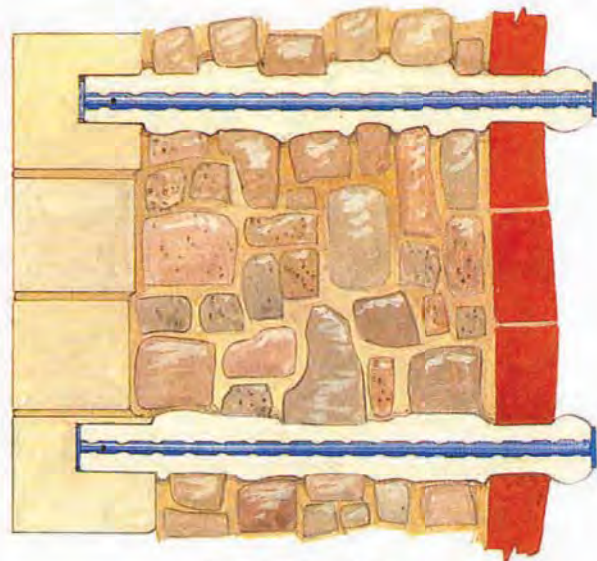

Section through external wall

CASE HISTORY

The Jealous Wall Folly , Southern Ireland

Now owned by Westmeath County Council and due to be part of a new Visitors' Centre, this remarkable folly was built in 1760 and originally constructed to look as though it was a 200 year old ruin.

Some 55m long and up to 20m high, it was erected by Lord Belvedere to block the view of his estate his neighbor and brother, George Rochfort, whom he accused of having an affair with Lady Belvedere.



Problem

Despite appearing seriously unstable, with an erratic and uneven line of pinnacles listing off plumb and various openings looking ready to collapse, the bulk of the structure was in fairly good condition. However, spreading ivy had shifted large sections of stonework and weathering had greatly affected much of the original lime mortar, to the point of failure in some areas.

Full structural integrity had to be sympathetically restored without disruption to the original fabric.

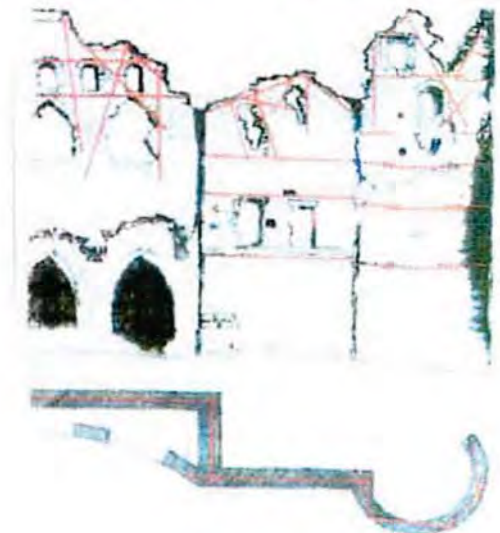

Solution

A programme of concealed repairs was devised by the structural engineer. Initially all ivy and other vegetation was removed and the wall jet washed before temporary repairs were carried out.

Precision diamond core drilling was undertaken horizontally, vertically and at various angles to allow the installation of Cintec grouted stainless steel anchors up to 14m long. The accuracy of this drilling was crucial. In several instances two 65mm diameter core holes, which had to be a minimum 50mm from the wall face, were drilled through the 300mm thick wall while allowing a horizontal anchor to pass unhindered between them.

All voids were then grouted, pinning stones refixed and extensive lime mortar repointing carried out to fully restore and secure the Jealous Wall while retaining its original 'unstable' form.

CASE HISTORY

FENCHURCH STREET RAIL STATION, LONDON, U.K.



Cantilever Signal System



Viaduct

Fenchurch Street Station is one of London's busiest rail stations; it is the start point and terminus for the main tracks from the South of the U.K. to London. The construction itself is a remarkable example of Victorian 'railway' Architecture and was built at the height of rail travel era. The tracks carrying the service to the station travel over a Victorian Viaduct, comprising a series of arches. These arches support the cantilever system of signalling that guide trains to and from the station. The structure is a large steel gallows extending out over the track, with the signalling system suspended from it. The engineer had to recognise that any work on the structure had to address the problem of a live track running overhead.

The Problem

A system was required to secure the gallows to the bridge arches; in their preliminary planning, Railtrack anticipated a shut down of the tracks for 6 weeks. Such a closure would mean a chaotic time table, irate passengers and a loss of revenue. The CINTEC Anchoring System proposal provided a solution that would require only 2 days of rail shut down.



The torquing of the anchors



The assembling and installation of a compression anchor

CASE HISTORY

FENCHURCH STREET RAIL STATION, LONDON, U.K.

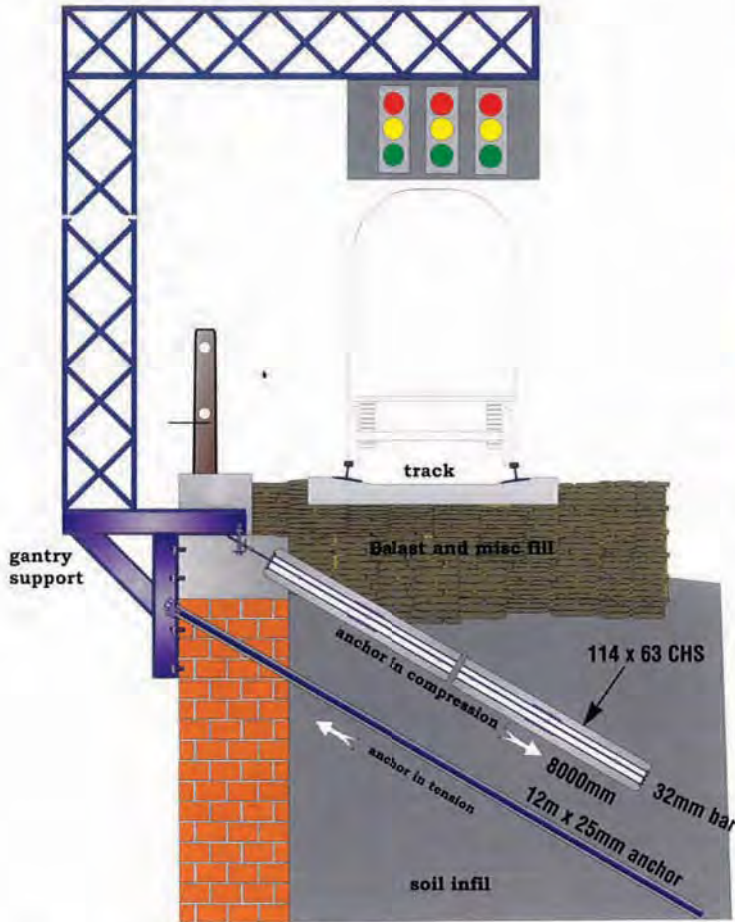

FOUNDATION DETAILS OF ANCHOR ARRANGEMENT TO SIGNAL CANTILEVER FOR BRITISH RAILWAYS AT FENCHURCH STREET STATION LONDON

The Solution

The proposed solution involved three CINTEC Anchor types. The central one was a compression anchor of stainless steel comprising a 32mm shell rebar inside a 114 x 6.3 CHS installed in a 200mm hole, 8000mm deep, at an angle of 30 degrees to the horizontal. Below it was a tension anchor, comprising a solid stainless steel body, 12m x 25mm installed in a 50mm drilled hole, and attached to the gantry support to prevent any rotation. Two smaller shear anchors 20mm x 800mm were similarly installed to complete the support. Load tests were carried out, with the placing of a 20m steel beam in position.

As a result of the use of a CINTEC installation, disruption was reduced from 6 weeks to 2 days together with a 50% saving on the original budget Railtrack had allocated to the project.



Shear anchors shown at the top and tension anchors at the bottom

Testing



In shear



In tension



THE STUD ANCHOR

The Threaded Studding Anchor is used for fixings and fastenings and for the stabilisation of the substrata into which they are embedded. Studding Anchors are produced as both stainless and ferrous reinforcements and in diameters ranging from 8mm to 39mm as required. These applications range from the retaining of plaster reliefs in the ballroom of Buckingham Palace to the fixing of 4 tonne plates which carry the shear loads at Deansgate Locks in Manchester. High-rise projects include bonding attachments to the concrete shaft at St John s Tower in Liverpool and facade panel securements to Fitzwarren Court in Salford.



Deansgate Locks - Manchester

A variety of adaptations in the design of the Studding Anchor can be made in order to:

- Withstand rotational crushing of the grout field and the substrata where the stud anchor exits the wall by the addition of internal plates. See Fig 1.
- Oppose the rotational torque forces encountered while tightening fastenings and attachments by the addition of a piece of small diameter Re-bar. See Fig 2.
- Increase the cone of resistance by the addition of an end plate.
- Increase diameter of sock to allow good fastenings in poor quality substrata or hollow pot structures and to be used in large diameter holes to minimise stresses in the parent material.

St John s Tower - Liverpool

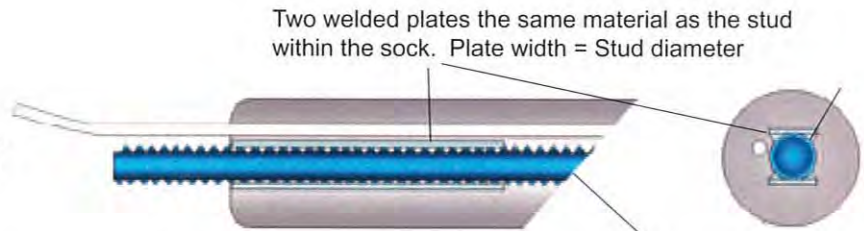

Figure 1

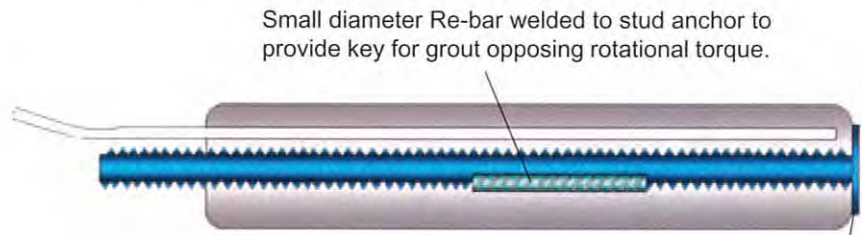
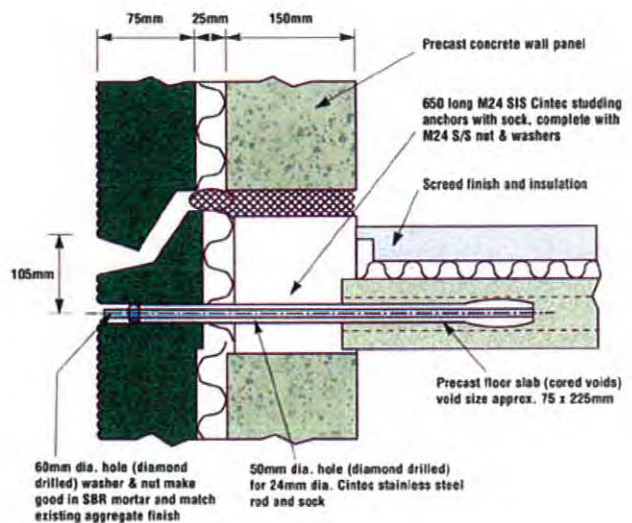

Figure 2

Hollow pot application - Fitzwarren Court - Salford



STUD ANCHOR APPLICATION

Stud Drop Anchor

Heathrow Airport Example

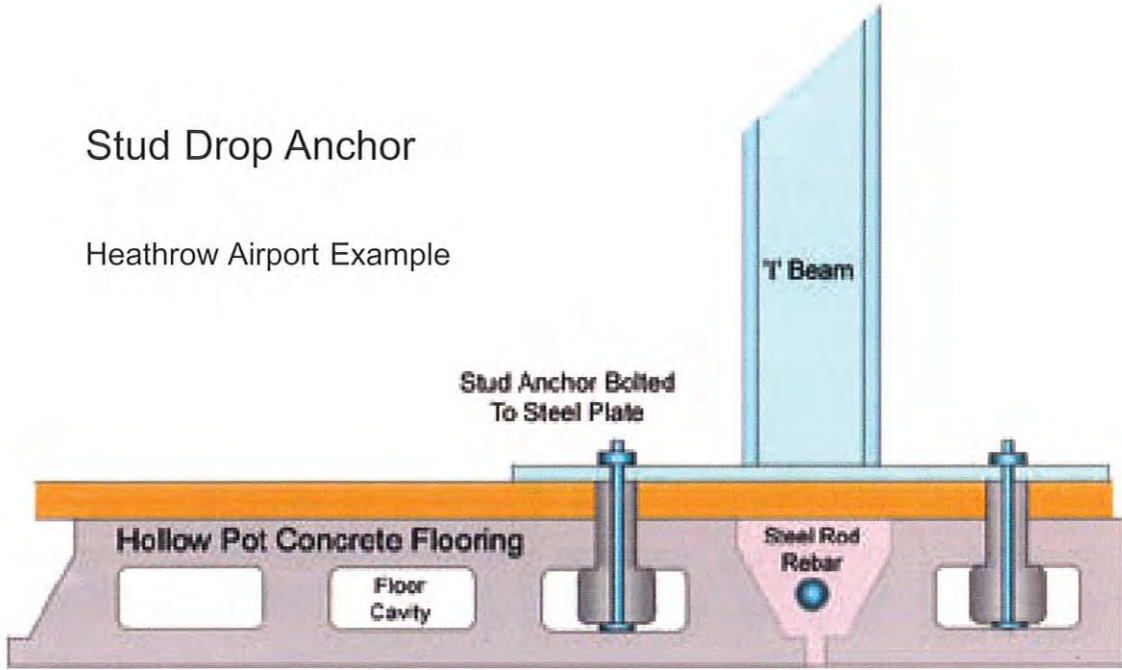

Wall Plate Fixing Detail

Court Farm Barn
Example - Winterbourne

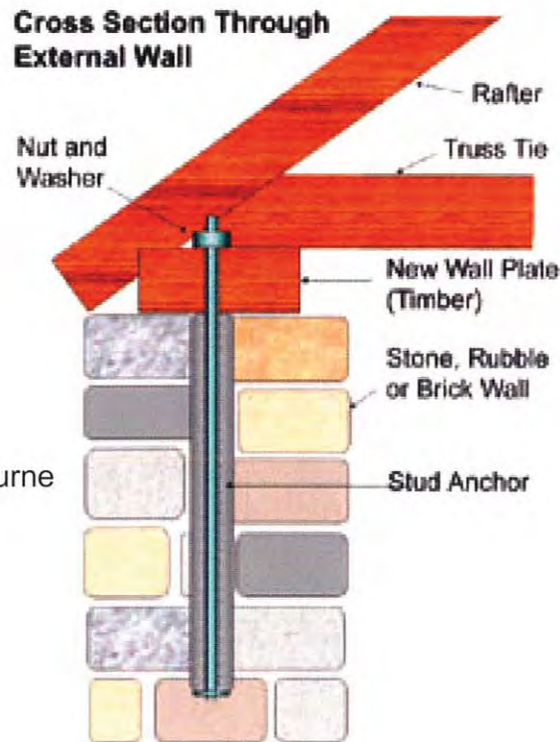

Stud-welded Masonry Retrofit Anchor System

The Prudential Building Chicago



The Chicago Jewelry Exchange



Stud-welded Masonry Retrofit Anchor System

Designed to restore lateral tieback to the supporting steel frame, the nelson® stud-welded masonry retrofit anchor has been successfully installed in repair applications to restore structural integrity to damaged or deteriorating masonry systems. Combining two diverse material technologies, CINTEC's R&D department working with Boyd Associates, Inc. developed a masonry retrofit anchoring system which combines welded steel studs with the CINTEC® retrofit masonry anchor system.

The system is installed by first drilling small holes through the masonry to the surface of the structural steel member. A separate bit is then used to lightly mill away any surface rust or buildup on the surface of the steel member. A threaded stud is then fusion welded onto the steel member using a special adapter mounted on the standard stud gun. Following stud installation, a standard CINTEC® masonry anchor with a special adapter is threaded onto the stud and completed in the standard manner.

This anchoring system has been used to restore ties to brick and terra cotta in situations which would have otherwise led to more extensive and costly removal. Current applications have included both short term and permanent repair of masonry in which the original tie materials were either missing or severely deteriorated. In situations where eventual removal may take place in the future, the threaded studs can remain as the permanent structural tie for the new masonry.

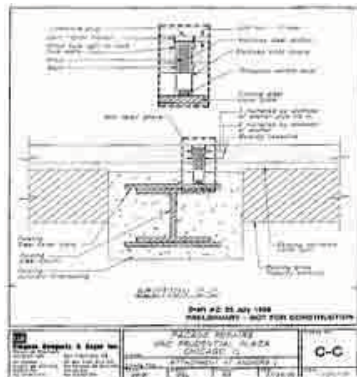

Engineers for the Chicago Jewellery Exchange

Jon M. Boyd Consulting
Structural Engineer

Engineers for the Alternative Repair System

to the Prudential Building
Simpson Gumpertz & Heger Inc.
Consulting Engineers

Barking High Rise - Gas Explosion Protection



The dangers of a gas explosion in high rise blocks are appreciated far more now than when many of the buildings were originally constructed. In acknowledging this inherent danger, Barking Council decided to reinforce the concrete end panels on a number of its highrise properties. Gas meters located on the inside of the external end walls were a cause for concern as a gas leak is more likely at one of their pipe connections. In the worst case, an explosion could cause a 'house of cards' effect from a progressive collapse. Cintec anchors provided a solution which fixed the external panels to one another and also to an inner wall via the insulation cavity of the hollow concrete flooring. Extensive insitu load testing on the 33.4mm diameter, 7000mm long stainless steel tube anchors proved a loading of 240kN was possible, more than double the 105kN required strength. The smaller external load transfer anchors also performed well beyond their required parameters. The anchor ensemble was held together by a 250mm diameter plate welded to the external end of the tubular anchor. The inner end of the anchor was locked to the internal wall by means of a 1400mm long grout filled sock that expanded into the floor cavity beyond the diameter of the drill hole on both sides of the wall in order to provide the strong mechanical bond achieved in testing (see diagram below for full anchor ensemble). In all several hundred Cintec anchors were installed by WT Specialists Ltd and the project was completed in 1996.

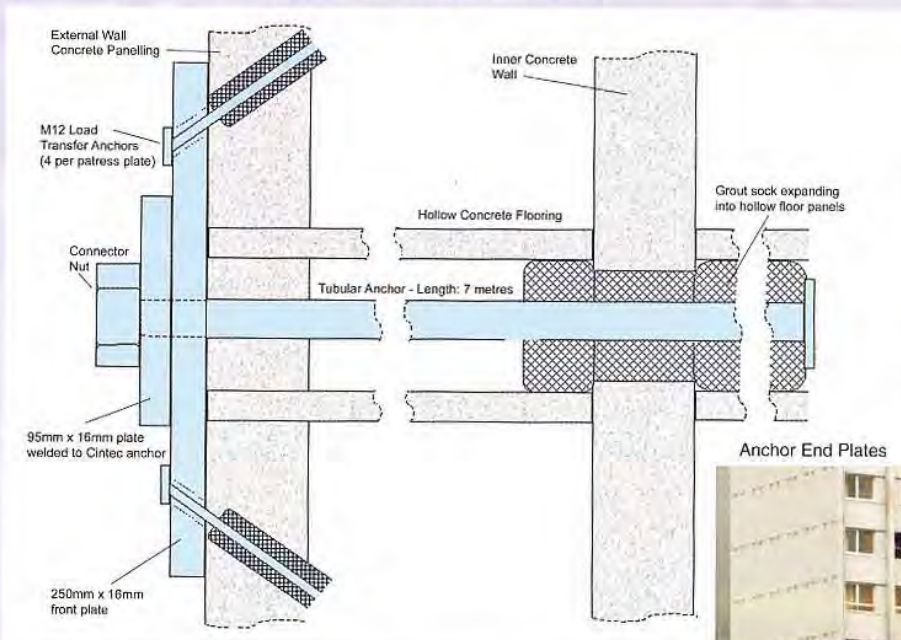



The Commission of New Town wished to enhance the robustness of 400 No. houses and 200 No. 3-4 storey apartments, particularly against the effects of accidental damage. The Cintec anchor was adopted primarily on the basis of cost-effectiveness and least disturbance to the tenants.

Enhanced robustness was achieved by the installation of stitching anchors 6m long tying the front and rear elevations. It required the development of dry drilling

techniques and carefully co-ordinated management so that tenants were only required to absent from their properties for one day between 8.00am and 6.00pm. The anchors passed through concrete hollow floors with careful control of level. Special socks and grout pressures were designed for the particular application. Particular attention was paid to keeping tenants informed and to meeting their individual requirements. As a result all the work was completed within cost and programme to the satisfaction of the clients and tenants.



Section through hollow floor

Preservation Technology **Cutting-Edge Masonry Repair**

Steering away from epoxies, new technologies help patch, clean, straighten, and strengthen historic brick and stone buildings

By Eric Adams

If masonry is one of architecture's true constants, masonry repair is one of historic preservation's. Brick and stone are among the most versatile and durable building materials, but they're prone to wear and damage from wind, rain, and all manner of human assault.

Fortunately, historic preservation specialists and product manufacturers are working to stay ahead of masonry decay. Several innovative new technologies help in virtually every area of masonry repair, including strengthening, repointing, cleaning, connectivity, and void and crack repair. These methods range from advanced anchoring systems and sophisticated cleaning devices to carefully prepared and applied mortars and grouts.

Although new repair techniques sometimes introduce modern materials into historic fabric, they are all designed to aid historically faithful preservation efforts while supporting necessary cosmetic and structural repairs. The techniques respond to the concerns of architects, conservators, and contractors about an historic building's ability to breathe and move naturally. They also resolve more general issues of material and historical fidelity. In particular, experts are shying away from chemical-based

fixes, such as epoxies or resins, and from high-strength mortars, both of which can damage buildings more than the forces they are trying to correct.

"Compatibility is the key when fixing old masonry," explains Michael Schuller of Atkinson-Noland Associates, a masonry evaluation and repair consultant in Boulder, Colorado. "If you place a really stiff material, such as mortar, next to a softer material, you'll likely get cracking and spalling in the masonry. If there's an epoxy barrier, you'll have water-vapour transmission problems."

Strengthening masonry walls

Perhaps the most dramatic recent advancements in masonry preservation technology focus on strengthening and connectivity. In the face of seismic forces, wind loads, vibration from vehicles and machinery, inadequate original design, new adaptations, and aging, stabilising masonry is becoming a more critical element of rehabilitation and historic preservation efforts.

Cintec Designed Anchor Systems offers an innovative alternative to invasive or unsightly structural strengthening systems.



Limestone cladding of Essex County New Courts Building and Jail was one accident away from catastrophic failure. More than 20,000 Cintec anchors now prevent masonry's collapse.

The Cintec Anchor system is embedded within masonry walls and can be installed with relative ease and speed. In most cases, there is no need to evacuate a structure during installation.

Developed in the United Kingdom and instrumental in the recent post-fire restoration of Windsor Castle, Cintec anchors, manufactured by CLS Cintec, are deceptively simple. A steel rod wrapped in a fabric sock is inserted into a predrilled hole in the masonry. Once in place, ultrafine concrete grout is pumped into the sock. As the anchor fills, grout milk is forced through the

To install Cintec anchor (right), technicians drill hole, insert nylon sock-covered anchor, and inject grout into sock until anchor is securely wedged into masonry.



sock, creating a chemical bond between the anchor and the substrate. The exterior hole is then patched. The wall is then better able to withstand vertical forces and is generally stronger.

"One of the best things about this system is that the material is cementitious, not epoxy-based," explains Westfield, New Jersey, architect Michael Zemsky. "The most interesting part is that the nylon sock expands to fill the cavity until it is completely wedged in." Zemsky recently specified Cintec anchors on the Essex County New Courts Building and Jail in Newark. The 1966 building's limestone curtain wall panels had separated from the structure, causing damage so pervasive and severe that the building was, in Zemsky's words, "one accident away from catastrophic failure."

Zemsky's general contractor for the courthouse project, Jim Papandrea, says that before they inserted more than 20,000 Cintec anchors into the building, they had an independent lab test the system by measuring the strength of the anchors' hold on the masonry. "The pullout tests exceeded 4,000 pounds," Papandrea says of the procedure, in which steadily increasing force is applied until the anchor fails. "The block broke before the anchor did."

Cintec anchors are available in lengths ranging from 6 inches to hundreds of feet, and can be applied either front to back or lengthwise through a masonry wall. Variations of the system can also stitch together heavily cracked masonry and connect outer external wythes to internal

wythes. The anchors also provide cost savings: Their use in the Newark courthouse project saved the client \$2.5 million over a previous estimate for reanchoring the building's dangerously unstable stonework.

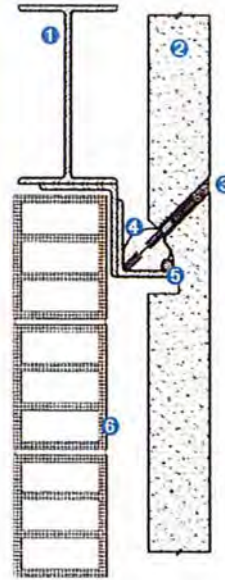

- 1 structural steel beam
- 2 limestone panels
- 3 Cintec anchor
- 4 expandable nylon sock
- 5 steel relieving angle
- 6 masonry backup
- 7 patching compound
- 8 grout flood hole
- 9 stainless steel member
- 10 end plate

Wall section detail

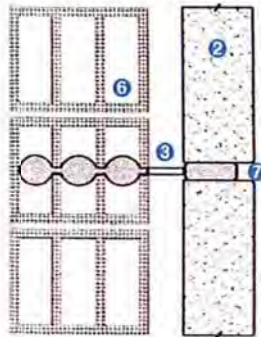

Wall plan detail

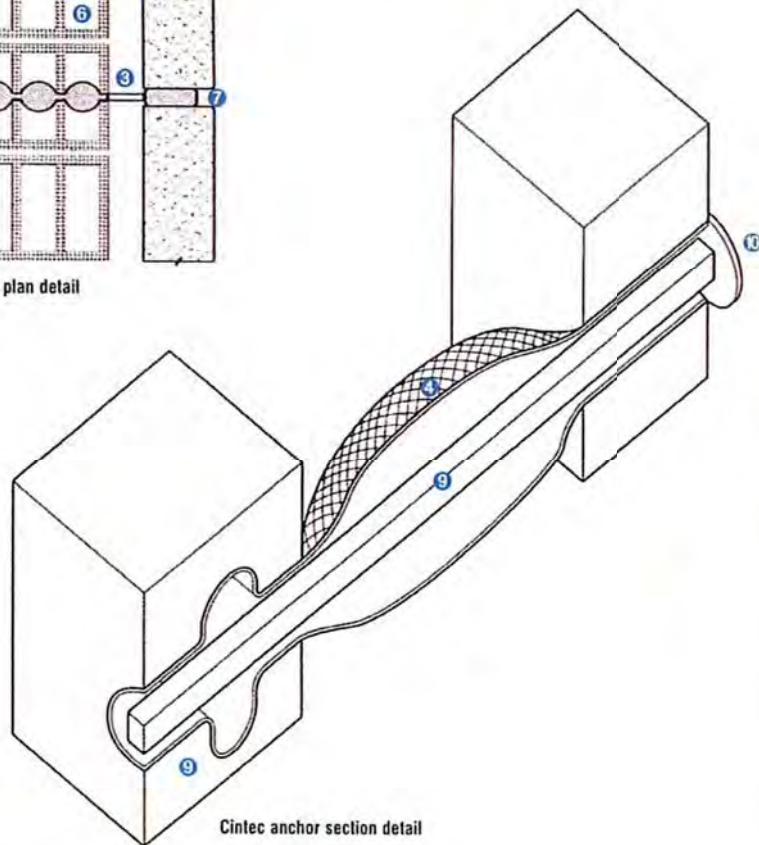

Cintec anchor section detail



On Historic Preservation

Spring 2012

Saving a Landmark

By Robert J. Nacheman, P.E. (RNacheman@ThorntonTomasetti.com)



The colossal order of columns (a multi-story order of columns) is a signature feature of the building.

Cornelius Vanderbilt's grand headquarters for the New York Central Railroad was in trouble: The 1929 NYC landmark building at 230 Park Ave. had vertical cracks at its corners. Previous repair design by others had been estimated at \$15 million. Thornton Tomasetti was hired to evaluate the conditions of the 34-story building's façade walls and recommend appropriate and cost-effective repairs.

To correlate the degree of cracking visible at the surface with the amount of subsurface corrosion, we conducted invasive probes at the building corners and terra cotta enclosed decorative façade columns and brackets. Pulse echo scans were also performed on the terra cotta brackets to identify internal cracking.



Grout being pumped into the terra cotta anchor assembly to engage and stabilize terra cotta units.

A finite element stress analysis model of the terra cotta brackets was developed to better understand the cause of the cracking, and guide the necessary corrective action.



Pulse echo scanning of terra cotta.

We specified stainless steel anchors set in pressure-grouted fabric socks in the cracked terra cotta brackets, and stainless steel staples at the building's corner cracks.

A cathodic protection system was installed at the most severely corroded laced steel columns inside the terra cotta enclosures to minimize and monitor corrosion. The repair was accomplished at half the expected cost, with sensitivity to historic preservation requirements. Our approach showed that technology can be effectively applied to historic building assemblies with significant savings in repair cost.

CASE HISTORY

High Rise Building Restoration

HEMSLEY BUILDING 230 PARK AVENUE, NY, NY U.S.A.: TERRACOTTA REPAIR



The Property

This “recognized iconic asset” to the New York City Skyline is located in midtown Manhattan and was built as a Beaux-arts style building in 1929. The property strategically straddles Park Avenue at 46th Street and offers a direct connection to Grand Central Station. It was acquired (2007) for One Billion One Hundred and Fifty Million USD.

The Problem:

By 2009, the building had begun to show its age. At the top of the building some of the twenty-six east and south facing Terra-Cotta columns [with the base starting at the 26th floor and extending past the 34th floor] had begun to show cracking and in some areas had begun to shed large pieces of stone. The building owners/management had inquired as to replacement cost of these Terra-cotta Brackets and had been quoted prices exceeding 16 Million dollars. By employing the Cintec method of repair, the owner was able to save more than 15 million Dollars effecting by repairs for just over 1million dollars.



The Solution:

CASE HISTORY



Cintec in North America was contacted by Thornton Tomasetti Engineering Corporation to find a solution to this issue, working together Cintec North America and Tomasetti Engineering Corporation formulated a plan. Through exploratory probes and use of a borescope it was assessed that the structure behind the columns (staked brick) was sound, given this assessment it was decided that all that would be needed would be to attach the Cintec Anchoring System to the backup and tie it to front face of stone that was sound in order not only to strengthen the attachment to face but to create additional points of contact in the stone face brackets that were sound. This was achieved by drilling oversized holes through the face of the stone and recessing the anchor 1" from face of stone to accommodate a finish patch, thus creating an invisible repair. The ability to tie the face of the original Terra-cotta panels to the back up wall saved the integrity of the landmark building.

Savings:

By affecting, this repair method as opposed to fiberglass replacement and demolishing landmark terracotta brackets and columns, the owner was able to save more than 15 Million dollars and effect repairs in less than a quarter of the time needed to replace brackets. The General Contractor on this project was United Restoration Corp who worked closely with Cintec North America, Thornton Tomasetti (Engineer of Record) and Arteco Design Corp (Driller/Installer) to complete this project with minimal issues and maximum savings.

General Contractor
United Restoration Services of
NY
295 Greenwich St, Ste 341
New York, NY
10007
Tel: 212-431-1261

Engineer of Record
Thornton Tomasetti
24 Commerce Street, 8th Fl
Newark, NJ
07102
Tel: 877-993-9737

Specialist Masonry Contractor
Arteco Design & Restoration
8 Bogart Place
Yonkers, NY
10708
Tel: 914-793-9424

PARC OMEGA, QUEBEC, CANADA

UNUSUAL APPLICATION



Cintec was called on, by a Regional wild life park, for a solution to their need to join and stabilize large tree trunks that made up its unique entrance arch. Concrete footings were formed and poured as the base at each column and at the same time a stainless steel rod was placed in the centre of the base and allowed to protrude upward some 5 feet. The trunks were hollowed out, banded (to prevent splitting as the timber dried), and then carefully placed over the rods and allowed to rest on the base ensuring a seal between wood and concrete. Fill and vent ports were drilled from the outside of the tree trunks into the hollow chamber and Cintec Presstec Grout was carefully injected and left to cure. Afterwards the holes were made good by inserting wood plugs resulting in a near invisible installation.





CINTEC
Reinforcement Systems



United States

Cintec America Inc.
200 International Circle, Suite 5100,
Hunt Valley, Maryland
21030, USA

Tel: 1 410 761-0765
1 800 363-6066
Fax: 1 800 461-1862
E-mail: solutions@cintec.com

Canada

Cintec Reinforcement Systems
38 Auriga Drive, Suite 200
Nepean, Ontario, Canada
K2E 8A5

Tel: (1) 613 225-3381
Fax: (1) 613 224-9042
E-mail: solutions@cintec.com

United Kingdom

Cintec International Ltd.
Cintec House
11 Gold Tops
South Wales, UK
Newport NP204PH

Tel: +44 (0) 1633 246614
Fax: +44 (0) 1633 246110
E-mail: hqcintec@co.uk

Visit our website for up-to-date
information and test data together
with information on the various
projects carried out worldwide.

www.cintec.com